



Neue Teile im Lager

nach Kfz-Verwendungen

05/2014

www.ate.de



Original AT
Original AT
Pieces d'O
Repuestos
Ricambi O
Original AT



Bezeichnung

OE-Nummern
zu ATE
Artikelnummern



z.B. Vorsachnummern /
diverse

AUDI

| | | | | | | | | | |
|---------------------------|------------------|---------|---------|---------|----------------|--------|----------------|--|--|
| A1 / A1 Sportback (10-) | 1,2 TFSI | 3) Coup | 05.2010 | | 24.2519-1706.3 | 040096 | NEHMERZYLINDER | 6Q0 721 261 F, 6Q0 721 261 D, 6QE 721 261, 5Q0 721 261, 1U0 721 261 A, 6Q0 721 261 A | |
| | 1,4 TFSI | 3) Coup | 04.2012 | | 24.2519-1706.3 | 040096 | NEHMERZYLINDER | 6Q0 721 261 F, 6Q0 721 261 D, 6QE 721 261, 5Q0 721 261, 1U0 721 261 A, 6Q0 721 261 A | |
| | | 3) Coup | 05.2010 | | 24.2519-1706.3 | 040096 | NEHMERZYLINDER | 6Q0 721 261 F, 6Q0 721 261 D, 6QE 721 261, 5Q0 721 261, 1U0 721 261 A, 6Q0 721 261 A | |
| | | 3) Coup | 11.2010 | | 24.2519-1706.3 | 040096 | NEHMERZYLINDER | 6Q0 721 261 F, 6Q0 721 261 D, 6QE 721 261, 5Q0 721 261, 1U0 721 261 A, 6Q0 721 261 A | |
| | 1,6 TDI | 3) Coup | 05.2010 | | 24.2519-1706.3 | 040096 | NEHMERZYLINDER | 6Q0 721 261 F, 6Q0 721 261 D, 6QE 721 261, 5Q0 721 261, 1U0 721 261 A, 6Q0 721 261 A | |
| | 2,0 TDI | 3) Coup | 09.2011 | | 24.2519-1706.3 | 040096 | NEHMERZYLINDER | 6Q0 721 261 F, 6Q0 721 261 D, 6QE 721 261, 5Q0 721 261, 1U0 721 261 A, 6Q0 721 261 A | |
| | 2,0 TFSI quattro | 3) Coup | 10.2012 | | 24.2519-1706.3 | 040096 | NEHMERZYLINDER | 6Q0 721 261 F, 6Q0 721 261 D, 6QE 721 261, 5Q0 721 261, 1U0 721 261 A, 6Q0 721 261 A | |
| A2 (00-05) | 1,4 | 3) Coup | 06.2000 | | 24.2519-1706.3 | 040096 | NEHMERZYLINDER | 6Q0 721 261 F, 6Q0 721 261 D, 6QE 721 261, 5Q0 721 261, 1U0 721 261 A, 6Q0 721 261 A | |
| A3 / A3 Sportback (03-13) | 1,2 TSI | 3) Coup | 04.2010 | 08.2013 | 24.2519-1706.3 | 040096 | NEHMERZYLINDER | 6Q0 721 261 F, 6Q0 721 261 D, 6QE 721 261, 5Q0 721 261, 1U0 721 261 A, 6Q0 721 261 A | |



| | | | | | | | |
|--|----------|--|--|--|--------------------|---|--|
| | i | | | | Bezeichnung | OE-Nummern zu ATE Artikelnummern | i z.B. Vorsachnummern / diverse |
|--|----------|--|--|--|--------------------|---|--|

AUDI

| | | | | | | | | |
|---------------------------|------------------|----------|---------|---------|----------------|--------|----------------|--|
| A3 / A3 Sportback (03-13) | 1,4 TFSI | 3) Coull | 07.2007 | 08.2013 | 24.2519-1706.3 | 040096 | NEHMERZYLINDER | 6Q0 721 261 F, 6Q0 721 261 D, 6QE 721 261, 5Q0 721 261, 1U0 721 261 A, 6Q0 721 261 A |
| | 1,6 | 3) Coull | 05.2003 | 08.2013 | 24.2519-1706.3 | 040096 | NEHMERZYLINDER | 6Q0 721 261 F, 6Q0 721 261 D, 6QE 721 261, 5Q0 721 261, 1U0 721 261 A, 6Q0 721 261 A |
| | 1,6 FSI | 3) Coull | 08.2003 | 08.2013 | 24.2519-1706.3 | 040096 | NEHMERZYLINDER | 6Q0 721 261 F, 6Q0 721 261 D, 6QE 721 261, 5Q0 721 261, 1U0 721 261 A, 6Q0 721 261 A |
| | 1,6 TDI | 3) Coull | 05.2009 | 08.2013 | 24.2519-1706.3 | 040096 | NEHMERZYLINDER | 6Q0 721 261 F, 6Q0 721 261 D, 6QE 721 261, 5Q0 721 261, 1U0 721 261 A, 6Q0 721 261 A |
| | 1,8 TFSI | 3) Coull | 01.2007 | 08.2013 | 24.2519-1706.3 | 040096 | NEHMERZYLINDER | 6Q0 721 261 F, 6Q0 721 261 D, 6QE 721 261, 5Q0 721 261, 1U0 721 261 A, 6Q0 721 261 A |
| | 1,8 TFSI quattro | 3) Coull | 05.2008 | 08.2013 | 24.2519-1706.3 | 040096 | NEHMERZYLINDER | 6Q0 721 261 F, 6Q0 721 261 D, 6QE 721 261, 5Q0 721 261, 1U0 721 261 A, 6Q0 721 261 A |
| | 1,9 TDI | 3) Coull | 06.2003 | 08.2013 | 24.2519-1706.3 | 040096 | NEHMERZYLINDER | 6Q0 721 261 F, 6Q0 721 261 D, 6QE 721 261, 5Q0 721 261, 1U0 721 261 A, 6Q0 721 261 A |
| | 2,0 FSI | 3) Coull | 05.2003 | 08.2013 | 24.2519-1706.3 | 040096 | NEHMERZYLINDER | 6Q0 721 261 F, 6Q0 721 261 D, 6QE 721 261, 5Q0 721 261, 1U0 721 261 A, 6Q0 721 261 A |
| | 2,0 TDI | 3) Coull | 06.2006 | 06.2008 | 24.2519-1706.3 | 040096 | NEHMERZYLINDER | 6Q0 721 261 F, 6Q0 721 261 D, 6QE 721 261, 5Q0 721 261, 1U0 721 261 A, 6Q0 721 261 A |



| | | | | | | | |
|--|----------|--|--|--|--------------------|---|--|
| | i | | | | Bezeichnung | OE-Nummern zu ATE Artikelnummern | i z.B. Vorsachnummern / diverse |
|--|----------|--|--|--|--------------------|---|--|

AUDI

| | | | | | | | | |
|---------------------------|------------------|----------|---------|---------|----------------|--------|----------------|---|
| A3 / A3 Sportback (03-13) | 2,0 TDI | 3) Coull | 03.2006 | 08.2013 | 24.2519-1706.3 | 040096 | NEHMERZYLINDER | 6Q0 721 261 F , 6Q0 721 261 D , 6QE 721 261 , 5Q0 721 261 , 1U0 721 261 A , 6Q0 721 261 A |
| | | 3) Coull | 05.2003 | 08.2013 | 24.2519-1706.3 | 040096 | NEHMERZYLINDER | 6Q0 721 261 F , 6Q0 721 261 D , 6QE 721 261 , 5Q0 721 261 , 1U0 721 261 A , 6Q0 721 261 A |
| | 2,0 TDI quattro | 3) Coull | 03.2006 | 08.2013 | 24.2519-1706.3 | 040096 | NEHMERZYLINDER | 6Q0 721 261 F , 6Q0 721 261 D , 6QE 721 261 , 5Q0 721 261 , 1U0 721 261 A , 6Q0 721 261 A |
| | | 3) Coull | 05.2003 | 08.2013 | 24.2519-1706.3 | 040096 | NEHMERZYLINDER | 6Q0 721 261 F , 6Q0 721 261 D , 6QE 721 261 , 5Q0 721 261 , 1U0 721 261 A , 6Q0 721 261 A |
| | | 3) Coull | 08.2004 | 08.2013 | 24.2519-1706.3 | 040096 | NEHMERZYLINDER | 6Q0 721 261 F , 6Q0 721 261 D , 6QE 721 261 , 5Q0 721 261 , 1U0 721 261 A , 6Q0 721 261 A |
| | 2,0 TFSI | 3) Coull | 06.2004 | 08.2013 | 24.2519-1706.3 | 040096 | NEHMERZYLINDER | 6Q0 721 261 F , 6Q0 721 261 D , 6QE 721 261 , 5Q0 721 261 , 1U0 721 261 A , 6Q0 721 261 A |
| | 2,0 TFSI quattro | 3) Coull | 06.2004 | 08.2013 | 24.2519-1706.3 | 040096 | NEHMERZYLINDER | 6Q0 721 261 F , 6Q0 721 261 D , 6QE 721 261 , 5Q0 721 261 , 1U0 721 261 A , 6Q0 721 261 A |
| | 3,2 quattro | 3) Coull | 07.2003 | 08.2013 | 24.2519-1706.3 | 040096 | NEHMERZYLINDER | 6Q0 721 261 F , 6Q0 721 261 D , 6QE 721 261 , 5Q0 721 261 , 1U0 721 261 A , 6Q0 721 261 A |
| | S3 quattro | 3) Coull | 07.2008 | 08.2013 | 24.2519-1706.3 | 040096 | NEHMERZYLINDER | 6Q0 721 261 F , 6Q0 721 261 D , 6QE 721 261 , 5Q0 721 261 , 1U0 721 261 A , 6Q0 721 261 A |



| | | | | | | | |
|--|----------|--|--|--|--------------------|---|--|
| | i | | | | Bezeichnung | OE-Nummern zu ATE Artikelnummern | i z.B. Vorsachnummern / diverse |
|--|----------|--|--|--|--------------------|---|--|

AUDI

| | | | | | | | | |
|---------------------------|-----------------|----------|---------|---------|----------------|--------|----------------|--|
| A3 / A3 Sportback (03-13) | S3 quattro | 3) Coull | 11.2006 | 08.2013 | 24.2519-1706.3 | 040096 | NEHMERZYLINDER | 6Q0 721 261 F, 6Q0 721 261 D, 6QE 721 261, 5Q0 721 261, 1U0 721 261 A, 6Q0 721 261 A |
| A3 / A3 Sportback (12-) | 1,2 TFSI | 3) Coull | 02.2013 | | 24.2519-1706.3 | 040096 | NEHMERZYLINDER | 6Q0 721 261 F, 6Q0 721 261 D, 6QE 721 261, 5Q0 721 261, 1U0 721 261 A, 6Q0 721 261 A |
| | 1,4 TFSI | 3) Coull | 08.2012 | | 24.2519-1706.3 | 040096 | NEHMERZYLINDER | 6Q0 721 261 F, 6Q0 721 261 D, 6QE 721 261, 5Q0 721 261, 1U0 721 261 A, 6Q0 721 261 A |
| | | 3) Coull | 10.2012 | | 24.2519-1706.3 | 040096 | NEHMERZYLINDER | 6Q0 721 261 F, 6Q0 721 261 D, 6QE 721 261, 5Q0 721 261, 1U0 721 261 A, 6Q0 721 261 A |
| | | 3) Coull | 09.2013 | | 24.2519-1706.3 | 040096 | NEHMERZYLINDER | 6Q0 721 261 F, 6Q0 721 261 D, 6QE 721 261, 5Q0 721 261, 1U0 721 261 A, 6Q0 721 261 A |
| | 1,4 TFSI e-tron | 3) Coull | 02.2014 | | 24.2519-1706.3 | 040096 | NEHMERZYLINDER | 6Q0 721 261 F, 6Q0 721 261 D, 6QE 721 261, 5Q0 721 261, 1U0 721 261 A, 6Q0 721 261 A |
| | 1,4 TFSI g-tron | 3) Coull | 02.2014 | | 24.2519-1706.3 | 040096 | NEHMERZYLINDER | 6Q0 721 261 F, 6Q0 721 261 D, 6QE 721 261, 5Q0 721 261, 1U0 721 261 A, 6Q0 721 261 A |
| | 1,6 TDI | 3) Coull | 09.2012 | | 24.2519-1706.3 | 040096 | NEHMERZYLINDER | 6Q0 721 261 F, 6Q0 721 261 D, 6QE 721 261, 5Q0 721 261, 1U0 721 261 A, 6Q0 721 261 A |
| | 1,6 TDI ultra | 3) Coull | 08.2013 | | 24.2519-1706.3 | 040096 | NEHMERZYLINDER | 6Q0 721 261 F, 6Q0 721 261 D, 6QE 721 261, 5Q0 721 261, 1U0 721 261 A, 6Q0 721 261 A |



| | | | | | | | |
|--|----------|--|--|--|--------------------|---|--|
| | i | | | | Bezeichnung | OE-Nummern zu ATE Artikelnummern | i z.B. Vorsachnummern / diverse |
|--|----------|--|--|--|--------------------|---|--|

AUDI

| | | | | | | | | |
|-------------------------|------------------|----------|---------|--|----------------|--------|----------------|---|
| A3 / A3 Sportback (12-) | 1,8 TFSI | 3) Coull | 08.2012 | | 24.2519-1706.3 | 040096 | NEHMERZYLINDER | 6Q0 721 261 F , 6Q0 721 261 D , 6QE 721 261 , 5Q0 721 261 , 1U0 721 261 A , 6Q0 721 261 A |
| | 1,8 TFSI quattro | 3) Coull | 08.2012 | | 24.2519-1706.3 | 040096 | NEHMERZYLINDER | 6Q0 721 261 F , 6Q0 721 261 D , 6QE 721 261 , 5Q0 721 261 , 1U0 721 261 A , 6Q0 721 261 A |
| | 2,0 TDI | 3) Coull | 12.2012 | | 24.2519-1706.3 | 040096 | NEHMERZYLINDER | 6Q0 721 261 F , 6Q0 721 261 D , 6QE 721 261 , 5Q0 721 261 , 1U0 721 261 A , 6Q0 721 261 A |
| | | 3) Coull | 01.2013 | | 24.2519-1706.3 | 040096 | NEHMERZYLINDER | 6Q0 721 261 F , 6Q0 721 261 D , 6QE 721 261 , 5Q0 721 261 , 1U0 721 261 A , 6Q0 721 261 A |
| | | 3) Coull | 08.2012 | | 24.2519-1706.3 | 040096 | NEHMERZYLINDER | 6Q0 721 261 F , 6Q0 721 261 D , 6QE 721 261 , 5Q0 721 261 , 1U0 721 261 A , 6Q0 721 261 A |
| | | 3) Coull | 05.2013 | | 24.2519-1706.3 | 040096 | NEHMERZYLINDER | 6Q0 721 261 F , 6Q0 721 261 D , 6QE 721 261 , 5Q0 721 261 , 1U0 721 261 A , 6Q0 721 261 A |
| | 2,0 TDI quattro | 3) Coull | 12.2012 | | 24.2519-1706.3 | 040096 | NEHMERZYLINDER | 6Q0 721 261 F , 6Q0 721 261 D , 6QE 721 261 , 5Q0 721 261 , 1U0 721 261 A , 6Q0 721 261 A |
| | | 3) Coull | 10.2012 | | 24.2519-1706.3 | 040096 | NEHMERZYLINDER | 6Q0 721 261 F , 6Q0 721 261 D , 6QE 721 261 , 5Q0 721 261 , 1U0 721 261 A , 6Q0 721 261 A |
| | S3 | 3) Coull | 10.2012 | | 24.2519-1706.3 | 040096 | NEHMERZYLINDER | 6Q0 721 261 F , 6Q0 721 261 D , 6QE 721 261 , 5Q0 721 261 , 1U0 721 261 A , 6Q0 721 261 A |



| | | | | | | | |
|---|----------|---|--|---|--------------------|---|--|
|  | i |  |  |  | Bezeichnung | OE-Nummern zu ATE Artikelnummern | i z.B. Vorsachnummern / diverse |
|---|----------|---|--|---|--------------------|---|--|

AUDI

| | | | | | | | | |
|-------------------------|----------|----------|---------|---------|----------------|--------|----------------|--|
| A3 / A3 Sportback (12-) | S3 | 3) Coull | 02.2013 | | 24.2519-1706.3 | 040096 | NEHMERZYLINDER | 6Q0 721 261 F, 6Q0 721 261 D, 6QE 721 261, 5Q0 721 261, 1U0 721 261 A, 6Q0 721 261 A |
| A3 Cabrio (08-13) | 1,2 TSI | 3) Coull | 03.2010 | 08.2013 | 24.2519-1706.3 | 040096 | NEHMERZYLINDER | 6Q0 721 261 F, 6Q0 721 261 D, 6QE 721 261, 5Q0 721 261, 1U0 721 261 A, 6Q0 721 261 A |
| | 1,4 TFSI | 3) Coull | 01.2011 | 08.2013 | 24.2519-1706.3 | 040096 | NEHMERZYLINDER | 6Q0 721 261 F, 6Q0 721 261 D, 6QE 721 261, 5Q0 721 261, 1U0 721 261 A, 6Q0 721 261 A |
| | 1,6 | 3) Coull | 09.2008 | 08.2013 | 24.2519-1706.3 | 040096 | NEHMERZYLINDER | 6Q0 721 261 F, 6Q0 721 261 D, 6QE 721 261, 5Q0 721 261, 1U0 721 261 A, 6Q0 721 261 A |
| | 1,6 TDI | 3) Coull | 05.2009 | 08.2013 | 24.2519-1706.3 | 040096 | NEHMERZYLINDER | 6Q0 721 261 F, 6Q0 721 261 D, 6QE 721 261, 5Q0 721 261, 1U0 721 261 A, 6Q0 721 261 A |
| | 1,8 TFSI | 3) Coull | 04.2008 | 08.2013 | 24.2519-1706.3 | 040096 | NEHMERZYLINDER | 6Q0 721 261 F, 6Q0 721 261 D, 6QE 721 261, 5Q0 721 261, 1U0 721 261 A, 6Q0 721 261 A |
| | 1,9 TDI | 3) Coull | 04.2008 | 08.2013 | 24.2519-1706.3 | 040096 | NEHMERZYLINDER | 6Q0 721 261 F, 6Q0 721 261 D, 6QE 721 261, 5Q0 721 261, 1U0 721 261 A, 6Q0 721 261 A |
| | 2,0 TDI | 3) Coull | 04.2008 | 08.2013 | 24.2519-1706.3 | 040096 | NEHMERZYLINDER | 6Q0 721 261 F, 6Q0 721 261 D, 6QE 721 261, 5Q0 721 261, 1U0 721 261 A, 6Q0 721 261 A |
| | 2,0 TFSI | 3) Coull | 04.2008 | 08.2013 | 24.2519-1706.3 | 040096 | NEHMERZYLINDER | 6Q0 721 261 F, 6Q0 721 261 D, 6QE 721 261, 5Q0 721 261, 1U0 721 261 A, 6Q0 721 261 A |



| | | | | | | | |
|--|----------|--|--|--|--------------------|---|--|
| | i | | | | Bezeichnung | OE-Nummern zu ATE Artikelnummern | i z.B. Vorsachnummern / diverse |
|--|----------|--|--|--|--------------------|---|--|

AUDI

| | | | | | | | | |
|---------------------|------------------|----------|---------|--|----------------|--------|----------------------|---|
| A3 Cabrio (13-) | 1,4 TFSI | 3) Coull | 10.2013 | | 24.2519-1706.3 | 040096 | NEHMERZYLINDER | 6Q0 721 261 F , 6Q0 721 261 D , 6QE 721 261 , 5Q0 721 261 , 1U0 721 261 A , 6Q0 721 261 A |
| | 1,6 TDI | 3) Coull | 10.2013 | | 24.2519-1706.3 | 040096 | NEHMERZYLINDER | 6Q0 721 261 F , 6Q0 721 261 D , 6QE 721 261 , 5Q0 721 261 , 1U0 721 261 A , 6Q0 721 261 A |
| | 1,8 TFSI | 3) Coull | 10.2013 | | 24.2519-1706.3 | 040096 | NEHMERZYLINDER | 6Q0 721 261 F , 6Q0 721 261 D , 6QE 721 261 , 5Q0 721 261 , 1U0 721 261 A , 6Q0 721 261 A |
| | 1,8 TFSI quattro | 3) Coull | 03.2014 | | 24.2519-1706.3 | 040096 | NEHMERZYLINDER | 6Q0 721 261 F , 6Q0 721 261 D , 6QE 721 261 , 5Q0 721 261 , 1U0 721 261 A , 6Q0 721 261 A |
| | 2,0 TDI | 3) Coull | 10.2013 | | 24.2519-1706.3 | 040096 | NEHMERZYLINDER | 6Q0 721 261 F , 6Q0 721 261 D , 6QE 721 261 , 5Q0 721 261 , 1U0 721 261 A , 6Q0 721 261 A |
| | 2,0 TDI quattro | 3) Coull | 03.2014 | | 24.2519-1706.3 | 040096 | NEHMERZYLINDER | 6Q0 721 261 F , 6Q0 721 261 D , 6QE 721 261 , 5Q0 721 261 , 1U0 721 261 A , 6Q0 721 261 A |
| | S3 | 3) Coull | 04.2014 | | 24.2519-1706.3 | 040096 | NEHMERZYLINDER | 6Q0 721 261 F , 6Q0 721 261 D , 6QE 721 261 , 5Q0 721 261 , 1U0 721 261 A , 6Q0 721 261 A |
| A4 (B8) Avant (08-) | 1,8 FSI | 3) Coull | 04.2008 | | 03.2125-0493.3 | 010940 | TANDEM-HAUPTZYLINDER | 8R0 611 021 , 8K0 611 021 A |
| | 1,8 TFSI | 3) Coull | 04.2008 | | 03.2125-0493.3 | 010940 | TANDEM-HAUPTZYLINDER | 8R0 611 021 , 8K0 611 021 A |
| | 1,8 TFSI quattro | 3) Coull | 09.2008 | | 03.2125-0493.3 | 010940 | TANDEM-HAUPTZYLINDER | 8R0 611 021 , 8K0 611 021 A |
| | 2,0 TDI | 3) Coull | 06.2008 | | 03.2125-0493.3 | 010940 | TANDEM-HAUPTZYLINDER | 8R0 611 021 , 8K0 611 021 A |
| | | 3) Coull | 04.2008 | | 03.2125-0493.3 | 010940 | TANDEM-HAUPTZYLINDER | 8R0 611 021 , 8K0 611 021 A |



| | | | | | | | |
|--|--|--|--|--|--------------------|---|--------------------------------------|
| | | | | | Bezeichnung | OE-Nummern zu ATE Artikelnummern | z.B. Vorsachnummern / diverse |
|--|--|--|--|--|--------------------|---|--------------------------------------|

AUDI

| | | | | | | | | |
|-------------------------|------------------|---------|---------|--|----------------|--------|----------------------|-----------------------------|
| A4 (B8) Avant (08-) | 2,0 TDI quattro | 3) Coup | 08.2008 | | 03.2125-0493.3 | 010940 | TANDEM-HAUPTZYLINDER | 8R0 611 021 , 8K0 611 021 A |
| | | 3) Coup | 04.2008 | | 03.2125-0493.3 | 010940 | TANDEM-HAUPTZYLINDER | 8R0 611 021 , 8K0 611 021 A |
| | 2,0 TFSI | 3) Coup | 06.2008 | | 03.2125-0493.3 | 010940 | TANDEM-HAUPTZYLINDER | 8R0 611 021 , 8K0 611 021 A |
| | | 3) Coup | 04.2008 | | 03.2125-0493.3 | 010940 | TANDEM-HAUPTZYLINDER | 8R0 611 021 , 8K0 611 021 A |
| | 2,0 TFSI quattro | 3) Coup | 04.2008 | | 03.2125-0493.3 | 010940 | TANDEM-HAUPTZYLINDER | 8R0 611 021 , 8K0 611 021 A |
| | | 3) Coup | 11.2009 | | 03.2125-0493.3 | 010940 | TANDEM-HAUPTZYLINDER | 8R0 611 021 , 8K0 611 021 A |
| | 2,7 TDI | 3) Coup | 06.2008 | | 03.2125-0493.3 | 010940 | TANDEM-HAUPTZYLINDER | 8R0 611 021 , 8K0 611 021 A |
| | 3,0 TDI quattro | 3) Coup | 06.2008 | | 03.2125-0493.3 | 010940 | TANDEM-HAUPTZYLINDER | 8R0 611 021 , 8K0 611 021 A |
| | | 3) Coup | 04.2008 | | 03.2125-0493.3 | 010940 | TANDEM-HAUPTZYLINDER | 8R0 611 021 , 8K0 611 021 A |
| | 3,2 FSI | 3) Coup | 09.2008 | | 03.2125-0493.3 | 010940 | TANDEM-HAUPTZYLINDER | 8R0 611 021 , 8K0 611 021 A |
| | 3,2 FSI quattro | 3) Coup | 04.2008 | | 03.2125-0493.3 | 010940 | TANDEM-HAUPTZYLINDER | 8R0 611 021 , 8K0 611 021 A |
| | S4 | 3) Coup | 11.2008 | | 03.2125-0493.3 | 010940 | TANDEM-HAUPTZYLINDER | 8R0 611 021 , 8K0 611 021 A |
| A4 (B8) Limousine (07-) | 1,8 TFSI | 3) Coup | 11.2007 | | 03.2125-0493.3 | 010940 | TANDEM-HAUPTZYLINDER | 8R0 611 021 , 8K0 611 021 A |
| | | 3) Coup | 01.2008 | | 03.2125-0493.3 | 010940 | TANDEM-HAUPTZYLINDER | 8R0 611 021 , 8K0 611 021 A |
| | 1,8 TFSI quattro | 3) Coup | 09.2008 | | 03.2125-0493.3 | 010940 | TANDEM-HAUPTZYLINDER | 8R0 611 021 , 8K0 611 021 A |
| | 2,0 TDI | 3) Coup | 01.2008 | | 03.2125-0493.3 | 010940 | TANDEM-HAUPTZYLINDER | 8R0 611 021 , 8K0 611 021 A |
| | | 3) Coup | 06.2008 | | 03.2125-0493.3 | 010940 | TANDEM-HAUPTZYLINDER | 8R0 611 021 , 8K0 611 021 A |
| | | 3) Coup | 08.2008 | | 03.2125-0493.3 | 010940 | TANDEM-HAUPTZYLINDER | 8R0 611 021 , 8K0 611 021 A |
| | | 3) Coup | 11.2007 | | 03.2125-0493.3 | 010940 | TANDEM-HAUPTZYLINDER | 8R0 611 021 , 8K0 611 021 A |
| | 2,0 TDI quattro | 3) Coup | 01.2008 | | 03.2125-0493.3 | 010940 | TANDEM-HAUPTZYLINDER | 8R0 611 021 , 8K0 611 021 A |
| | 2,0 TFSI | 3) Coup | 06.2008 | | 03.2125-0493.3 | 010940 | TANDEM-HAUPTZYLINDER | 8R0 611 021 , 8K0 611 021 A |









| | | | | | | | |
|--|----------|--|--|--|--------------------|---|--|
| | i | | | | Bezeichnung | OE-Nummern zu ATE Artikelnummern | i z.B. Vorsachnummern / diverse |
|--|----------|--|--|--|--------------------|---|--|

AUDI

| | | | | | | | | | |
|-------------------------|--------------------|----------|---------|--|----------------|--------|----------------------|-----------------------------|--|
| A4 (B8) Limousine (07-) | 2,0 TFSI quattro | 3) Coupl | 06.2008 | | 03.2125-0493.3 | 010940 | TANDEM-HAUPTZYLINDER | 8R0 611 021 , 8K0 611 021 A | |
| | | 3) Coupl | 11.2009 | | 03.2125-0493.3 | 010940 | TANDEM-HAUPTZYLINDER | 8R0 611 021 , 8K0 611 021 A | |
| | 2,7 TDI | 3) Coupl | 11.2007 | | 03.2125-0493.3 | 010940 | TANDEM-HAUPTZYLINDER | 8R0 611 021 , 8K0 611 021 A | |
| | 3,0 TDI quattro | 3) Coupl | 11.2007 | | 03.2125-0493.3 | 010940 | TANDEM-HAUPTZYLINDER | 8R0 611 021 , 8K0 611 021 A | |
| | | 3) Coupl | 06.2008 | | 03.2125-0493.3 | 010940 | TANDEM-HAUPTZYLINDER | 8R0 611 021 , 8K0 611 021 A | |
| | 3,2 FSI | 3) Coupl | 09.2008 | | 03.2125-0493.3 | 010940 | TANDEM-HAUPTZYLINDER | 8R0 611 021 , 8K0 611 021 A | |
| | 3,2 FSI quattro | 3) Coupl | 11.2007 | | 03.2125-0493.3 | 010940 | TANDEM-HAUPTZYLINDER | 8R0 611 021 , 8K0 611 021 A | |
| | S4 | 3) Coupl | 11.2008 | | 03.2125-0493.3 | 010940 | TANDEM-HAUPTZYLINDER | 8R0 611 021 , 8K0 611 021 A | |
| A4 Allroad (09-) | 2,0 TDI quattro | 3) Coupl | 04.2009 | | 03.2125-0493.3 | 010940 | TANDEM-HAUPTZYLINDER | 8R0 611 021 , 8K0 611 021 A | |
| | | 3) Coupl | 01.2012 | | 03.2125-0493.3 | 010940 | TANDEM-HAUPTZYLINDER | 8R0 611 021 , 8K0 611 021 A | |
| | | 3) Coupl | 05.2013 | | 03.2125-0493.3 | 010940 | TANDEM-HAUPTZYLINDER | 8R0 611 021 , 8K0 611 021 A | |
| | | 3) Coupl | 09.2009 | | 03.2125-0493.3 | 010940 | TANDEM-HAUPTZYLINDER | 8R0 611 021 , 8K0 611 021 A | |
| | | 3) Coupl | 02.2009 | | 03.2125-0493.3 | 010940 | TANDEM-HAUPTZYLINDER | 8R0 611 021 , 8K0 611 021 A | |
| | 2,0 TDI quattro cd | 3) Coupl | 09.2013 | | 03.2125-0493.3 | 010940 | TANDEM-HAUPTZYLINDER | 8R0 611 021 , 8K0 611 021 A | |
| | 2,0 TFSI quattro | 3) Coupl | 05.2013 | | 03.2125-0493.3 | 010940 | TANDEM-HAUPTZYLINDER | 8R0 611 021 , 8K0 611 021 A | |
| | | 3) Coupl | 04.2009 | | 03.2125-0493.3 | 010940 | TANDEM-HAUPTZYLINDER | 8R0 611 021 , 8K0 611 021 A | |
| | | 3) Coupl | 04.2013 | | 03.2125-0493.3 | 010940 | TANDEM-HAUPTZYLINDER | 8R0 611 021 , 8K0 611 021 A | |
| | 3,0 TDI quattro | 3) Coupl | 04.2009 | | 03.2125-0493.3 | 010940 | TANDEM-HAUPTZYLINDER | 8R0 611 021 , 8K0 611 021 A | |
| | | 3) Coupl | 01.2012 | | 03.2125-0493.3 | 010940 | TANDEM-HAUPTZYLINDER | 8R0 611 021 , 8K0 611 021 A | |
| A5 / A5 Sportback (07-) | 1,8 TFSI | 3) Coupl | 10.2007 | | 03.2125-0493.3 | 010940 | TANDEM-HAUPTZYLINDER | 8R0 611 021 , 8K0 611 021 A | |
| | | 3) Coupl | 05.2009 | | 03.2125-0493.3 | 010940 | TANDEM-HAUPTZYLINDER | 8R0 611 021 , 8K0 611 021 A | |



| | | | | | | | |
|---|---|---|--|---|--------------------|---|---|
|  |  |  |  |  | Bezeichnung | OE-Nummern zu ATE Artikelnummern |  z.B. Vorsachnummern / diverse |
|---|---|---|--|---|--------------------|---|---|

AUDI

| | | | | | | | | | |
|-------------------------|------------------|----------|---------|--|----------------|--------|----------------------|-----------------------------|--|
| A5 / A5 Sportback (07-) | 2,0 TDI | 3) Coupl | 07.2011 | | 03.2125-0493.3 | 010940 | TANDEM-HAUPTZYLINDER | 8R0 611 021 , 8K0 611 021 A | |
| | | 3) Coupl | 08.2008 | | 03.2125-0493.3 | 010940 | TANDEM-HAUPTZYLINDER | 8R0 611 021 , 8K0 611 021 A | |
| | | 3) Coupl | 09.2009 | | 03.2125-0493.3 | 010940 | TANDEM-HAUPTZYLINDER | 8R0 611 021 , 8K0 611 021 A | |
| | | 3) Coupl | 10.2008 | | 03.2125-0493.3 | 010940 | TANDEM-HAUPTZYLINDER | 8R0 611 021 , 8K0 611 021 A | |
| | 2,0 TDI quattro | 3) Coupl | 08.2008 | | 03.2125-0493.3 | 010940 | TANDEM-HAUPTZYLINDER | 8R0 611 021 , 8K0 611 021 A | |
| | | 3) Coupl | 10.2008 | | 03.2125-0493.3 | 010940 | TANDEM-HAUPTZYLINDER | 8R0 611 021 , 8K0 611 021 A | |
| | 2,0 TFSI | 3) Coupl | 06.2008 | | 03.2125-0493.3 | 010940 | TANDEM-HAUPTZYLINDER | 8R0 611 021 , 8K0 611 021 A | |
| | | 3) Coupl | 11.2008 | | 03.2125-0493.3 | 010940 | TANDEM-HAUPTZYLINDER | 8R0 611 021 , 8K0 611 021 A | |
| | 2,0 TFSI quattro | 3) Coupl | 06.2008 | | 03.2125-0493.3 | 010940 | TANDEM-HAUPTZYLINDER | 8R0 611 021 , 8K0 611 021 A | |
| | 2,7 TDI | 3) Coupl | 05.2007 | | 03.2125-0493.3 | 010940 | TANDEM-HAUPTZYLINDER | 8R0 611 021 , 8K0 611 021 A | |
| | | 3) Coupl | 09.2007 | | 03.2125-0493.3 | 010940 | TANDEM-HAUPTZYLINDER | 8R0 611 021 , 8K0 611 021 A | |
| | 3,0 TDI | 3) Coupl | 07.2011 | | 03.2125-0493.3 | 010940 | TANDEM-HAUPTZYLINDER | 8R0 611 021 , 8K0 611 021 A | |
| | 3,0 TDI quattro | 3) Coupl | 07.2011 | | 03.2125-0493.3 | 010940 | TANDEM-HAUPTZYLINDER | 8R0 611 021 , 8K0 611 021 A | |
| | | 3) Coupl | 03.2008 | | 03.2125-0493.3 | 010940 | TANDEM-HAUPTZYLINDER | 8R0 611 021 , 8K0 611 021 A | |
| | | 3) Coupl | 05.2007 | | 03.2125-0493.3 | 010940 | TANDEM-HAUPTZYLINDER | 8R0 611 021 , 8K0 611 021 A | |
| | 3,2 FSI | 3) Coupl | 05.2007 | | 03.2125-0493.3 | 010940 | TANDEM-HAUPTZYLINDER | 8R0 611 021 , 8K0 611 021 A | |
| | 3,2 FSI quattro | 3) Coupl | 05.2007 | | 03.2125-0493.3 | 010940 | TANDEM-HAUPTZYLINDER | 8R0 611 021 , 8K0 611 021 A | |
| | S5 quattro | 3) Coupl | 05.2007 | | 03.2125-0493.3 | 010940 | TANDEM-HAUPTZYLINDER | 8R0 611 021 , 8K0 611 021 A | |
| | | 3) Coupl | 01.2010 | | 03.2125-0493.3 | 010940 | TANDEM-HAUPTZYLINDER | 8R0 611 021 , 8K0 611 021 A | |
| A5 Cabrio (09-) | 1,8 TFSI | 3) Coupl | 07.2011 | | 03.2125-0493.3 | 010940 | TANDEM-HAUPTZYLINDER | 8R0 611 021 , 8K0 611 021 A | |
| | | 3) Coupl | 09.2009 | | 03.2125-0493.3 | 010940 | TANDEM-HAUPTZYLINDER | 8R0 611 021 , 8K0 611 021 A | |



| | | | | | | | |
|--|--|--|--|--|--------------------|---|--------------------------------------|
| | | | | | Bezeichnung | OE-Nummern zu ATE Artikelnummern | z.B. Vorsachnummern / diverse |
|--|--|--|--|--|--------------------|---|--------------------------------------|

AUDI

| | | | | | | | | | |
|-----------------|------------------|----------|---------|--|----------------|--------|----------------------|-----------------------------|--|
| A5 Cabrio (09-) | 2,0 TDI | 3) Coupl | 07.2011 | | 03.2125-0493.3 | 010940 | TANDEM-HAUPTZYLINDER | 8R0 611 021 , 8K0 611 021 A | |
| | | 3) Coupl | 05.2009 | | 03.2125-0493.3 | 010940 | TANDEM-HAUPTZYLINDER | 8R0 611 021 , 8K0 611 021 A | |
| | 2,0 TFSI | 3) Coupl | 03.2009 | | 03.2125-0493.3 | 010940 | TANDEM-HAUPTZYLINDER | 8R0 611 021 , 8K0 611 021 A | |
| | 2,0 TFSI quattro | 3) Coupl | 03.2009 | | 03.2125-0493.3 | 010940 | TANDEM-HAUPTZYLINDER | 8R0 611 021 , 8K0 611 021 A | |
| | 2,7 TDI | 3) Coupl | 03.2009 | | 03.2125-0493.3 | 010940 | TANDEM-HAUPTZYLINDER | 8R0 611 021 , 8K0 611 021 A | |
| | | 3) Coupl | 05.2009 | | 03.2125-0493.3 | 010940 | TANDEM-HAUPTZYLINDER | 8R0 611 021 , 8K0 611 021 A | |
| | 3,0 TDI | 3) Coupl | 07.2011 | | 03.2125-0493.3 | 010940 | TANDEM-HAUPTZYLINDER | 8R0 611 021 , 8K0 611 021 A | |
| | 3,0 TDI quattro | 3) Coupl | 07.2011 | | 03.2125-0493.3 | 010940 | TANDEM-HAUPTZYLINDER | 8R0 611 021 , 8K0 611 021 A | |
| | | 3) Coupl | 03.2009 | | 03.2125-0493.3 | 010940 | TANDEM-HAUPTZYLINDER | 8R0 611 021 , 8K0 611 021 A | |
| | 3,2 FSI | 3) Coupl | 03.2009 | | 03.2125-0493.3 | 010940 | TANDEM-HAUPTZYLINDER | 8R0 611 021 , 8K0 611 021 A | |
| | 3,2 FSI quattro | 3) Coupl | 03.2009 | | 03.2125-0493.3 | 010940 | TANDEM-HAUPTZYLINDER | 8R0 611 021 , 8K0 611 021 A | |
| | S5 | 3) Coupl | 04.2009 | | 03.2125-0493.3 | 010940 | TANDEM-HAUPTZYLINDER | 8R0 611 021 , 8K0 611 021 A | |
| Q5 (08-) | 2,0 TDI | 3) Coupl | 08.2009 | | 03.2125-0493.3 | 010940 | TANDEM-HAUPTZYLINDER | 8R0 611 021 , 8K0 611 021 A | |
| | | 3) Coupl | 05.2013 | | 03.2125-0493.3 | 010940 | TANDEM-HAUPTZYLINDER | 8R0 611 021 , 8K0 611 021 A | |
| | 2,0 TDI quattro | 3) Coupl | 03.2009 | | 03.2125-0493.3 | 010940 | TANDEM-HAUPTZYLINDER | 8R0 611 021 , 8K0 611 021 A | |
| | | 3) Coupl | 09.2012 | | 03.2125-0493.3 | 010940 | TANDEM-HAUPTZYLINDER | 8R0 611 021 , 8K0 611 021 A | |
| | | 3) Coupl | 08.2009 | | 03.2125-0493.3 | 010940 | TANDEM-HAUPTZYLINDER | 8R0 611 021 , 8K0 611 021 A | |
| | | 3) Coupl | 05.2013 | | 03.2125-0493.3 | 010940 | TANDEM-HAUPTZYLINDER | 8R0 611 021 , 8K0 611 021 A | |
| | 2,0 TFSI quattro | 3) Coupl | 09.2012 | | 03.2125-0493.3 | 010940 | TANDEM-HAUPTZYLINDER | 8R0 611 021 , 8K0 611 021 A | |
| | | 3) Coupl | 08.2009 | | 03.2125-0493.3 | 010940 | TANDEM-HAUPTZYLINDER | 8R0 611 021 , 8K0 611 021 A | |
| | | 3) Coupl | 05.2013 | | 03.2125-0493.3 | 010940 | TANDEM-HAUPTZYLINDER | 8R0 611 021 , 8K0 611 021 A | |



| | | | | | | | |
|--|--|--|--|--|--------------------|---|--------------------------------------|
| | | | | | Bezeichnung | OE-Nummern zu ATE Artikelnummern | z.B. Vorsachnummern / diverse |
|--|--|--|--|--|--------------------|---|--------------------------------------|

AUDI

| | | | | | | | | | |
|----------|--------------------|----------|---------|--|----------------|--------|----------------------|-----------------------------|--|
| Q5 (08-) | 2,0 TFSI quattro | 3) Coupl | 03.2009 | | 03.2125-0493.3 | 010940 | TANDEM-HAUPTZYLINDER | 8R0 611 021 , 8K0 611 021 A | |
| | 3,0 TDI quattro | 3) Coupl | 09.2012 | | 03.2125-0493.3 | 010940 | TANDEM-HAUPTZYLINDER | 8R0 611 021 , 8K0 611 021 A | |
| | | 3) Coupl | 03.2009 | | 03.2125-0493.3 | 010940 | TANDEM-HAUPTZYLINDER | 8R0 611 021 , 8K0 611 021 A | |
| | 3,0 TFSI quattro | 3) Coupl | 09.2012 | | 03.2125-0493.3 | 010940 | TANDEM-HAUPTZYLINDER | 8R0 611 021 , 8K0 611 021 A | |
| | 3,2 FSI quattro | 3) Coupl | 03.2009 | | 03.2125-0493.3 | 010940 | TANDEM-HAUPTZYLINDER | 8R0 611 021 , 8K0 611 021 A | |
| | S 3,0 TDI quattro | 3) Coupl | 12.2012 | | 03.2125-0493.3 | 010940 | TANDEM-HAUPTZYLINDER | 8R0 611 021 , 8K0 611 021 A | |
| | S 3,0 TFSI quattro | 3) Coupl | 05.2013 | | 03.2125-0493.3 | 010940 | TANDEM-HAUPTZYLINDER | 8R0 611 021 , 8K0 611 021 A | |

CHEVROLET

| | | | | | | | | | |
|-------------------|---------|----------|---------|--|----------------|--------|-------------|----------|--|
| AVEO (T300) (11-) | 1,2 16V | 3) Coupl | 03.2011 | | 24.3220-1742.3 | 020549 | RADZYLINDER | 13304907 | |
| | 1,2 LPG | 3) Coupl | 11.2012 | | 24.3220-1742.3 | 020549 | RADZYLINDER | 13304907 | |
| | 1,3 D | 3) Coupl | 07.2011 | | 24.3220-1742.3 | 020549 | RADZYLINDER | 13304907 | |
| | 1,4 16V | 3) Coupl | 03.2011 | | 24.3220-1742.3 | 020549 | RADZYLINDER | 13304907 | |
| | | 3) Coupl | 12.2012 | | 24.3220-1742.3 | 020549 | RADZYLINDER | 13304907 | |
| | 1,6 16V | 3) Coupl | 03.2011 | | 24.3220-1742.3 | 020549 | RADZYLINDER | 13304907 | |
| | | 3) Coupl | 06.2011 | | 24.3220-1742.3 | 020549 | RADZYLINDER | 13304907 | |
| | | 3) Coupl | 12.2012 | | 24.3220-1742.3 | 020549 | RADZYLINDER | 13304907 | |



| | | | | | | | |
|--|--|--|--|--|--------------------|---|--------------------------------------|
| | | | | | Bezeichnung | OE-Nummern zu ATE Artikelnummern | z.B. Vorsachnummern / diverse |
|--|--|--|--|--|--------------------|---|--------------------------------------|

CITROEN

| | | | | | | | | | |
|------------------------------|---------------------|----------|---------|---------|----------------|--------|-------------|-------------------|--|
| C3 II (09-) | 1,0 VTi 68 | 3) Coull | 10.2012 | | 24.3220-1741.3 | 020548 | RADZYLINDER | 4402 F8 | |
| | 1,1 | 3) Coull | 09.2009 | | 24.3220-1741.3 | 020548 | RADZYLINDER | 4402 F8 | |
| | 1,2 VTi 82 | 3) Coull | 10.2012 | | 24.3220-1741.3 | 020548 | RADZYLINDER | 4402 F8 | |
| | 1,4 | 3) Coull | 09.2009 | | 24.3220-1741.3 | 020548 | RADZYLINDER | 4402 F8 | |
| | 1,4 Flex | 3) Coull | 11.2009 | | 24.3220-1741.3 | 020548 | RADZYLINDER | 4402 F8 | |
| | 1,4 HDi 70 | 3) Coull | 11.2009 | | 24.3220-1741.3 | 020548 | RADZYLINDER | 4402 F8 | |
| | 1,6 HDi | 3) Coull | 11.2009 | | 24.3220-1741.3 | 020548 | RADZYLINDER | 4402 F8 | |
| | 1,6 HDi 90 | 3) Coull | 09.2009 | | 24.3220-1741.3 | 020548 | RADZYLINDER | 4402 F8 | |
| C4 I Coupe (04-10) | 2,0 16V | VR | | 07.2010 | 11.9571-9940.2 | 220924 | FAUSTSATTEL | 4400 W2 , 4400 X2 | |
| | 2,0 HDi | VR | | 07.2010 | 11.9571-9940.2 | 220924 | FAUSTSATTEL | 4400 W2 , 4400 X2 | |
| | 2,0 HDi 135 | VR | | 07.2010 | 11.9571-9940.2 | 220924 | FAUSTSATTEL | 4400 W2 , 4400 X2 | |
| C4 I Limousine (LC_) (04-10) | 2,0 16V | VR | | 09.2010 | 11.9571-9940.2 | 220924 | FAUSTSATTEL | 4400 W2 , 4400 X2 | |
| | 2,0 HDi | VR | | 09.2010 | 11.9571-9940.2 | 220924 | FAUSTSATTEL | 4400 W2 , 4400 X2 | |
| | 2,0 HDi 135 | VR | | 09.2010 | 11.9571-9940.2 | 220924 | FAUSTSATTEL | 4400 W2 , 4400 X2 | |
| DS3 (09-) | 1,2 VTi 82 | 3) Coull | 10.2012 | | 24.3220-1741.3 | 020548 | RADZYLINDER | 4402 F8 | |
| | 1,6 HDi 90 | 3) Coull | 11.2009 | | 24.3220-1741.3 | 020548 | RADZYLINDER | 4402 F8 | |
| DS3 Cabrio (13-) | 1,2 PureTech VTi 82 | 3) Coull | 03.2013 | | 24.3220-1741.3 | 020548 | RADZYLINDER | 4402 F8 | |
| | 1,6 e-HDi 90 | 3) Coull | 03.2013 | | 24.3220-1741.3 | 020548 | RADZYLINDER | 4402 F8 | |



| | | | | | | | |
|--|--|--|--|--|--------------------|---|--------------------------------------|
| | | | | | Bezeichnung | OE-Nummern zu ATE Artikelnummern | z.B. Vorsachnummern / diverse |
|--|--|--|--|--|--------------------|---|--------------------------------------|

Classic PKW

| | | | | | | | | | |
|--|-----------|----------|---------|--|----------------|--------|-------------|---|----------------|
| MERCEDES BENZ G-Klasse (W461) (90-) | G 350 CDI | 3) Coull | 04.2010 | | 24.3222-1732.3 | 020537 | RADZYLINDER | 011 420 00 18 , 011 420 01 18 , 009 420 11 18 , 008 420 24 18 , 008 420 44 18 | 03.3222-7502.3 |
| MERCEDES BENZ Transporter (BM 611) 407 D-410 D | 407 D | 3) Coull | 06.1981 | | 24.3222-1732.3 | 020537 | RADZYLINDER | 011 420 00 18 , 011 420 01 18 , 009 420 11 18 , 008 420 24 18 , 008 420 44 18 | 03.3222-7502.3 |
| | 408 D | 3) Coull | 10.1988 | | 24.3222-1732.3 | 020537 | RADZYLINDER | 011 420 00 18 , 011 420 01 18 , 009 420 11 18 , 008 420 24 18 , 008 420 44 18 | 03.3222-7502.3 |
| | 409 D | 3) Coull | 06.1981 | | 24.3222-1732.3 | 020537 | RADZYLINDER | 011 420 00 18 , 011 420 01 18 , 009 420 11 18 , 008 420 24 18 , 008 420 44 18 | 03.3222-7502.3 |
| | 410 | 3) Coull | 06.1981 | | 24.3222-1732.3 | 020537 | RADZYLINDER | 011 420 00 18 , 011 420 01 18 , 009 420 11 18 , 008 420 24 18 , 008 420 44 18 | 03.3222-7502.3 |
| | 410 D | 3) Coull | 11.1988 | | 24.3222-1732.3 | 020537 | RADZYLINDER | 011 420 00 18 , 011 420 01 18 , 009 420 11 18 , 008 420 24 18 , 008 420 44 18 | 03.3222-7502.3 |

FORD

| | | | | | | | | | |
|------------------|-----------|----------|---------|---------|----------------|--------|---------------|--|----------------|
| GALAXY I (95-06) | 1,9 TDI | 3) Coull | 10.1997 | 03.2000 | 24.5166-0454.3 | 331306 | BREMSSCHLAUCH | 1001348 , 95VW-2078-AE , 7335771 , 7M0 611 701 D | 83.7717-0450.3 |
| | | 3) Coull | 01.1996 | 04.2001 | 24.5166-0454.3 | 331306 | BREMSSCHLAUCH | 1001348 , 95VW-2078-AE , 7335771 , 7M0 611 701 D | 83.7717-0450.3 |
| | 2,0 i | 3) Coull | 09.1995 | 04.2001 | 24.5166-0454.3 | 331306 | BREMSSCHLAUCH | 1001348 , 95VW-2078-AE , 7335771 , 7M0 611 701 D | 83.7717-0450.3 |
| | 2,3 i 16V | 3) Coull | 01.1997 | 04.2001 | 24.5166-0454.3 | 331306 | BREMSSCHLAUCH | 1001348 , 95VW-2078-AE , 7335771 , 7M0 611 701 D | 83.7717-0450.3 |
| | 2,8 i V6 | 3) Coull | 09.1995 | 04.2001 | 24.5166-0454.3 | 331306 | BREMSSCHLAUCH | 1001348 , 95VW-2078-AE , 7335771 , 7M0 611 701 D | 83.7717-0450.3 |



Bezeichnung

OE-Nummern
zu ATE
Artikelnummern



z.B. Vorsachnummern /
diverse

HYUNDAI

| | | | | | | | | | |
|--------------------|--------------|----------|---------|---------|----------------|--------|--------------|---|---------|
| ACCENT IV (10-) | 1,4 16V | 3) Coull | 11.2010 | | 13.0460-5786.2 | 605786 | BELAGSATZ | 58302-2KA10 , 58302-1WA35 , 58302-3ZA10 , 58302-3ZA70 , 58302-2VA50 , 58302-3XA30 , 58302-1RA30 | s. Abb. |
| | 1,4 CRDi | 3) Coull | 11.2010 | | 13.0460-5786.2 | 605786 | BELAGSATZ | 58302-2KA10 , 58302-1WA35 , 58302-3ZA10 , 58302-3ZA70 , 58302-2VA50 , 58302-3XA30 , 58302-1RA30 | s. Abb. |
| | 1,6 16V | 3) Coull | 11.2010 | | 13.0460-5786.2 | 605786 | BELAGSATZ | 58302-2KA10 , 58302-1WA35 , 58302-3ZA10 , 58302-3ZA70 , 58302-2VA50 , 58302-3XA30 , 58302-1RA30 | s. Abb. |
| | 1,6 CRDi | 3) Coull | 10.2011 | | 13.0460-5786.2 | 605786 | BELAGSATZ | 58302-2KA10 , 58302-1WA35 , 58302-3ZA10 , 58302-3ZA70 , 58302-2VA50 , 58302-3XA30 , 58302-1RA30 | s. Abb. |
| ELANTRA (11-) | 1,6 16V | 3) Coull | 06.2011 | | 13.0460-5786.2 | 605786 | BELAGSATZ | 58302-2KA10 , 58302-1WA35 , 58302-3ZA10 , 58302-3ZA70 , 58302-2VA50 , 58302-3XA30 , 58302-1RA30 | s. Abb. |
| | 1,8 16V | 3) Coull | 06.2011 | | 13.0460-5786.2 | 605786 | BELAGSATZ | 58302-2KA10 , 58302-1WA35 , 58302-3ZA10 , 58302-3ZA70 , 58302-2VA50 , 58302-3XA30 , 58302-1RA30 | s. Abb. |
| | 1,8 16V Flex | 3) Coull | 02.2011 | | 13.0460-5786.2 | 605786 | BELAGSATZ | 58302-2KA10 , 58302-1WA35 , 58302-3ZA10 , 58302-3ZA70 , 58302-2VA50 , 58302-3XA30 , 58302-1RA30 | s. Abb. |
| H-1 KASTEN (00-07) | 2,4 | 3) Coull | 11.2001 | 04.2004 | 24.0120-0235.1 | 420235 | BREMSSCHEIBE | 58329-4A450 | |
| | 2,5 CRDi | 3) Coull | 07.2001 | 04.2004 | 24.0120-0235.1 | 420235 | BREMSSCHEIBE | 58329-4A450 | |
| | | 3) Coull | 08.2003 | 04.2004 | 24.0120-0235.1 | 420235 | BREMSSCHEIBE | 58329-4A450 | |
| | 2,6 CRDi | 3) Coull | 08.2005 | 12.2007 | 24.0120-0235.1 | 420235 | BREMSSCHEIBE | 58329-4A450 | |



Bezeichnung

OE-Nummern
zu ATE
Artikelnummern



z.B. Vorsachnummern /
diverse

HYUNDAI

| | | | | | | | | | |
|--------------------|----------|----------|---------|--|----------------|--------|--------------|---|---------|
| i40 (12-) | 1,6 16V | 3) Coull | 03.2012 | | 13.0460-5786.2 | 605786 | BELAGSATZ | 58302-2KA10, 58302-1WA35, 58302-3ZA10, 58302-3ZA70, 58302-2VA50, 58302-3XA30, 58302-1RA30 | s. Abb. |
| | 1,7 CRDi | 3) Coull | 03.2012 | | 13.0460-5786.2 | 605786 | BELAGSATZ | 58302-2KA10, 58302-1WA35, 58302-3ZA10, 58302-3ZA70, 58302-2VA50, 58302-3XA30, 58302-1RA30 | s. Abb. |
| | 2,0 16V | 3) Coull | 03.2012 | | 13.0460-5786.2 | 605786 | BELAGSATZ | 58302-2KA10, 58302-1WA35, 58302-3ZA10, 58302-3ZA70, 58302-2VA50, 58302-3XA30, 58302-1RA30 | s. Abb. |
| | 2,0 CVT | 3) Coull | 10.2012 | | 13.0460-5786.2 | 605786 | BELAGSATZ | 58302-2KA10, 58302-1WA35, 58302-3ZA10, 58302-3ZA70, 58302-2VA50, 58302-3XA30, 58302-1RA30 | s. Abb. |
| i40 CW Kombi (11-) | 1,6 16V | 3) Coull | 06.2011 | | 13.0460-5786.2 | 605786 | BELAGSATZ | 58302-2KA10, 58302-1WA35, 58302-3ZA10, 58302-3ZA70, 58302-2VA50, 58302-3XA30, 58302-1RA30 | s. Abb. |
| | 1,7 CRDi | 3) Coull | 06.2011 | | 13.0460-5786.2 | 605786 | BELAGSATZ | 58302-2KA10, 58302-1WA35, 58302-3ZA10, 58302-3ZA70, 58302-2VA50, 58302-3XA30, 58302-1RA30 | s. Abb. |
| | 2,0 16V | 3) Coull | 06.2011 | | 13.0460-5786.2 | 605786 | BELAGSATZ | 58302-2KA10, 58302-1WA35, 58302-3ZA10, 58302-3ZA70, 58302-2VA50, 58302-3XA30, 58302-1RA30 | s. Abb. |
| | 2,0 CVT | 3) Coull | 10.2012 | | 13.0460-5786.2 | 605786 | BELAGSATZ | 58302-2KA10, 58302-1WA35, 58302-3ZA10, 58302-3ZA70, 58302-2VA50, 58302-3XA30, 58302-1RA30 | s. Abb. |
| SONATA (05-) | 2,4 VVTi | 3) Coull | 06.2007 | | 24.0110-0367.1 | 410367 | BREMSSCHEIBE | 58411-3K110 | |
| | | 3) Coull | 06.2008 | | 24.0110-0367.1 | 410367 | BREMSSCHEIBE | 58411-3K110 | |



| | | | | | | | |
|--|----------|--|--|--|--------------------|---|--|
| | i | | | | Bezeichnung | OE-Nummern zu ATE Artikelnummern | i z.B. Vorsachnummern / diverse |
|--|----------|--|--|--|--------------------|---|--|

HYUNDAI

| | | | | | | | | | |
|----------------|-----------|---------|---------|--|----------------|--------|--------------|---|---------|
| SONATA (05-) | 3,3 VVTi | 3) Coup | 01.2008 | | 24.0110-0367.1 | 410367 | BREMSSCHEIBE | 58411-3K110 | |
| | | 3) Coup | 06.2007 | | 24.0110-0367.1 | 410367 | BREMSSCHEIBE | 58411-3K110 | |
| VELOSTER (11-) | 1,6 16V | 3) Coup | 10.2011 | | 13.0460-5786.2 | 605786 | BELAGSATZ | 58302-2KA10 , 58302-1WA35 , 58302-3ZA10 , 58302-3ZA70 , 58302-2VA50 , 58302-3XA30 , 58302-1RA30 | s. Abb. |
| | 1,6 GDI | 3) Coup | 03.2011 | | 13.0460-5786.2 | 605786 | BELAGSATZ | 58302-2KA10 , 58302-1WA35 , 58302-3ZA10 , 58302-3ZA70 , 58302-2VA50 , 58302-3XA30 , 58302-1RA30 | s. Abb. |
| | 1,6 T-GDI | 3) Coup | 10.2012 | | 13.0460-5786.2 | 605786 | BELAGSATZ | 58302-2KA10 , 58302-1WA35 , 58302-3ZA10 , 58302-3ZA70 , 58302-2VA50 , 58302-3XA30 , 58302-1RA30 | s. Abb. |



Bezeichnung

OE-Nummern
zu ATE
Artikelnummern



z.B. Vorsachnummern /
diverse

JAGUAR

| | | | | | | | | | |
|------------------------|---------------------|----------|---------|---------|----------------|--------|-----------------|--|--|
| S-Type (CCX) (99-08) | 2,5 V6 | 3) Coull | 02.2003 | 10.2007 | 03.0655-0007.2 | 370007 | DISTANCE SENSOR | 9G433311077 , 6804 6475AA , 9M68-2M113-AA , C2C 39935 , 163 540 12 17 , 30665607 | |
| | 2,7 D | 3) Coull | 06.2004 | 10.2007 | 03.0655-0007.2 | 370007 | DISTANCE SENSOR | 9G433311077 , 6804 6475AA , 9M68-2M113-AA , C2C 39935 , 163 540 12 17 , 30665607 | |
| | 3,0 V6 | 3) Coull | 05.2003 | 10.2007 | 03.0655-0007.2 | 370007 | DISTANCE SENSOR | 9G433311077 , 6804 6475AA , 9M68-2M113-AA , C2C 39935 , 163 540 12 17 , 30665607 | |
| | 4,2 V8 | 3) Coull | 02.2003 | 10.2007 | 03.0655-0007.2 | 370007 | DISTANCE SENSOR | 9G433311077 , 6804 6475AA , 9M68-2M113-AA , C2C 39935 , 163 540 12 17 , 30665607 | |
| | 4,2 V8 Supercharged | 3) Coull | 08.2003 | 12.2008 | 03.0655-0007.2 | 370007 | DISTANCE SENSOR | 9G433311077 , 6804 6475AA , 9M68-2M113-AA , C2C 39935 , 163 540 12 17 , 30665607 | |
| | R 4,2 V8 | 3) Coull | 08.2003 | 10.2007 | 03.0655-0007.2 | 370007 | DISTANCE SENSOR | 9G433311077 , 6804 6475AA , 9M68-2M113-AA , C2C 39935 , 163 540 12 17 , 30665607 | |
| XF (CC9) (08-) | 5,0 V8 Kompressor | 3) Coull | 01.2009 | | 24.0126-0174.1 | 426174 | BREMSSCHEIBE | C2P 13648 | |
| | | 3) Coull | 03.2009 | | 24.0126-0174.1 | 426174 | BREMSSCHEIBE | C2P 13648 | |
| | 5,0 XFR-S | 3) Coull | 10.2012 | | 24.0126-0174.1 | 426174 | BREMSSCHEIBE | C2P 13648 | |
| XJ (X350,X358) (03-09) | XJ6 3,0 | 3) Coull | 05.2003 | 03.2009 | 03.0655-0007.2 | 370007 | DISTANCE SENSOR | 9G433311077 , 6804 6475AA , 9M68-2M113-AA , C2C 39935 , 163 540 12 17 , 30665607 | |





| | | | | | | | |
|--|----------|--|--|--|--------------------|---|--|
| | i | | | | Bezeichnung | OE-Nummern zu ATE Artikelnummern | i z.B. Vorsachnummern / diverse |
|--|----------|--|--|--|--------------------|---|--|

JAGUAR

| | | | | | | | | | |
|-------------------------------|--------------------|---------|---------|---------|----------------|--------|-----------------|--|--|
| XJ (X350,X358) (03-09) | XJ6 3,0 | 3) Coup | 04.2004 | 01.2007 | 03.0655-0007.2 | 370007 | DISTANCE SENSOR | 9G433311077 , 6804 6475AA , 9M68-2M113-AA , C2C 39935 , 163 540 12 17 , 30665607 | |
| | XJ8 3,5 | 3) Coup | 05.2003 | 03.2009 | 03.0655-0007.2 | 370007 | DISTANCE SENSOR | 9G433311077 , 6804 6475AA , 9M68-2M113-AA , C2C 39935 , 163 540 12 17 , 30665607 | |
| | XJ8 4,2 | 3) Coup | 05.2003 | 03.2009 | 03.0655-0007.2 | 370007 | DISTANCE SENSOR | 9G433311077 , 6804 6475AA , 9M68-2M113-AA , C2C 39935 , 163 540 12 17 , 30665607 | |
| | XJR 4,2 Kompressor | 3) Coup | 05.2003 | 03.2009 | 03.0655-0007.2 | 370007 | DISTANCE SENSOR | 9G433311077 , 6804 6475AA , 9M68-2M113-AA , C2C 39935 , 163 540 12 17 , 30665607 | |
| XJ (X351) (09-) | 5,0 V8 | 3) Coup | 10.2009 | | 24.0126-0174.1 | 426174 | BREMSSCHEIBE | C2P 13648 | |
| | | 3) Coup | 06.2013 | | 24.0126-0174.1 | 426174 | BREMSSCHEIBE | C2P 13648 | |
| XK Convertible (06-) | 5,0 XKR | 3) Coup | 01.2009 | | 24.0126-0174.1 | 426174 | BREMSSCHEIBE | C2P 13648 | |
| | 5,0 XKR-S | 3) Coup | 01.2011 | | 24.0126-0174.1 | 426174 | BREMSSCHEIBE | C2P 13648 | |
| XK Coupe (06-) | 5,0 XKR | 3) Coup | 09.2010 | | 24.0126-0174.1 | 426174 | BREMSSCHEIBE | C2P 13648 | |
| | | 3) Coup | 01.2009 | | 24.0126-0174.1 | 426174 | BREMSSCHEIBE | C2P 13648 | |
| | 5,0 XKR-S | 3) Coup | 01.2011 | | 24.0126-0174.1 | 426174 | BREMSSCHEIBE | C2P 13648 | |
| XK8 Convertible (QDV) (96-05) | 4,2 V8 | 3) Coup | 08.2002 | 07.2005 | 03.0655-0007.2 | 370007 | DISTANCE SENSOR | 9G433311077 , 6804 6475AA , 9M68-2M113-AA , C2C 39935 , 163 540 12 17 , 30665607 | |
| | R 4,2 V8 | 3) Coup | 08.2002 | 07.2005 | 03.0655-0007.2 | 370007 | DISTANCE SENSOR | 9G433311077 , 6804 6475AA , 9M68-2M113-AA , C2C 39935 , 163 540 12 17 , 30665607 | |



| | | | | | | | |
|---|---|---|--|---|--------------------|---|---|
|  |  |  |  |  | Bezeichnung | OE-Nummern zu ATE Artikelnummern |  z.B. Vorsachnummern / diverse |
|---|---|---|--|---|--------------------|---|---|

JAGUAR

| | | | | | | | | | |
|-------------------------|----------|---------|---------|---------|----------------|--------|-----------------|--|--|
| XK8 Coupe (QEV) (96-05) | 4,2 V8 | 3) Coup | 08.2002 | 07.2005 | 03.0655-0007.2 | 370007 | DISTANCE SENSOR | 9G433311077 , 6804 6475AA , 9M68-2M113-AA , C2C 39935 , 163 540 12 17 , 30665607 | |
| | R 4,2 V8 | 3) Coup | 08.2002 | 07.2005 | 03.0655-0007.2 | 370007 | DISTANCE SENSOR | 9G433311077 , 6804 6475AA , 9M68-2M113-AA , C2C 39935 , 163 540 12 17 , 30665607 | |



| | | | | | | | |
|--|--|--|--|--|--------------------|---|--------------------------------------|
| | | | | | Bezeichnung | OE-Nummern zu ATE Artikelnummern | z.B. Vorsachnummern / diverse |
|--|--|--|--|--|--------------------|---|--------------------------------------|

KIA

| | | | | | | | | | |
|--------------------|-----------|----------|---------|--|----------------|--------|-----------|---|---------|
| OPTIMA (12-) | 1,7 CRDi | 3) Coull | 03.2012 | | 13.0460-5786.2 | 605786 | BELAGSATZ | 58302-2KA10, 58302-1WA35, 58302-3ZA10, 58302-3ZA70, 58302-2VA50, 58302-3XA30, 58302-1RA30 | s. Abb. |
| | 2,0 16V | 3) Coull | 03.2012 | | 13.0460-5786.2 | 605786 | BELAGSATZ | 58302-2KA10, 58302-1WA35, 58302-3ZA10, 58302-3ZA70, 58302-2VA50, 58302-3XA30, 58302-1RA30 | s. Abb. |
| | 2,0 CVVL | 3) Coull | 03.2012 | | 13.0460-5786.2 | 605786 | BELAGSATZ | 58302-2KA10, 58302-1WA35, 58302-3ZA10, 58302-3ZA70, 58302-2VA50, 58302-3XA30, 58302-1RA30 | s. Abb. |
| | 2,4 16V | 3) Coull | 03.2012 | | 13.0460-5786.2 | 605786 | BELAGSATZ | 58302-2KA10, 58302-1WA35, 58302-3ZA10, 58302-3ZA70, 58302-2VA50, 58302-3XA30, 58302-1RA30 | s. Abb. |
| RIO III (UB) (11-) | 1,1 CRDi | 3) Coull | 09.2011 | | 13.0460-5786.2 | 605786 | BELAGSATZ | 58302-2KA10, 58302-1WA35, 58302-3ZA10, 58302-3ZA70, 58302-2VA50, 58302-3XA30, 58302-1RA30 | s. Abb. |
| | 1,2 16V | 3) Coull | 09.2011 | | 13.0460-5786.2 | 605786 | BELAGSATZ | 58302-2KA10, 58302-1WA35, 58302-3ZA10, 58302-3ZA70, 58302-2VA50, 58302-3XA30, 58302-1RA30 | s. Abb. |
| | 1,25 CVVT | 3) Coull | 09.2011 | | 13.0460-5786.2 | 605786 | BELAGSATZ | 58302-2KA10, 58302-1WA35, 58302-3ZA10, 58302-3ZA70, 58302-2VA50, 58302-3XA30, 58302-1RA30 | s. Abb. |
| | 1,4 CRDi | 3) Coull | 09.2011 | | 13.0460-5786.2 | 605786 | BELAGSATZ | 58302-2KA10, 58302-1WA35, 58302-3ZA10, 58302-3ZA70, 58302-2VA50, 58302-3XA30, 58302-1RA30 | s. Abb. |
| | 1,4 CVVT | 3) Coull | 09.2011 | | 13.0460-5786.2 | 605786 | BELAGSATZ | 58302-2KA10, 58302-1WA35, 58302-3ZA10, 58302-3ZA70, 58302-2VA50, 58302-3XA30, 58302-1RA30 | s. Abb. |



| | | | | | | | |
|--|--|--|--|--|--------------------|---|--------------------------------------|
| | | | | | Bezeichnung | OE-Nummern zu ATE Artikelnummern | z.B. Vorsachnummern / diverse |
|--|--|--|--|--|--------------------|---|--------------------------------------|

KIA

| | | | | | | | | | |
|--------------------|--------------|----------|---------|--|----------------|--------|-----------|---|---------|
| RIO III (UB) (11-) | 1,6 CVT | 3) Coull | 06.2012 | | 13.0460-5786.2 | 605786 | BELAGSATZ | 58302-2KA10 , 58302-1WA35 , 58302-3ZA10 , 58302-3ZA70 , 58302-2VA50 , 58302-3XA30 , 58302-1RA30 | s. Abb. |
| SOUL (09-) | 1,6 CRDi 115 | 3) Coull | 02.2009 | | 13.0460-5786.2 | 605786 | BELAGSATZ | 58302-2KA10 , 58302-1WA35 , 58302-3ZA10 , 58302-3ZA70 , 58302-2VA50 , 58302-3XA30 , 58302-1RA30 | s. Abb. |
| | 1,6 CRDi 128 | 3) Coull | 02.2009 | | 13.0460-5786.2 | 605786 | BELAGSATZ | 58302-2KA10 , 58302-1WA35 , 58302-3ZA10 , 58302-3ZA70 , 58302-2VA50 , 58302-3XA30 , 58302-1RA30 | s. Abb. |
| | 1,6 CVT | 3) Coull | 02.2009 | | 13.0460-5786.2 | 605786 | BELAGSATZ | 58302-2KA10 , 58302-1WA35 , 58302-3ZA10 , 58302-3ZA70 , 58302-2VA50 , 58302-3XA30 , 58302-1RA30 | s. Abb. |
| | | 3) Coull | 03.2012 | | 13.0460-5786.2 | 605786 | BELAGSATZ | 58302-2KA10 , 58302-1WA35 , 58302-3ZA10 , 58302-3ZA70 , 58302-2VA50 , 58302-3XA30 , 58302-1RA30 | s. Abb. |
| | 1,6 Flex | 3) Coull | 01.2011 | | 13.0460-5786.2 | 605786 | BELAGSATZ | 58302-2KA10 , 58302-1WA35 , 58302-3ZA10 , 58302-3ZA70 , 58302-2VA50 , 58302-3XA30 , 58302-1RA30 | s. Abb. |
| | 1,6 GDI | 3) Coull | 06.2011 | | 13.0460-5786.2 | 605786 | BELAGSATZ | 58302-2KA10 , 58302-1WA35 , 58302-3ZA10 , 58302-3ZA70 , 58302-2VA50 , 58302-3XA30 , 58302-1RA30 | s. Abb. |



| | | | | | | | |
|--|--|--|--|--|--------------------|---|--------------------------------------|
| | | | | | Bezeichnung | OE-Nummern zu ATE Artikelnummern | z.B. Vorsachnummern / diverse |
|--|--|--|--|--|--------------------|---|--------------------------------------|

MERCEDES BENZ

| | | | | | | | | |
|-------------------------------------|----------------------|---------|---------|---------|----------------|--------|-----------------|--|
| C-Klasse (CL203) Sportcoupe (01-08) | C 160 Kompressor | 3) Coup | 04.2005 | 05.2008 | 03.0655-0007.2 | 370007 | DISTANCE SENSOR | 9G433311077 , 6804 6475AA , 9M68-2M113-AA , C2C 39935 , 163 540 12 17 , 30665607 |
| | C 180 | 3) Coup | 03.2001 | 05.2008 | 03.0655-0007.2 | 370007 | DISTANCE SENSOR | 9G433311077 , 6804 6475AA , 9M68-2M113-AA , C2C 39935 , 163 540 12 17 , 30665607 |
| | C 180 Kompressor | 3) Coup | 05.2002 | 05.2008 | 03.0655-0007.2 | 370007 | DISTANCE SENSOR | 9G433311077 , 6804 6475AA , 9M68-2M113-AA , C2C 39935 , 163 540 12 17 , 30665607 |
| | C 200 CDI | 3) Coup | 07.2003 | 05.2008 | 03.0655-0007.2 | 370007 | DISTANCE SENSOR | 9G433311077 , 6804 6475AA , 9M68-2M113-AA , C2C 39935 , 163 540 12 17 , 30665607 |
| | C 200 CGI Kompressor | 3) Coup | 07.2003 | 05.2008 | 03.0655-0007.2 | 370007 | DISTANCE SENSOR | 9G433311077 , 6804 6475AA , 9M68-2M113-AA , C2C 39935 , 163 540 12 17 , 30665607 |
| | C 200 Kompressor | 3) Coup | 03.2001 | 05.2008 | 03.0655-0007.2 | 370007 | DISTANCE SENSOR | 9G433311077 , 6804 6475AA , 9M68-2M113-AA , C2C 39935 , 163 540 12 17 , 30665607 |
| | C 220 CDI | 3) Coup | 03.2001 | 05.2008 | 03.0655-0007.2 | 370007 | DISTANCE SENSOR | 9G433311077 , 6804 6475AA , 9M68-2M113-AA , C2C 39935 , 163 540 12 17 , 30665607 |
| | C 230 | 3) Coup | 06.2005 | 05.2008 | 03.0655-0007.2 | 370007 | DISTANCE SENSOR | 9G433311077 , 6804 6475AA , 9M68-2M113-AA , C2C 39935 , 163 540 12 17 , 30665607 |
| | C 230 Kompressor | 3) Coup | 03.2001 | 05.2008 | 03.0655-0007.2 | 370007 | DISTANCE SENSOR | 9G433311077 , 6804 6475AA , 9M68-2M113-AA , C2C 39935 , 163 540 12 17 , 30665607 |



| | | | | | | | |
|--|----------|--|--|--|--------------------|---|--|
| | i | | | | Bezeichnung | OE-Nummern zu ATE Artikelnummern | i z.B. Vorsachnummern / diverse |
|--|----------|--|--|--|--------------------|---|--|

MERCEDES BENZ

| | | | | | | | | |
|-------------------------------------|--------------------|---------|---------|---------|----------------|--------|-----------------|--|
| C-Klasse (CL203) Sportcoupe (01-08) | C 30 CDI AMG | 3) Coup | 09.2002 | 05.2008 | 03.0655-0007.2 | 370007 | DISTANCE SENSOR | 9G433311077 , 6804 6475AA , 9M68-2M113-AA , C2C 39935 , 163 540 12 17 , 30665607 |
| | C 320 | 3) Coup | 09.2002 | 05.2008 | 03.0655-0007.2 | 370007 | DISTANCE SENSOR | 9G433311077 , 6804 6475AA , 9M68-2M113-AA , C2C 39935 , 163 540 12 17 , 30665607 |
| | C 350 | 3) Coup | 06.2005 | 05.2008 | 03.0655-0007.2 | 370007 | DISTANCE SENSOR | 9G433311077 , 6804 6475AA , 9M68-2M113-AA , C2C 39935 , 163 540 12 17 , 30665607 |
| C-Klasse (CLC203) Coupe (08-10) | CLC 160 | 3) Coup | 01.2009 | 10.2010 | 03.0655-0007.2 | 370007 | DISTANCE SENSOR | 9G433311077 , 6804 6475AA , 9M68-2M113-AA , C2C 39935 , 163 540 12 17 , 30665607 |
| | CLC 180 Kompressor | 3) Coup | 05.2008 | 10.2010 | 03.0655-0007.2 | 370007 | DISTANCE SENSOR | 9G433311077 , 6804 6475AA , 9M68-2M113-AA , C2C 39935 , 163 540 12 17 , 30665607 |
| | CLC 200 CDI | 3) Coup | 05.2008 | 10.2010 | 03.0655-0007.2 | 370007 | DISTANCE SENSOR | 9G433311077 , 6804 6475AA , 9M68-2M113-AA , C2C 39935 , 163 540 12 17 , 30665607 |
| | CLC 200 Kompressor | 3) Coup | 05.2008 | 10.2010 | 03.0655-0007.2 | 370007 | DISTANCE SENSOR | 9G433311077 , 6804 6475AA , 9M68-2M113-AA , C2C 39935 , 163 540 12 17 , 30665607 |
| | CLC 220 CDI | 3) Coup | 05.2008 | 10.2010 | 03.0655-0007.2 | 370007 | DISTANCE SENSOR | 9G433311077 , 6804 6475AA , 9M68-2M113-AA , C2C 39935 , 163 540 12 17 , 30665607 |
| | CLC 230 | 3) Coup | 05.2008 | 10.2010 | 03.0655-0007.2 | 370007 | DISTANCE SENSOR | 9G433311077 , 6804 6475AA , 9M68-2M113-AA , C2C 39935 , 163 540 12 17 , 30665607 |



Bezeichnung

OE-Nummern
zu ATE
Artikelnummern



z.B. Vorsachnummern /
diverse

MERCEDES BENZ

| C-Klasse (CLC203) Coupe (08-10) | CLC 350 | 3) Coup | 05.2008 | 10.2010 | 03.0655-0007.2 | 370007 | DISTANCE SENSOR | 9G433311077 , 6804 6475AA , 9M68-2M113-AA , C2C 39935 , 163 540 12 17 , 30665607 | |
|---------------------------------|----------------------|---------|---------|---------|----------------|--------|-----------------|--|--|
| C-Klasse (S203) Kombi (01-07) | C 180 | 3) Coup | 03.2001 | 09.2007 | 03.0655-0007.2 | 370007 | DISTANCE SENSOR | 9G433311077 , 6804 6475AA , 9M68-2M113-AA , C2C 39935 , 163 540 12 17 , 30665607 | |
| | C 180 Kompressor | 3) Coup | 05.2002 | 09.2007 | 03.0655-0007.2 | 370007 | DISTANCE SENSOR | 9G433311077 , 6804 6475AA , 9M68-2M113-AA , C2C 39935 , 163 540 12 17 , 30665607 | |
| | C 200 CDI | 3) Coup | 03.2001 | 09.2007 | 03.0655-0007.2 | 370007 | DISTANCE SENSOR | 9G433311077 , 6804 6475AA , 9M68-2M113-AA , C2C 39935 , 163 540 12 17 , 30665607 | |
| | | 3) Coup | 04.2003 | 09.2007 | 03.0655-0007.2 | 370007 | DISTANCE SENSOR | 9G433311077 , 6804 6475AA , 9M68-2M113-AA , C2C 39935 , 163 540 12 17 , 30665607 | |
| | C 200 CGI Kompressor | 3) Coup | 07.2003 | 09.2007 | 03.0655-0007.2 | 370007 | DISTANCE SENSOR | 9G433311077 , 6804 6475AA , 9M68-2M113-AA , C2C 39935 , 163 540 12 17 , 30665607 | |
| | C 200 Kompressor | 3) Coup | 05.2002 | 09.2007 | 03.0655-0007.2 | 370007 | DISTANCE SENSOR | 9G433311077 , 6804 6475AA , 9M68-2M113-AA , C2C 39935 , 163 540 12 17 , 30665607 | |
| | | 3) Coup | 03.2001 | 04.2002 | 03.0655-0007.2 | 370007 | DISTANCE SENSOR | 9G433311077 , 6804 6475AA , 9M68-2M113-AA , C2C 39935 , 163 540 12 17 , 30665607 | |
| | C 220 CDI | 3) Coup | 02.2004 | 09.2007 | 03.0655-0007.2 | 370007 | DISTANCE SENSOR | 9G433311077 , 6804 6475AA , 9M68-2M113-AA , C2C 39935 , 163 540 12 17 , 30665607 | |



| | | | | | | | |
|--|----------|--|--|--|--------------------|---|--|
| | i | | | | Bezeichnung | OE-Nummern zu ATE Artikelnummern | i z.B. Vorsachnummern / diverse |
|--|----------|--|--|--|--------------------|---|--|

MERCEDES BENZ

| | | | | | | | | | |
|-------------------------------|------------------|----------|---------|---------|----------------|--------|-----------------|--|--|
| C-Klasse (S203) Kombi (01-07) | C 220 CDI | 3) Coull | 03.2001 | 09.2007 | 03.0655-0007.2 | 370007 | DISTANCE SENSOR | 9G433311077 , 6804 6475AA , 9M68-2M113-AA , C2C 39935 , 163 540 12 17 , 30665607 | |
| | C 230 | 3) Coull | 06.2005 | 09.2007 | 03.0655-0007.2 | 370007 | DISTANCE SENSOR | 9G433311077 , 6804 6475AA , 9M68-2M113-AA , C2C 39935 , 163 540 12 17 , 30665607 | |
| | C 230 Kompressor | 3) Coull | 02.2004 | 09.2007 | 03.0655-0007.2 | 370007 | DISTANCE SENSOR | 9G433311077 , 6804 6475AA , 9M68-2M113-AA , C2C 39935 , 163 540 12 17 , 30665607 | |
| | C 240 | 3) Coull | 03.2001 | 09.2007 | 03.0655-0007.2 | 370007 | DISTANCE SENSOR | 9G433311077 , 6804 6475AA , 9M68-2M113-AA , C2C 39935 , 163 540 12 17 , 30665607 | |
| | C 240 4-matic | 3) Coull | 07.2002 | 09.2007 | 03.0655-0007.2 | 370007 | DISTANCE SENSOR | 9G433311077 , 6804 6475AA , 9M68-2M113-AA , C2C 39935 , 163 540 12 17 , 30665607 | |
| | C 270 CDI | 3) Coull | 03.2001 | 09.2007 | 03.0655-0007.2 | 370007 | DISTANCE SENSOR | 9G433311077 , 6804 6475AA , 9M68-2M113-AA , C2C 39935 , 163 540 12 17 , 30665607 | |
| | C 280 | 3) Coull | 06.2005 | 09.2007 | 03.0655-0007.2 | 370007 | DISTANCE SENSOR | 9G433311077 , 6804 6475AA , 9M68-2M113-AA , C2C 39935 , 163 540 12 17 , 30665607 | |
| | C 280 4-matic | 3) Coull | 06.2005 | 09.2007 | 03.0655-0007.2 | 370007 | DISTANCE SENSOR | 9G433311077 , 6804 6475AA , 9M68-2M113-AA , C2C 39935 , 163 540 12 17 , 30665607 | |
| | C 30 CDI AMG | 3) Coull | 01.2003 | 09.2007 | 03.0655-0007.2 | 370007 | DISTANCE SENSOR | 9G433311077 , 6804 6475AA , 9M68-2M113-AA , C2C 39935 , 163 540 12 17 , 30665607 | |



| | | | | | | | |
|--|--|--|--|--|--------------------|---|--------------------------------------|
| | | | | | Bezeichnung | OE-Nummern zu ATE Artikelnummern | z.B. Vorsachnummern / diverse |
|--|--|--|--|--|--------------------|---|--------------------------------------|

MERCEDES BENZ

| | | | | | | | | |
|-----------------------------------|---------------------|----------|---------|---------|----------------|--------|-----------------|--|
| C-Klasse (S203) Kombi (01-07) | C 32 Kompressor AMG | 3) Coull | 03.2001 | 09.2007 | 03.0655-0007.2 | 370007 | DISTANCE SENSOR | 9G433311077 , 6804 6475AA , 9M68-2M113-AA , C2C 39935 , 163 540 12 17 , 30665607 |
| | C 320 | 3) Coull | 03.2001 | 09.2007 | 03.0655-0007.2 | 370007 | DISTANCE SENSOR | 9G433311077 , 6804 6475AA , 9M68-2M113-AA , C2C 39935 , 163 540 12 17 , 30665607 |
| | C 320 4-matic | 3) Coull | 07.2002 | 09.2007 | 03.0655-0007.2 | 370007 | DISTANCE SENSOR | 9G433311077 , 6804 6475AA , 9M68-2M113-AA , C2C 39935 , 163 540 12 17 , 30665607 |
| | C 320 CDI | 3) Coull | 02.2005 | 09.2007 | 03.0655-0007.2 | 370007 | DISTANCE SENSOR | 9G433311077 , 6804 6475AA , 9M68-2M113-AA , C2C 39935 , 163 540 12 17 , 30665607 |
| | C 350 | 3) Coull | 06.2005 | 09.2007 | 03.0655-0007.2 | 370007 | DISTANCE SENSOR | 9G433311077 , 6804 6475AA , 9M68-2M113-AA , C2C 39935 , 163 540 12 17 , 30665607 |
| | C 350 4-matic | 3) Coull | 06.2005 | 09.2007 | 03.0655-0007.2 | 370007 | DISTANCE SENSOR | 9G433311077 , 6804 6475AA , 9M68-2M113-AA , C2C 39935 , 163 540 12 17 , 30665607 |
| | C 55 AMG | 3) Coull | 02.2004 | 09.2007 | 03.0655-0007.2 | 370007 | DISTANCE SENSOR | 9G433311077 , 6804 6475AA , 9M68-2M113-AA , C2C 39935 , 163 540 12 17 , 30665607 |
| C-Klasse (W203) Limousine (00-07) | C 180 | 3) Coull | 04.2000 | 04.2007 | 03.0655-0007.2 | 370007 | DISTANCE SENSOR | 9G433311077 , 6804 6475AA , 9M68-2M113-AA , C2C 39935 , 163 540 12 17 , 30665607 |
| | C 180 Kompressor | 3) Coull | 05.2002 | 04.2007 | 03.0655-0007.2 | 370007 | DISTANCE SENSOR | 9G433311077 , 6804 6475AA , 9M68-2M113-AA , C2C 39935 , 163 540 12 17 , 30665607 |



| | | | | | | | |
|--|--|--|--|--|--------------------|---|--------------------------------------|
| | | | | | Bezeichnung | OE-Nummern zu ATE Artikelnummern | z.B. Vorsachnummern / diverse |
|--|--|--|--|--|--------------------|---|--------------------------------------|

MERCEDES BENZ

| | | | | | | | | | |
|-----------------------------------|----------------------|----------|---------|---------|----------------|--------|-----------------|--|--|
| C-Klasse (W203) Limousine (00-07) | C 200 CDI | 3) Coull | 04.2000 | 04.2007 | 03.0655-0007.2 | 370007 | DISTANCE SENSOR | 9G433311077 , 6804 6475AA , 9M68-2M113-AA , C2C 39935 , 163 540 12 17 , 30665607 | |
| | | 3) Coull | 04.2003 | 04.2007 | 03.0655-0007.2 | 370007 | DISTANCE SENSOR | 9G433311077 , 6804 6475AA , 9M68-2M113-AA , C2C 39935 , 163 540 12 17 , 30665607 | |
| | C 200 CGI Kompressor | 3) Coull | 07.2003 | 04.2007 | 03.0655-0007.2 | 370007 | DISTANCE SENSOR | 9G433311077 , 6804 6475AA , 9M68-2M113-AA , C2C 39935 , 163 540 12 17 , 30665607 | |
| | C 200 Kompressor | 3) Coull | 04.2000 | 04.2007 | 03.0655-0007.2 | 370007 | DISTANCE SENSOR | 9G433311077 , 6804 6475AA , 9M68-2M113-AA , C2C 39935 , 163 540 12 17 , 30665607 | |
| | | 3) Coull | 05.2000 | 05.2002 | 03.0655-0007.2 | 370007 | DISTANCE SENSOR | 9G433311077 , 6804 6475AA , 9M68-2M113-AA , C2C 39935 , 163 540 12 17 , 30665607 | |
| | C 220 CDI | 3) Coull | 02.2004 | 04.2007 | 03.0655-0007.2 | 370007 | DISTANCE SENSOR | 9G433311077 , 6804 6475AA , 9M68-2M113-AA , C2C 39935 , 163 540 12 17 , 30665607 | |
| | | 3) Coull | 04.2000 | 04.2007 | 03.0655-0007.2 | 370007 | DISTANCE SENSOR | 9G433311077 , 6804 6475AA , 9M68-2M113-AA , C2C 39935 , 163 540 12 17 , 30665607 | |
| | C 230 | 3) Coull | 06.2005 | 04.2007 | 03.0655-0007.2 | 370007 | DISTANCE SENSOR | 9G433311077 , 6804 6475AA , 9M68-2M113-AA , C2C 39935 , 163 540 12 17 , 30665607 | |
| | C 230 Kompressor | 3) Coull | 02.2004 | 04.2007 | 03.0655-0007.2 | 370007 | DISTANCE SENSOR | 9G433311077 , 6804 6475AA , 9M68-2M113-AA , C2C 39935 , 163 540 12 17 , 30665607 | |



| | | | | | | | |
|--|--|--|--|--|--------------------|---|--------------------------------------|
| | | | | | Bezeichnung | OE-Nummern zu ATE Artikelnummern | z.B. Vorsachnummern / diverse |
|--|--|--|--|--|--------------------|---|--------------------------------------|

MERCEDES BENZ

| | | | | | | | | | |
|-----------------------------------|---------------------|----------|---------|---------|----------------|--------|-----------------|--|--|
| C-Klasse (W203) Limousine (00-07) | C 240 | 3) Coull | 04.2000 | 04.2007 | 03.0655-0007.2 | 370007 | DISTANCE SENSOR | 9G433311077 , 6804 6475AA , 9M68-2M113-AA , C2C 39935 , 163 540 12 17 , 30665607 | |
| | C 240 4-matic | 3) Coull | 07.2002 | 04.2007 | 03.0655-0007.2 | 370007 | DISTANCE SENSOR | 9G433311077 , 6804 6475AA , 9M68-2M113-AA , C2C 39935 , 163 540 12 17 , 30665607 | |
| | C 270 CDI | 3) Coull | 08.2000 | 04.2007 | 03.0655-0007.2 | 370007 | DISTANCE SENSOR | 9G433311077 , 6804 6475AA , 9M68-2M113-AA , C2C 39935 , 163 540 12 17 , 30665607 | |
| | C 280 | 3) Coull | 06.2005 | 04.2007 | 03.0655-0007.2 | 370007 | DISTANCE SENSOR | 9G433311077 , 6804 6475AA , 9M68-2M113-AA , C2C 39935 , 163 540 12 17 , 30665607 | |
| | C 280 4-matic | 3) Coull | 06.2005 | 04.2007 | 03.0655-0007.2 | 370007 | DISTANCE SENSOR | 9G433311077 , 6804 6475AA , 9M68-2M113-AA , C2C 39935 , 163 540 12 17 , 30665607 | |
| | C 30 CDI AMG | 3) Coull | 01.2003 | 04.2007 | 03.0655-0007.2 | 370007 | DISTANCE SENSOR | 9G433311077 , 6804 6475AA , 9M68-2M113-AA , C2C 39935 , 163 540 12 17 , 30665607 | |
| | C 32 AMG Kompressor | 3) Coull | 03.2001 | 04.2007 | 03.0655-0007.2 | 370007 | DISTANCE SENSOR | 9G433311077 , 6804 6475AA , 9M68-2M113-AA , C2C 39935 , 163 540 12 17 , 30665607 | |
| | C 320 | 3) Coull | 04.2000 | 04.2007 | 03.0655-0007.2 | 370007 | DISTANCE SENSOR | 9G433311077 , 6804 6475AA , 9M68-2M113-AA , C2C 39935 , 163 540 12 17 , 30665607 | |
| | C 320 4-matic | 3) Coull | 07.2002 | 04.2007 | 03.0655-0007.2 | 370007 | DISTANCE SENSOR | 9G433311077 , 6804 6475AA , 9M68-2M113-AA , C2C 39935 , 163 540 12 17 , 30665607 | |



| | | | | | | | |
|--|--|--|--|--|--------------------|---|--------------------------------------|
| | | | | | Bezeichnung | OE-Nummern zu ATE Artikelnummern | z.B. Vorsachnummern / diverse |
|--|--|--|--|--|--------------------|---|--------------------------------------|

MERCEDES BENZ

| | | | | | | | | |
|-----------------------------------|--------------------|----------|---------|---------|----------------|--------|-----------------|--|
| C-Klasse (W203) Limousine (00-07) | C 320 CDI | 3) Coull | 02.2005 | 04.2007 | 03.0655-0007.2 | 370007 | DISTANCE SENSOR | 9G433311077 , 6804 6475AA , 9M68-2M113-AA , C2C 39935 , 163 540 12 17 , 30665607 |
| | C 350 | 3) Coull | 06.2005 | 04.2007 | 03.0655-0007.2 | 370007 | DISTANCE SENSOR | 9G433311077 , 6804 6475AA , 9M68-2M113-AA , C2C 39935 , 163 540 12 17 , 30665607 |
| | C 350 4-matic | 3) Coull | 06.2005 | 04.2007 | 03.0655-0007.2 | 370007 | DISTANCE SENSOR | 9G433311077 , 6804 6475AA , 9M68-2M113-AA , C2C 39935 , 163 540 12 17 , 30665607 |
| | C 55 AMG | 3) Coull | 02.2004 | 04.2007 | 03.0655-0007.2 | 370007 | DISTANCE SENSOR | 9G433311077 , 6804 6475AA , 9M68-2M113-AA , C2C 39935 , 163 540 12 17 , 30665607 |
| CLK-Klasse (A208) Cabrio (98-03) | CLK 200 | 3) Coull | | 06.2003 | 03.0655-0007.2 | 370007 | DISTANCE SENSOR | 9G433311077 , 6804 6475AA , 9M68-2M113-AA , C2C 39935 , 163 540 12 17 , 30665607 |
| | CLK 200 Kompressor | 3) Coull | 06.2000 | 06.2003 | 03.0655-0007.2 | 370007 | DISTANCE SENSOR | 9G433311077 , 6804 6475AA , 9M68-2M113-AA , C2C 39935 , 163 540 12 17 , 30665607 |
| | | 3) Coull | | 06.2003 | 03.0655-0007.2 | 370007 | DISTANCE SENSOR | 9G433311077 , 6804 6475AA , 9M68-2M113-AA , C2C 39935 , 163 540 12 17 , 30665607 |
| | CLK 230 Kompressor | 3) Coull | | 06.2003 | 03.0655-0007.2 | 370007 | DISTANCE SENSOR | 9G433311077 , 6804 6475AA , 9M68-2M113-AA , C2C 39935 , 163 540 12 17 , 30665607 |
| | | 3) Coull | 06.2000 | 06.2003 | 03.0655-0007.2 | 370007 | DISTANCE SENSOR | 9G433311077 , 6804 6475AA , 9M68-2M113-AA , C2C 39935 , 163 540 12 17 , 30665607 |



| | | | | | | | |
|--|----------|--|--|--|--------------------|---|--|
| | i | | | | Bezeichnung | OE-Nummern zu ATE Artikelnummern | i z.B. Vorsachnummern / diverse |
|--|----------|--|--|--|--------------------|---|--|

MERCEDES BENZ

| | | | | | | | | | |
|----------------------------------|--------------------|----------|---------|---------|----------------|--------|-----------------|--|--|
| CLK-Klasse (A209) Cabrio (03-09) | CLK 200 CGI | 3) Coull | 05.2003 | 12.2009 | 03.0655-0007.2 | 370007 | DISTANCE SENSOR | 9G433311077 , 6804 6475AA , 9M68-2M113-AA , C2C 39935 , 163 540 12 17 , 30665607 | |
| | CLK 200 Kompressor | 3) Coull | 05.2003 | 12.2009 | 03.0655-0007.2 | 370007 | DISTANCE SENSOR | 9G433311077 , 6804 6475AA , 9M68-2M113-AA , C2C 39935 , 163 540 12 17 , 30665607 | |
| | | 3) Coull | 10.2006 | 12.2009 | 03.0655-0007.2 | 370007 | DISTANCE SENSOR | 9G433311077 , 6804 6475AA , 9M68-2M113-AA , C2C 39935 , 163 540 12 17 , 30665607 | |
| | CLK 240 | 3) Coull | 05.2003 | 12.2009 | 03.0655-0007.2 | 370007 | DISTANCE SENSOR | 9G433311077 , 6804 6475AA , 9M68-2M113-AA , C2C 39935 , 163 540 12 17 , 30665607 | |
| | CLK 280 | 3) Coull | 05.2005 | 12.2009 | 03.0655-0007.2 | 370007 | DISTANCE SENSOR | 9G433311077 , 6804 6475AA , 9M68-2M113-AA , C2C 39935 , 163 540 12 17 , 30665607 | |
| | CLK 320 | 3) Coull | 05.2003 | 12.2009 | 03.0655-0007.2 | 370007 | DISTANCE SENSOR | 9G433311077 , 6804 6475AA , 9M68-2M113-AA , C2C 39935 , 163 540 12 17 , 30665607 | |
| | CLK 320 CDI | 3) Coull | 05.2005 | 12.2009 | 03.0655-0007.2 | 370007 | DISTANCE SENSOR | 9G433311077 , 6804 6475AA , 9M68-2M113-AA , C2C 39935 , 163 540 12 17 , 30665607 | |
| | CLK 350 | 3) Coull | 05.2005 | 12.2009 | 03.0655-0007.2 | 370007 | DISTANCE SENSOR | 9G433311077 , 6804 6475AA , 9M68-2M113-AA , C2C 39935 , 163 540 12 17 , 30665607 | |
| | CLK 500 | 3) Coull | 05.2003 | 12.2009 | 03.0655-0007.2 | 370007 | DISTANCE SENSOR | 9G433311077 , 6804 6475AA , 9M68-2M113-AA , C2C 39935 , 163 540 12 17 , 30665607 | |



| | | | | | | | |
|--|--|--|--|--|--------------------|---|--------------------------------------|
| | | | | | Bezeichnung | OE-Nummern zu ATE Artikelnummern | z.B. Vorsachnummern / diverse |
|--|--|--|--|--|--------------------|---|--------------------------------------|

MERCEDES BENZ

| | | | | | | | | |
|----------------------------------|--------------------|---------|---------|---------|----------------|--------|-----------------|--|
| CLK-Klasse (A209) Cabrio (03-09) | CLK 500 | 3) Coup | 06.2006 | 12.2009 | 03.0655-0007.2 | 370007 | DISTANCE SENSOR | 9G433311077 , 6804 6475AA , 9M68-2M113-AA , C2C 39935 , 163 540 12 17 , 30665607 |
| | CLK 55 AMG | 3) Coup | 05.2003 | 12.2009 | 03.0655-0007.2 | 370007 | DISTANCE SENSOR | 9G433311077 , 6804 6475AA , 9M68-2M113-AA , C2C 39935 , 163 540 12 17 , 30665607 |
| | CLK 63 AMG | 3) Coup | 04.2006 | 12.2009 | 03.0655-0007.2 | 370007 | DISTANCE SENSOR | 9G433311077 , 6804 6475AA , 9M68-2M113-AA , C2C 39935 , 163 540 12 17 , 30665607 |
| CLK-Klasse (C208) Coupe (97-02) | CLK 200 | 3) Coup | | 06.2002 | 03.0655-0007.2 | 370007 | DISTANCE SENSOR | 9G433311077 , 6804 6475AA , 9M68-2M113-AA , C2C 39935 , 163 540 12 17 , 30665607 |
| | CLK 200 Kompressor | 3) Coup | | 06.2002 | 03.0655-0007.2 | 370007 | DISTANCE SENSOR | 9G433311077 , 6804 6475AA , 9M68-2M113-AA , C2C 39935 , 163 540 12 17 , 30665607 |
| | | 3) Coup | 06.2000 | 06.2002 | 03.0655-0007.2 | 370007 | DISTANCE SENSOR | 9G433311077 , 6804 6475AA , 9M68-2M113-AA , C2C 39935 , 163 540 12 17 , 30665607 |
| | CLK 230 Kompressor | 3) Coup | | 06.2002 | 03.0655-0007.2 | 370007 | DISTANCE SENSOR | 9G433311077 , 6804 6475AA , 9M68-2M113-AA , C2C 39935 , 163 540 12 17 , 30665607 |
| | | 3) Coup | 06.2000 | 06.2002 | 03.0655-0007.2 | 370007 | DISTANCE SENSOR | 9G433311077 , 6804 6475AA , 9M68-2M113-AA , C2C 39935 , 163 540 12 17 , 30665607 |
| CLK-Klasse (C209) Coupe (02-09) | CLK 200 CGI | 3) Coup | 09.2002 | 04.2009 | 03.0655-0007.2 | 370007 | DISTANCE SENSOR | 9G433311077 , 6804 6475AA , 9M68-2M113-AA , C2C 39935 , 163 540 12 17 , 30665607 |



| | | | | | | | |
|--|--|--|--|--|--------------------|---|--------------------------------------|
| | | | | | Bezeichnung | OE-Nummern zu ATE Artikelnummern | z.B. Vorsachnummern / diverse |
|--|--|--|--|--|--------------------|---|--------------------------------------|

MERCEDES BENZ

| | | | | | | | | |
|---------------------------------|--------------------|---------|---------|---------|----------------|--------|-----------------|--|
| CLK-Klasse (C209) Coupe (02-09) | CLK 200 Kompressor | 3) Coup | 09.2002 | 04.2009 | 03.0655-0007.2 | 370007 | DISTANCE SENSOR | 9G433311077 , 6804 6475AA , 9M68-2M113-AA , C2C 39935 , 163 540 12 17 , 30665607 |
| | | 3) Coup | 10.2006 | 04.2009 | 03.0655-0007.2 | 370007 | DISTANCE SENSOR | 9G433311077 , 6804 6475AA , 9M68-2M113-AA , C2C 39935 , 163 540 12 17 , 30665607 |
| | CLK 220 CDI | 3) Coup | 05.2005 | 04.2009 | 03.0655-0007.2 | 370007 | DISTANCE SENSOR | 9G433311077 , 6804 6475AA , 9M68-2M113-AA , C2C 39935 , 163 540 12 17 , 30665607 |
| | CLK 240 | 3) Coup | 05.2002 | 04.2009 | 03.0655-0007.2 | 370007 | DISTANCE SENSOR | 9G433311077 , 6804 6475AA , 9M68-2M113-AA , C2C 39935 , 163 540 12 17 , 30665607 |
| | CLK 270 CDI | 3) Coup | 10.2002 | 04.2009 | 03.0655-0007.2 | 370007 | DISTANCE SENSOR | 9G433311077 , 6804 6475AA , 9M68-2M113-AA , C2C 39935 , 163 540 12 17 , 30665607 |
| | CLK 280 | 3) Coup | 05.2005 | 04.2009 | 03.0655-0007.2 | 370007 | DISTANCE SENSOR | 9G433311077 , 6804 6475AA , 9M68-2M113-AA , C2C 39935 , 163 540 12 17 , 30665607 |
| | CLK 320 | 3) Coup | 05.2002 | 04.2009 | 03.0655-0007.2 | 370007 | DISTANCE SENSOR | 9G433311077 , 6804 6475AA , 9M68-2M113-AA , C2C 39935 , 163 540 12 17 , 30665607 |
| | CLK 320 CDI | 3) Coup | 05.2005 | 04.2009 | 03.0655-0007.2 | 370007 | DISTANCE SENSOR | 9G433311077 , 6804 6475AA , 9M68-2M113-AA , C2C 39935 , 163 540 12 17 , 30665607 |
| | CLK 350 | 3) Coup | 05.2005 | 04.2009 | 03.0655-0007.2 | 370007 | DISTANCE SENSOR | 9G433311077 , 6804 6475AA , 9M68-2M113-AA , C2C 39935 , 163 540 12 17 , 30665607 |



| | | | | | | | |
|--|----------|--|--|--|--------------------|---|--|
| | i | | | | Bezeichnung | OE-Nummern zu ATE Artikelnummern | i z.B. Vorsachnummern / diverse |
|--|----------|--|--|--|--------------------|---|--|

MERCEDES BENZ

| | | | | | | | | | |
|---------------------------------|----------------|---------|---------|---------|----------------|--------|-----------------|--|--|
| CLK-Klasse (C209) Coupe (02-09) | CLK 500 | 3) Coup | 05.2002 | 04.2009 | 03.0655-0007.2 | 370007 | DISTANCE SENSOR | 9G433311077 , 6804 6475AA , 9M68-2M113-AA , C2C 39935 , 163 540 12 17 , 30665607 | |
| | | 3) Coup | 06.2006 | 04.2009 | 03.0655-0007.2 | 370007 | DISTANCE SENSOR | 9G433311077 , 6804 6475AA , 9M68-2M113-AA , C2C 39935 , 163 540 12 17 , 30665607 | |
| | CLK 55 AMG | 3) Coup | 09.2002 | 04.2009 | 03.0655-0007.2 | 370007 | DISTANCE SENSOR | 9G433311077 , 6804 6475AA , 9M68-2M113-AA , C2C 39935 , 163 540 12 17 , 30665607 | |
| | CLK 63 AMG | 3) Coup | 04.2006 | 04.2009 | 03.0655-0007.2 | 370007 | DISTANCE SENSOR | 9G433311077 , 6804 6475AA , 9M68-2M113-AA , C2C 39935 , 163 540 12 17 , 30665607 | |
| CL-Klasse (C216) Coupe (06-) | CL 500 | 3) Coup | 02.2011 | | 03.0655-0007.2 | 370007 | DISTANCE SENSOR | 9G433311077 , 6804 6475AA , 9M68-2M113-AA , C2C 39935 , 163 540 12 17 , 30665607 | |
| | | 3) Coup | 07.2006 | | 03.0655-0007.2 | 370007 | DISTANCE SENSOR | 9G433311077 , 6804 6475AA , 9M68-2M113-AA , C2C 39935 , 163 540 12 17 , 30665607 | |
| | | 3) Coup | | | 03.0655-0007.2 | 370007 | DISTANCE SENSOR | 9G433311077 , 6804 6475AA , 9M68-2M113-AA , C2C 39935 , 163 540 12 17 , 30665607 | |
| | CL 500 4-matic | 3) Coup | | | 03.0655-0007.2 | 370007 | DISTANCE SENSOR | 9G433311077 , 6804 6475AA , 9M68-2M113-AA , C2C 39935 , 163 540 12 17 , 30665607 | |
| | | 3) Coup | 02.2011 | | 03.0655-0007.2 | 370007 | DISTANCE SENSOR | 9G433311077 , 6804 6475AA , 9M68-2M113-AA , C2C 39935 , 163 540 12 17 , 30665607 | |



| | | | | | | | |
|--|----------|--|--|--|--------------------|---|--|
| | i | | | | Bezeichnung | OE-Nummern zu ATE Artikelnummern | i z.B. Vorsachnummern / diverse |
|--|----------|--|--|--|--------------------|---|--|

MERCEDES BENZ

| | | | | | | | | | |
|------------------------------|-----------------------|---------|---------|--|----------------|--------|-----------------|--|--|
| CL-Klasse (C216) Coupe (06-) | CL 500 4-matic | 3) Coup | 03.2008 | | 03.0655-0007.2 | 370007 | DISTANCE SENSOR | 9G433311077 , 6804 6475AA , 9M68-2M113-AA , C2C 39935 , 163 540 12 17 , 30665607 | |
| | CL 500 BlueEfficiency | 3) Coup | | | 03.0655-0007.2 | 370007 | DISTANCE SENSOR | 9G433311077 , 6804 6475AA , 9M68-2M113-AA , C2C 39935 , 163 540 12 17 , 30665607 | |
| | | 3) Coup | 10.2010 | | 03.0655-0007.2 | 370007 | DISTANCE SENSOR | 9G433311077 , 6804 6475AA , 9M68-2M113-AA , C2C 39935 , 163 540 12 17 , 30665607 | |
| | CL 600 | 3) Coup | 07.2006 | | 03.0655-0007.2 | 370007 | DISTANCE SENSOR | 9G433311077 , 6804 6475AA , 9M68-2M113-AA , C2C 39935 , 163 540 12 17 , 30665607 | |
| | | 3) Coup | | | 03.0655-0007.2 | 370007 | DISTANCE SENSOR | 9G433311077 , 6804 6475AA , 9M68-2M113-AA , C2C 39935 , 163 540 12 17 , 30665607 | |
| | CL 63 AMG | 3) Coup | 02.2011 | | 03.0655-0007.2 | 370007 | DISTANCE SENSOR | 9G433311077 , 6804 6475AA , 9M68-2M113-AA , C2C 39935 , 163 540 12 17 , 30665607 | |
| | | 3) Coup | 01.2010 | | 03.0655-0007.2 | 370007 | DISTANCE SENSOR | 9G433311077 , 6804 6475AA , 9M68-2M113-AA , C2C 39935 , 163 540 12 17 , 30665607 | |
| | | 3) Coup | | | 03.0655-0007.2 | 370007 | DISTANCE SENSOR | 9G433311077 , 6804 6475AA , 9M68-2M113-AA , C2C 39935 , 163 540 12 17 , 30665607 | |
| | | 3) Coup | 01.2007 | | 03.0655-0007.2 | 370007 | DISTANCE SENSOR | 9G433311077 , 6804 6475AA , 9M68-2M113-AA , C2C 39935 , 163 540 12 17 , 30665607 | |



| | | | | | | | |
|--|--|--|--|--|--------------------|---|--------------------------------------|
| | | | | | Bezeichnung | OE-Nummern zu ATE Artikelnummern | z.B. Vorsachnummern / diverse |
|--|--|--|--|--|--------------------|---|--------------------------------------|

MERCEDES BENZ

| | | | | | | | | |
|------------------------------|--------------------|----------|---------|---------|----------------|--------|-----------------|--|
| CL-Klasse (C216) Coupe (06-) | CL 65 AMG | 3) Coupl | | | 03.0655-0007.2 | 370007 | DISTANCE SENSOR | 9G433311077 , 6804 6475AA , 9M68-2M113-AA , C2C 39935 , 163 540 12 17 , 30665607 |
| | | 3) Coupl | 01.2007 | | 03.0655-0007.2 | 370007 | DISTANCE SENSOR | 9G433311077 , 6804 6475AA , 9M68-2M113-AA , C2C 39935 , 163 540 12 17 , 30665607 |
| | | 3) Coupl | 02.2011 | | 03.0655-0007.2 | 370007 | DISTANCE SENSOR | 9G433311077 , 6804 6475AA , 9M68-2M113-AA , C2C 39935 , 163 540 12 17 , 30665607 |
| GL-Klasse (X164) (06-12) | GL 320 CDI 4-matic | 3) Coupl | 03.2006 | 06.2012 | 03.0655-0007.2 | 370007 | DISTANCE SENSOR | 9G433311077 , 6804 6475AA , 9M68-2M113-AA , C2C 39935 , 163 540 12 17 , 30665607 |
| | GL 350 BT 4-matic | 3) Coupl | 05.2009 | 06.2012 | 03.0655-0007.2 | 370007 | DISTANCE SENSOR | 9G433311077 , 6804 6475AA , 9M68-2M113-AA , C2C 39935 , 163 540 12 17 , 30665607 |
| | GL 350 CDI 4-matic | 3) Coupl | 05.2009 | 06.2012 | 03.0655-0007.2 | 370007 | DISTANCE SENSOR | 9G433311077 , 6804 6475AA , 9M68-2M113-AA , C2C 39935 , 163 540 12 17 , 30665607 |
| | GL 420 CDI 4-matic | 3) Coupl | 03.2006 | 06.2012 | 03.0655-0007.2 | 370007 | DISTANCE SENSOR | 9G433311077 , 6804 6475AA , 9M68-2M113-AA , C2C 39935 , 163 540 12 17 , 30665607 |
| | GL 450 4-matic | 3) Coupl | 03.2006 | 06.2012 | 03.0655-0007.2 | 370007 | DISTANCE SENSOR | 9G433311077 , 6804 6475AA , 9M68-2M113-AA , C2C 39935 , 163 540 12 17 , 30665607 |
| | GL 450 CDI 4-matic | 3) Coupl | 05.2009 | 06.2012 | 03.0655-0007.2 | 370007 | DISTANCE SENSOR | 9G433311077 , 6804 6475AA , 9M68-2M113-AA , C2C 39935 , 163 540 12 17 , 30665607 |



| | | | | | | | |
|--|--|--|--|--|--------------------|---|--------------------------------------|
| | | | | | Bezeichnung | OE-Nummern zu ATE Artikelnummern | z.B. Vorsachnummern / diverse |
|--|--|--|--|--|--------------------|---|--------------------------------------|

MERCEDES BENZ

| | | | | | | | | |
|--------------------------|----------------|----------|---------|---------|----------------|--------|-----------------|--|
| GL-Klasse (X164) (06-12) | GL 500 4-matic | 3) Coull | 03.2006 | 06.2012 | 03.0655-0007.2 | 370007 | DISTANCE SENSOR | 9G433311077 , 6804 6475AA , 9M68-2M113-AA , C2C 39935 , 163 540 12 17 , 30665607 |
| M-Klasse (W163) (98-05) | ML 270 CDI | 3) Coull | 09.1999 | 06.2005 | 03.0655-0007.2 | 370007 | DISTANCE SENSOR | 9G433311077 , 6804 6475AA , 9M68-2M113-AA , C2C 39935 , 163 540 12 17 , 30665607 |
| | ML 320 | 3) Coull | 03.1998 | 08.2002 | 03.0655-0007.2 | 370007 | DISTANCE SENSOR | 9G433311077 , 6804 6475AA , 9M68-2M113-AA , C2C 39935 , 163 540 12 17 , 30665607 |
| | ML 350 | 3) Coull | 09.2002 | 06.2005 | 03.0655-0007.2 | 370007 | DISTANCE SENSOR | 9G433311077 , 6804 6475AA , 9M68-2M113-AA , C2C 39935 , 163 540 12 17 , 30665607 |
| | ML 400 CDI | 3) Coull | 07.2001 | 06.2005 | 03.0655-0007.2 | 370007 | DISTANCE SENSOR | 9G433311077 , 6804 6475AA , 9M68-2M113-AA , C2C 39935 , 163 540 12 17 , 30665607 |
| | ML 430 | 3) Coull | 09.1998 | 06.2005 | 03.0655-0007.2 | 370007 | DISTANCE SENSOR | 9G433311077 , 6804 6475AA , 9M68-2M113-AA , C2C 39935 , 163 540 12 17 , 30665607 |
| | ML 500 | 3) Coull | 07.2001 | 06.2005 | 03.0655-0007.2 | 370007 | DISTANCE SENSOR | 9G433311077 , 6804 6475AA , 9M68-2M113-AA , C2C 39935 , 163 540 12 17 , 30665607 |
| | ML 55 AMG | 3) Coull | 09.1999 | 06.2005 | 03.0655-0007.2 | 370007 | DISTANCE SENSOR | 9G433311077 , 6804 6475AA , 9M68-2M113-AA , C2C 39935 , 163 540 12 17 , 30665607 |
| M-Klasse (W164) (05-11) | ML 280 CDI | 3) Coull | 07.2005 | 05.2011 | 03.0655-0007.2 | 370007 | DISTANCE SENSOR | 9G433311077 , 6804 6475AA , 9M68-2M113-AA , C2C 39935 , 163 540 12 17 , 30665607 |



| | | | | | | | |
|--|----------|--|--|--|--------------------|---|--|
| | i | | | | Bezeichnung | OE-Nummern zu ATE Artikelnummern | i z.B. Vorsachnummern / diverse |
|--|----------|--|--|--|--------------------|---|--|

MERCEDES BENZ

| | | | | | | | | | |
|-------------------------|--------------------|----------|---------|---------|----------------|--------|-----------------|--|--|
| M-Klasse (W164) (05-11) | ML 300 | 3) Coull | 05.2009 | 05.2011 | 03.0655-0007.2 | 370007 | DISTANCE SENSOR | 9G433311077 , 6804 6475AA , 9M68-2M113-AA , C2C 39935 , 163 540 12 17 , 30665607 | |
| | ML 300 CDI 4-matic | 3) Coull | 07.2009 | 05.2011 | 03.0655-0007.2 | 370007 | DISTANCE SENSOR | 9G433311077 , 6804 6475AA , 9M68-2M113-AA , C2C 39935 , 163 540 12 17 , 30665607 | |
| | ML 320 CDI | 3) Coull | 07.2005 | 05.2011 | 03.0655-0007.2 | 370007 | DISTANCE SENSOR | 9G433311077 , 6804 6475AA , 9M68-2M113-AA , C2C 39935 , 163 540 12 17 , 30665607 | |
| | ML 350 | 3) Coull | 07.2005 | 05.2011 | 03.0655-0007.2 | 370007 | DISTANCE SENSOR | 9G433311077 , 6804 6475AA , 9M68-2M113-AA , C2C 39935 , 163 540 12 17 , 30665607 | |
| | ML 350 BT 4-matic | 3) Coull | 05.2009 | 05.2011 | 03.0655-0007.2 | 370007 | DISTANCE SENSOR | 9G433311077 , 6804 6475AA , 9M68-2M113-AA , C2C 39935 , 163 540 12 17 , 30665607 | |
| | ML 350 CDI 4-matic | 3) Coull | | | 03.0655-0007.2 | 370007 | DISTANCE SENSOR | 9G433311077 , 6804 6475AA , 9M68-2M113-AA , C2C 39935 , 163 540 12 17 , 30665607 | |
| | | 3) Coull | 07.2009 | 05.2011 | 03.0655-0007.2 | 370007 | DISTANCE SENSOR | 9G433311077 , 6804 6475AA , 9M68-2M113-AA , C2C 39935 , 163 540 12 17 , 30665607 | |
| | ML 420 CDI 4-matic | 3) Coull | 04.2006 | 05.2011 | 03.0655-0007.2 | 370007 | DISTANCE SENSOR | 9G433311077 , 6804 6475AA , 9M68-2M113-AA , C2C 39935 , 163 540 12 17 , 30665607 | |
| | ML 450 CDI 4-matic | 3) Coull | 09.2009 | 05.2011 | 03.0655-0007.2 | 370007 | DISTANCE SENSOR | 9G433311077 , 6804 6475AA , 9M68-2M113-AA , C2C 39935 , 163 540 12 17 , 30665607 | |



| | | | | | | | |
|--|----------|--|--|--|--------------------|---|--|
| | i | | | | Bezeichnung | OE-Nummern zu ATE Artikelnummern | i z.B. Vorsachnummern / diverse |
|--|----------|--|--|--|--------------------|---|--|

MERCEDES BENZ

| | | | | | | | | |
|------------------------------|-----------------------|----------|---------|---------|----------------|--------|-----------------|--|
| M-Klasse (W164) (05-11) | ML 450 Hybrid 4-matic | 3) Coull | 08.2009 | 05.2011 | 03.0655-0007.2 | 370007 | DISTANCE SENSOR | 9G433311077 , 6804 6475AA , 9M68-2M113-AA , C2C 39935 , 163 540 12 17 , 30665607 |
| | ML 500 | 3) Coull | 07.2005 | 05.2011 | 03.0655-0007.2 | 370007 | DISTANCE SENSOR | 9G433311077 , 6804 6475AA , 9M68-2M113-AA , C2C 39935 , 163 540 12 17 , 30665607 |
| | ML 63 AMG | 3) Coull | 09.2005 | 05.2011 | 03.0655-0007.2 | 370007 | DISTANCE SENSOR | 9G433311077 , 6804 6475AA , 9M68-2M113-AA , C2C 39935 , 163 540 12 17 , 30665607 |
| R-Klasse (W251,V251) (06-12) | R 280 | 3) Coull | 01.2007 | 10.2012 | 03.0655-0007.2 | 370007 | DISTANCE SENSOR | 9G433311077 , 6804 6475AA , 9M68-2M113-AA , C2C 39935 , 163 540 12 17 , 30665607 |
| | R 280 CDI | 3) Coull | 05.2006 | 10.2012 | 03.0655-0007.2 | 370007 | DISTANCE SENSOR | 9G433311077 , 6804 6475AA , 9M68-2M113-AA , C2C 39935 , 163 540 12 17 , 30665607 |
| | R 280 CDI 4-matic | 3) Coull | 11.2005 | 10.2012 | 03.0655-0007.2 | 370007 | DISTANCE SENSOR | 9G433311077 , 6804 6475AA , 9M68-2M113-AA , C2C 39935 , 163 540 12 17 , 30665607 |
| | R 300 | 3) Coull | 01.2007 | 10.2012 | 03.0655-0007.2 | 370007 | DISTANCE SENSOR | 9G433311077 , 6804 6475AA , 9M68-2M113-AA , C2C 39935 , 163 540 12 17 , 30665607 |
| | R 300 CDI | 3) Coull | 07.2009 | 10.2012 | 03.0655-0007.2 | 370007 | DISTANCE SENSOR | 9G433311077 , 6804 6475AA , 9M68-2M113-AA , C2C 39935 , 163 540 12 17 , 30665607 |
| | R 300 CDI 4-matic | 3) Coull | 07.2009 | 10.2012 | 03.0655-0007.2 | 370007 | DISTANCE SENSOR | 9G433311077 , 6804 6475AA , 9M68-2M113-AA , C2C 39935 , 163 540 12 17 , 30665607 |



| | | | | | | | |
|--|--|--|--|--|--------------------|---|--------------------------------------|
| | | | | | Bezeichnung | OE-Nummern zu ATE Artikelnummern | z.B. Vorsachnummern / diverse |
|--|--|--|--|--|--------------------|---|--------------------------------------|

MERCEDES BENZ

| | | | | | | | | |
|------------------------------|-------------------|----------|---------|---------|----------------|--------|-----------------|--|
| R-Klasse (W251,V251) (06-12) | R 320 CDI 4-matic | 3) Coull | 11.2005 | 10.2012 | 03.0655-0007.2 | 370007 | DISTANCE SENSOR | 9G433311077 , 6804 6475AA , 9M68-2M113-AA , C2C 39935 , 163 540 12 17 , 30665607 |
| | R 350 | 3) Coull | 11.2005 | 10.2012 | 03.0655-0007.2 | 370007 | DISTANCE SENSOR | 9G433311077 , 6804 6475AA , 9M68-2M113-AA , C2C 39935 , 163 540 12 17 , 30665607 |
| | R 350 4-matic | 3) Coull | 01.2006 | 10.2012 | 03.0655-0007.2 | 370007 | DISTANCE SENSOR | 9G433311077 , 6804 6475AA , 9M68-2M113-AA , C2C 39935 , 163 540 12 17 , 30665607 |
| | R 350 BT 4-matic | 3) Coull | 05.2009 | 10.2012 | 03.0655-0007.2 | 370007 | DISTANCE SENSOR | 9G433311077 , 6804 6475AA , 9M68-2M113-AA , C2C 39935 , 163 540 12 17 , 30665607 |
| | R 350 CDI 4-matic | 3) Coull | 05.2009 | 10.2012 | 03.0655-0007.2 | 370007 | DISTANCE SENSOR | 9G433311077 , 6804 6475AA , 9M68-2M113-AA , C2C 39935 , 163 540 12 17 , 30665607 |
| | R 500 4-matic | 3) Coull | 11.2005 | 10.2012 | 03.0655-0007.2 | 370007 | DISTANCE SENSOR | 9G433311077 , 6804 6475AA , 9M68-2M113-AA , C2C 39935 , 163 540 12 17 , 30665607 |
| | R 63 AMG | 3) Coull | 11.2005 | 10.2012 | 03.0655-0007.2 | 370007 | DISTANCE SENSOR | 9G433311077 , 6804 6475AA , 9M68-2M113-AA , C2C 39935 , 163 540 12 17 , 30665607 |
| S-Klasse (W220) (98-06) | S 350 | HL | 09.2002 | 03.2006 | 24.3426-9979.5 | 240579 | FAUSTSATTEL | 002 420 65 83 |
| | S 350 4-matic | HL | 06.2003 | | 24.3426-9979.5 | 240579 | FAUSTSATTEL | 002 420 65 83 |
| S-Klasse (W221) (06-13) | S 250 CDI | 3) Coull | 01.2011 | 05.2013 | 03.0655-0007.2 | 370007 | DISTANCE SENSOR | 9G433311077 , 6804 6475AA , 9M68-2M113-AA , C2C 39935 , 163 540 12 17 , 30665607 |



| | | | | | | | |
|--|--|--|--|--|-------------|----------------------------------|-------------------------------|
| | | | | | Bezeichnung | OE-Nummern zu ATE Artikelnummern | z.B. Vorsachnummern / diverse |
|--|--|--|--|--|-------------|----------------------------------|-------------------------------|

MERCEDES BENZ

| | | | | | | | | | |
|-------------------------|-----------------------|----------|---------|---------|----------------|--------|-----------------|--|--|
| S-Klasse (W221) (06-13) | S 280 / S 300 | 3) Coull | 04.2006 | | 03.0655-0007.2 | 370007 | DISTANCE SENSOR | 9G433311077 , 6804 6475AA , 9M68-2M113-AA , C2C 39935 , 163 540 12 17 , 30665607 | |
| | | 3) Coull | | 05.2013 | 03.0655-0007.2 | 370007 | DISTANCE SENSOR | 9G433311077 , 6804 6475AA , 9M68-2M113-AA , C2C 39935 , 163 540 12 17 , 30665607 | |
| | S 320 CDI | 3) Coull | 12.2005 | | 03.0655-0007.2 | 370007 | DISTANCE SENSOR | 9G433311077 , 6804 6475AA , 9M68-2M113-AA , C2C 39935 , 163 540 12 17 , 30665607 | |
| | | 3) Coull | | 05.2013 | 03.0655-0007.2 | 370007 | DISTANCE SENSOR | 9G433311077 , 6804 6475AA , 9M68-2M113-AA , C2C 39935 , 163 540 12 17 , 30665607 | |
| | S 320 CDI / S 350 CDI | 3) Coull | 12.2005 | | 03.0655-0007.2 | 370007 | DISTANCE SENSOR | 9G433311077 , 6804 6475AA , 9M68-2M113-AA , C2C 39935 , 163 540 12 17 , 30665607 | |
| | | 3) Coull | | 05.2013 | 03.0655-0007.2 | 370007 | DISTANCE SENSOR | 9G433311077 , 6804 6475AA , 9M68-2M113-AA , C2C 39935 , 163 540 12 17 , 30665607 | |
| | S 320 CDI 4-matic | 3) Coull | | 05.2013 | 03.0655-0007.2 | 370007 | DISTANCE SENSOR | 9G433311077 , 6804 6475AA , 9M68-2M113-AA , C2C 39935 , 163 540 12 17 , 30665607 | |
| | | 3) Coull | 12.2005 | | 03.0655-0007.2 | 370007 | DISTANCE SENSOR | 9G433311077 , 6804 6475AA , 9M68-2M113-AA , C2C 39935 , 163 540 12 17 , 30665607 | |
| | | 3) Coull | 05.2006 | | 03.0655-0007.2 | 370007 | DISTANCE SENSOR | 9G433311077 , 6804 6475AA , 9M68-2M113-AA , C2C 39935 , 163 540 12 17 , 30665607 | |



| | | | | | | | |
|--|--|--|--|--|--------------------|---|--------------------------------------|
| | | | | | Bezeichnung | OE-Nummern zu ATE Artikelnummern | z.B. Vorsachnummern / diverse |
|--|--|--|--|--|--------------------|---|--------------------------------------|

MERCEDES BENZ

| | | | | | | | | | |
|-------------------------|-----------------------|----------|---------|---------|----------------|--------|-----------------|--|--|
| S-Klasse (W221) (06-13) | S 350 | 3) Coull | 12.2005 | | 03.0655-0007.2 | 370007 | DISTANCE SENSOR | 9G433311077 , 6804 6475AA , 9M68-2M113-AA , C2C 39935 , 163 540 12 17 , 30665607 | |
| | | 3) Coull | | 05.2013 | 03.0655-0007.2 | 370007 | DISTANCE SENSOR | 9G433311077 , 6804 6475AA , 9M68-2M113-AA , C2C 39935 , 163 540 12 17 , 30665607 | |
| | S 350 4-matic | 3) Coull | 02.2007 | | 03.0655-0007.2 | 370007 | DISTANCE SENSOR | 9G433311077 , 6804 6475AA , 9M68-2M113-AA , C2C 39935 , 163 540 12 17 , 30665607 | |
| | | 3) Coull | | 05.2013 | 03.0655-0007.2 | 370007 | DISTANCE SENSOR | 9G433311077 , 6804 6475AA , 9M68-2M113-AA , C2C 39935 , 163 540 12 17 , 30665607 | |
| | S 350 BlueTec | 3) Coull | 04.2011 | 05.2013 | 03.0655-0007.2 | 370007 | DISTANCE SENSOR | 9G433311077 , 6804 6475AA , 9M68-2M113-AA , C2C 39935 , 163 540 12 17 , 30665607 | |
| | S 350 BlueTec 4-matic | 3) Coull | 04.2011 | 05.2013 | 03.0655-0007.2 | 370007 | DISTANCE SENSOR | 9G433311077 , 6804 6475AA , 9M68-2M113-AA , C2C 39935 , 163 540 12 17 , 30665607 | |
| | S 350 CGI | 3) Coull | 04.2011 | 05.2013 | 03.0655-0007.2 | 370007 | DISTANCE SENSOR | 9G433311077 , 6804 6475AA , 9M68-2M113-AA , C2C 39935 , 163 540 12 17 , 30665607 | |
| | S 350 CGI 4-matic | 3) Coull | 04.2011 | 05.2013 | 03.0655-0007.2 | 370007 | DISTANCE SENSOR | 9G433311077 , 6804 6475AA , 9M68-2M113-AA , C2C 39935 , 163 540 12 17 , 30665607 | |
| | S 400 Hybrid | 3) Coull | 06.2009 | 05.2013 | 03.0655-0007.2 | 370007 | DISTANCE SENSOR | 9G433311077 , 6804 6475AA , 9M68-2M113-AA , C2C 39935 , 163 540 12 17 , 30665607 | |



| | | | | | | | |
|--|--|--|--|--|--------------------|---|--------------------------------------|
| | | | | | Bezeichnung | OE-Nummern zu ATE Artikelnummern | z.B. Vorsachnummern / diverse |
|--|--|--|--|--|--------------------|---|--------------------------------------|

MERCEDES BENZ

| | | | | | | | | | |
|-------------------------|-----------------------|----------|---------|---------|----------------|--------|-----------------|--|--|
| S-Klasse (W221) (06-13) | S 420 CDI / S 450 CDI | 3) Coull | 04.2006 | | 03.0655-0007.2 | 370007 | DISTANCE SENSOR | 9G433311077 , 6804 6475AA , 9M68-2M113-AA , C2C 39935 , 163 540 12 17 , 30665607 | |
| | | 3) Coull | | 05.2013 | 03.0655-0007.2 | 370007 | DISTANCE SENSOR | 9G433311077 , 6804 6475AA , 9M68-2M113-AA , C2C 39935 , 163 540 12 17 , 30665607 | |
| | S 450 | 3) Coull | | 05.2013 | 03.0655-0007.2 | 370007 | DISTANCE SENSOR | 9G433311077 , 6804 6475AA , 9M68-2M113-AA , C2C 39935 , 163 540 12 17 , 30665607 | |
| | | 3) Coull | 04.2006 | | 03.0655-0007.2 | 370007 | DISTANCE SENSOR | 9G433311077 , 6804 6475AA , 9M68-2M113-AA , C2C 39935 , 163 540 12 17 , 30665607 | |
| | S 450 4-matic | 3) Coull | 04.2006 | | 03.0655-0007.2 | 370007 | DISTANCE SENSOR | 9G433311077 , 6804 6475AA , 9M68-2M113-AA , C2C 39935 , 163 540 12 17 , 30665607 | |
| | | 3) Coull | | 05.2013 | 03.0655-0007.2 | 370007 | DISTANCE SENSOR | 9G433311077 , 6804 6475AA , 9M68-2M113-AA , C2C 39935 , 163 540 12 17 , 30665607 | |
| | S 500 | 3) Coull | 12.2005 | | 03.0655-0007.2 | 370007 | DISTANCE SENSOR | 9G433311077 , 6804 6475AA , 9M68-2M113-AA , C2C 39935 , 163 540 12 17 , 30665607 | |
| | | 3) Coull | | 05.2013 | 03.0655-0007.2 | 370007 | DISTANCE SENSOR | 9G433311077 , 6804 6475AA , 9M68-2M113-AA , C2C 39935 , 163 540 12 17 , 30665607 | |
| | S 500 4-matic | 3) Coull | 04.2006 | | 03.0655-0007.2 | 370007 | DISTANCE SENSOR | 9G433311077 , 6804 6475AA , 9M68-2M113-AA , C2C 39935 , 163 540 12 17 , 30665607 | |



| | | | | | | | |
|--|--|--|--|--|--------------------|---|--------------------------------------|
| | | | | | Bezeichnung | OE-Nummern zu ATE Artikelnummern | z.B. Vorsachnummern / diverse |
|--|--|--|--|--|--------------------|---|--------------------------------------|

MERCEDES BENZ

| | | | | | | | | | |
|-------------------------|-------------------|----------|---------|---------|----------------|--------|-----------------|--|--|
| S-Klasse (W221) (06-13) | S 500 4-matic | 3) Coull | | 05.2013 | 03.0655-0007.2 | 370007 | DISTANCE SENSOR | 9G433311077 , 6804 6475AA , 9M68-2M113-AA , C2C 39935 , 163 540 12 17 , 30665607 | |
| | S 500 CGI | 3) Coull | 04.2011 | 05.2013 | 03.0655-0007.2 | 370007 | DISTANCE SENSOR | 9G433311077 , 6804 6475AA , 9M68-2M113-AA , C2C 39935 , 163 540 12 17 , 30665607 | |
| | S 500 CGI 4-matic | 3) Coull | 03.2011 | 05.2013 | 03.0655-0007.2 | 370007 | DISTANCE SENSOR | 9G433311077 , 6804 6475AA , 9M68-2M113-AA , C2C 39935 , 163 540 12 17 , 30665607 | |
| | S 600 | 3) Coull | 12.2005 | 05.2013 | 03.0655-0007.2 | 370007 | DISTANCE SENSOR | 9G433311077 , 6804 6475AA , 9M68-2M113-AA , C2C 39935 , 163 540 12 17 , 30665607 | |
| | | 3) Coull | | 05.2013 | 03.0655-0007.2 | 370007 | DISTANCE SENSOR | 9G433311077 , 6804 6475AA , 9M68-2M113-AA , C2C 39935 , 163 540 12 17 , 30665607 | |
| | | 3) Coull | 12.2005 | | 03.0655-0007.2 | 370007 | DISTANCE SENSOR | 9G433311077 , 6804 6475AA , 9M68-2M113-AA , C2C 39935 , 163 540 12 17 , 30665607 | |
| | S 63 AMG | 3) Coull | 01.2007 | | 03.0655-0007.2 | 370007 | DISTANCE SENSOR | 9G433311077 , 6804 6475AA , 9M68-2M113-AA , C2C 39935 , 163 540 12 17 , 30665607 | |
| | | 3) Coull | | 05.2013 | 03.0655-0007.2 | 370007 | DISTANCE SENSOR | 9G433311077 , 6804 6475AA , 9M68-2M113-AA , C2C 39935 , 163 540 12 17 , 30665607 | |
| | | 3) Coull | 01.2007 | 05.2013 | 03.0655-0007.2 | 370007 | DISTANCE SENSOR | 9G433311077 , 6804 6475AA , 9M68-2M113-AA , C2C 39935 , 163 540 12 17 , 30665607 | |



Bezeichnung

OE-Nummern
zu ATE
Artikelnummern



z.B. Vorsachnummern /
diverse

MERCEDES BENZ

| | | | | | | | | | |
|---------------------------|--------------------|----------|---------|---------|----------------|--------|-----------------|--|--|
| S-Klasse (W221) (06-13) | S 65 AMG | 3) Coull | 04.2006 | | 03.0655-0007.2 | 370007 | DISTANCE SENSOR | 9G433311077 , 6804 6475AA , 9M68-2M113-AA , C2C 39935 , 163 540 12 17 , 30665607 | |
| | | 3) Coull | | 05.2013 | 03.0655-0007.2 | 370007 | DISTANCE SENSOR | 9G433311077 , 6804 6475AA , 9M68-2M113-AA , C2C 39935 , 163 540 12 17 , 30665607 | |
| | | 3) Coull | 04.2006 | 05.2013 | 03.0655-0007.2 | 370007 | DISTANCE SENSOR | 9G433311077 , 6804 6475AA , 9M68-2M113-AA , C2C 39935 , 163 540 12 17 , 30665607 | |
| SLK-Klasse (R170) (96-04) | SLK 200 Kompressor | 3) Coull | 03.2000 | 03.2004 | 03.0655-0007.2 | 370007 | DISTANCE SENSOR | 9G433311077 , 6804 6475AA , 9M68-2M113-AA , C2C 39935 , 163 540 12 17 , 30665607 | |
| | SLK 230 Kompressor | 3) Coull | 03.2000 | 03.2004 | 03.0655-0007.2 | 370007 | DISTANCE SENSOR | 9G433311077 , 6804 6475AA , 9M68-2M113-AA , C2C 39935 , 163 540 12 17 , 30665607 | |
| | SLK 32 AMG | 3) Coull | 03.2001 | 03.2004 | 03.0655-0007.2 | 370007 | DISTANCE SENSOR | 9G433311077 , 6804 6475AA , 9M68-2M113-AA , C2C 39935 , 163 540 12 17 , 30665607 | |
| | SLK 320 | 3) Coull | 04.2000 | 03.2004 | 03.0655-0007.2 | 370007 | DISTANCE SENSOR | 9G433311077 , 6804 6475AA , 9M68-2M113-AA , C2C 39935 , 163 540 12 17 , 30665607 | |
| SLK-Klasse (R171) (04-11) | SLK 200 Kompressor | 3) Coull | 01.2008 | | 03.0655-0007.2 | 370007 | DISTANCE SENSOR | 9G433311077 , 6804 6475AA , 9M68-2M113-AA , C2C 39935 , 163 540 12 17 , 30665607 | |
| | | 3) Coull | 03.2004 | | 03.0655-0007.2 | 370007 | DISTANCE SENSOR | 9G433311077 , 6804 6475AA , 9M68-2M113-AA , C2C 39935 , 163 540 12 17 , 30665607 | |



| | | | | | | | |
|--|--|--|--|--|--------------------|---|--------------------------------------|
| | | | | | Bezeichnung | OE-Nummern zu ATE Artikelnummern | z.B. Vorsachnummern / diverse |
|--|--|--|--|--|--------------------|---|--------------------------------------|

MERCEDES BENZ

| | | | | | | | | |
|---------------------------|--------------------|----------|---------|---------|----------------|--------|-----------------|--|
| SLK-Klasse (R171) (04-11) | SLK 200 Kompressor | 3) Coull | | 01.2011 | 03.0655-0007.2 | 370007 | DISTANCE SENSOR | 9G433311077 , 6804 6475AA , 9M68-2M113-AA , C2C 39935 , 163 540 12 17 , 30665607 |
| | SLK 280 | 3) Coull | 04.2005 | | 03.0655-0007.2 | 370007 | DISTANCE SENSOR | 9G433311077 , 6804 6475AA , 9M68-2M113-AA , C2C 39935 , 163 540 12 17 , 30665607 |
| | | 3) Coull | | 01.2011 | 03.0655-0007.2 | 370007 | DISTANCE SENSOR | 9G433311077 , 6804 6475AA , 9M68-2M113-AA , C2C 39935 , 163 540 12 17 , 30665607 |
| | SLK 300 | 3) Coull | 03.2009 | | 03.0655-0007.2 | 370007 | DISTANCE SENSOR | 9G433311077 , 6804 6475AA , 9M68-2M113-AA , C2C 39935 , 163 540 12 17 , 30665607 |
| | | 3) Coull | | 01.2011 | 03.0655-0007.2 | 370007 | DISTANCE SENSOR | 9G433311077 , 6804 6475AA , 9M68-2M113-AA , C2C 39935 , 163 540 12 17 , 30665607 |
| | SLK 350 | 3) Coull | | 01.2011 | 03.0655-0007.2 | 370007 | DISTANCE SENSOR | 9G433311077 , 6804 6475AA , 9M68-2M113-AA , C2C 39935 , 163 540 12 17 , 30665607 |
| | | 3) Coull | 01.2008 | | 03.0655-0007.2 | 370007 | DISTANCE SENSOR | 9G433311077 , 6804 6475AA , 9M68-2M113-AA , C2C 39935 , 163 540 12 17 , 30665607 |
| | | 3) Coull | 03.2004 | | 03.0655-0007.2 | 370007 | DISTANCE SENSOR | 9G433311077 , 6804 6475AA , 9M68-2M113-AA , C2C 39935 , 163 540 12 17 , 30665607 |
| | SLK 55 AMG | 3) Coull | 03.2004 | | 03.0655-0007.2 | 370007 | DISTANCE SENSOR | 9G433311077 , 6804 6475AA , 9M68-2M113-AA , C2C 39935 , 163 540 12 17 , 30665607 |



| | | | | | | |
|--|--|--|--|--------------------|---|--|
| | | | | Bezeichnung | OE-Nummern zu ATE Artikelnummern | z.B. Vorsachnummern / diverse |
|--|--|--|--|--------------------|---|--|

MERCEDES BENZ

| | | | | | | | | |
|---------------------------|------------|---------|---------|----------------|--------|-----------------|---|--|
| SLK-Klasse (R171) (04-11) | SLK 55 AMG | 3) Coup | 01.2011 | 03.0655-0007.2 | 370007 | DISTANCE SENSOR | 9G433311077 , 6804 6475AA , 9M68-2M113-AA , C2C 39935 , 163 540 12 17 , 30665607 | |
|---------------------------|------------|---------|---------|----------------|--------|-----------------|---|--|







| | | | | | | | |
|--|--|--|--|--|--------------------|---|--------------------------------------|
| | | | | | Bezeichnung | OE-Nummern zu ATE Artikelnummern | z.B. Vorsachnummern / diverse |
|--|--|--|--|--|--------------------|---|--------------------------------------|

MITSUBISHI

| | | | | | | | | | |
|---|----------------------|----------|---------|--|----------------|--------|--------------|---------------------|--|
| LANCER Evolution (CZ4A) (07-) | 2,0 i 16V | 3) Coupl | 06.2009 | | 24.0110-0345.1 | 410345 | BREMSSCHEIBE | 4615A119 , MN116332 | |
| LANCER Sportback (CX_A) (08-) | 1,5 16V (CX2A) | 3) Coupl | 06.2008 | | 24.0110-0345.1 | 410345 | BREMSSCHEIBE | 4615A119 , MN116332 | |
| | 1,6 16V (CX1A) | 3) Coupl | 05.2010 | | 24.0110-0345.1 | 410345 | BREMSSCHEIBE | 4615A119 , MN116332 | |
| | 1,8 16V (CX3A) | 3) Coupl | 03.2009 | | 24.0110-0345.1 | 410345 | BREMSSCHEIBE | 4615A119 , MN116332 | |
| | | 3) Coupl | 06.2008 | | 24.0110-0345.1 | 410345 | BREMSSCHEIBE | 4615A119 , MN116332 | |
| | 1,8 16V Flex (CX3A) | 3) Coupl | 03.2009 | | 24.0110-0345.1 | 410345 | BREMSSCHEIBE | 4615A119 , MN116332 | |
| | 1,8 DI-D (CX9A) | 3) Coupl | 05.2010 | | 24.0110-0345.1 | 410345 | BREMSSCHEIBE | 4615A119 , MN116332 | |
| | | 3) Coupl | 06.2010 | | 24.0110-0345.1 | 410345 | BREMSSCHEIBE | 4615A119 , MN116332 | |
| | 2,0 DI-D (CX8A) | 3) Coupl | 06.2008 | | 24.0110-0345.1 | 410345 | BREMSSCHEIBE | 4615A119 , MN116332 | |
| LANCER Stufenheck/Sportlimousine (CY_A) (07-) | 1,5 16V (CY2A) | 3) Coupl | 06.2008 | | 24.0110-0345.1 | 410345 | BREMSSCHEIBE | 4615A119 , MN116332 | |
| | 1,6 16V ((CY1A) | 3) Coupl | 05.2010 | | 24.0110-0345.1 | 410345 | BREMSSCHEIBE | 4615A119 , MN116332 | |
| | 1,8 16V (CY3A) | 3) Coupl | 02.2008 | | 24.0110-0345.1 | 410345 | BREMSSCHEIBE | 4615A119 , MN116332 | |
| | | 3) Coupl | 05.2010 | | 24.0110-0345.1 | 410345 | BREMSSCHEIBE | 4615A119 , MN116332 | |
| | 1,8 16V Flex (CY3A) | 3) Coupl | 03.2009 | | 24.0110-0345.1 | 410345 | BREMSSCHEIBE | 4615A119 , MN116332 | |
| | 1,8 DI-D (CY9A) | 3) Coupl | 06.2010 | | 24.0110-0345.1 | 410345 | BREMSSCHEIBE | 4615A119 , MN116332 | |
| | | 3) Coupl | 05.2010 | | 24.0110-0345.1 | 410345 | BREMSSCHEIBE | 4615A119 , MN116332 | |
| | 2,0 16V (CY4A) | 3) Coupl | 01.2009 | | 24.0110-0345.1 | 410345 | BREMSSCHEIBE | 4615A119 , MN116332 | |
| | | 3) Coupl | 10.2007 | | 24.0110-0345.1 | 410345 | BREMSSCHEIBE | 4615A119 , MN116332 | |
| | 2,0 16V Turbo (CY4A) | 3) Coupl | 10.2008 | | 24.0110-0345.1 | 410345 | BREMSSCHEIBE | 4615A119 , MN116332 | |
| | 2,0 DI-D (CY8A) | 3) Coupl | 01.2008 | | 24.0110-0345.1 | 410345 | BREMSSCHEIBE | 4615A119 , MN116332 | |



| | | | | | | | |
|---|---|---|--|---|--------------------|---|---|
|  |  |  |  |  | Bezeichnung | OE-Nummern zu ATE Artikelnummern |  z.B. Vorsachnummern / diverse |
|---|---|---|--|---|--------------------|---|---|

NISSAN

| | | | | | | | | | |
|---------------------|-----------|---------|---------|---------|----------------|--------|-------------|---------------------------|--|
| PIXO (K10B) (09-13) | 1,0 i 12V | 3) Coup | 06.2009 | 04.2013 | 24.3219-1765.3 | 020547 | RADZYLINDER | 44100-4A00D , 53402M68K00 | |
|---------------------|-----------|---------|---------|---------|----------------|--------|-------------|---------------------------|--|



Bezeichnung

OE-Nummern
zu ATE
Artikelnummern



z.B. Vorsachnummern /
diverse

PEUGEOT

| | | | | | | | | | |
|-----------------------|-----------------|----|---------|---------|----------------|--------|-------------|-------------------|--|
| 208 (12-) | 1,0 VTi | VR | 01.2012 | | 11.9571-9940.2 | 220924 | FAUSTSATTEL | 4400 W2 , 4400 X2 | |
| | 1,2 VTi | VR | 01.2012 | | 11.9571-9940.2 | 220924 | FAUSTSATTEL | 4400 W2 , 4400 X2 | |
| | 1,4 HDi | VR | 01.2012 | | 11.9571-9940.2 | 220924 | FAUSTSATTEL | 4400 W2 , 4400 X2 | |
| | 1,4 VTi | VR | 01.2012 | | 11.9571-9940.2 | 220924 | FAUSTSATTEL | 4400 W2 , 4400 X2 | |
| | 1,6 e-HDi | VR | 01.2012 | | 11.9571-9940.2 | 220924 | FAUSTSATTEL | 4400 W2 , 4400 X2 | |
| | 1,6 THP | VR | 01.2012 | | 11.9571-9940.2 | 220924 | FAUSTSATTEL | 4400 W2 , 4400 X2 | |
| | 1,6 VTi | VR | 01.2012 | | 11.9571-9940.2 | 220924 | FAUSTSATTEL | 4400 W2 , 4400 X2 | |
| 3008 (09-) | 1,6 THP | VR | 06.2009 | | 11.9571-9940.2 | 220924 | FAUSTSATTEL | 4400 W2 , 4400 X2 | |
| | 2,0 HDi | VR | 06.2009 | | 11.9571-9940.2 | 220924 | FAUSTSATTEL | 4400 W2 , 4400 X2 | |
| | | VR | 09.2011 | | 11.9571-9940.2 | 220924 | FAUSTSATTEL | 4400 W2 , 4400 X2 | |
| 308 CC (09-) | 1,6 16V | VR | 06.2009 | | 11.9571-9940.2 | 220924 | FAUSTSATTEL | 4400 W2 , 4400 X2 | |
| | | VR | 09.2009 | | 11.9571-9940.2 | 220924 | FAUSTSATTEL | 4400 W2 , 4400 X2 | |
| | 1,6 THP | VR | 06.2009 | | 11.9571-9940.2 | 220924 | FAUSTSATTEL | 4400 W2 , 4400 X2 | |
| | 2,0 HDi | VR | 04.2009 | | 11.9571-9940.2 | 220924 | FAUSTSATTEL | 4400 W2 , 4400 X2 | |
| | | VR | 06.2009 | | 11.9571-9940.2 | 220924 | FAUSTSATTEL | 4400 W2 , 4400 X2 | |
| | 2,0 HDi FAP 140 | VR | 03.2009 | | 11.9571-9940.2 | 220924 | FAUSTSATTEL | 4400 W2 , 4400 X2 | |
| 308 Limousine (07-13) | 1,6 16V | VR | 10.2009 | 07.2013 | 11.9571-9940.2 | 220924 | FAUSTSATTEL | 4400 W2 , 4400 X2 | |
| | 1,6 175 THP | VR | | 07.2013 | 11.9571-9940.2 | 220924 | FAUSTSATTEL | 4400 W2 , 4400 X2 | |
| | 2,0 HDi 135 | VR | | | 11.9571-9940.2 | 220924 | FAUSTSATTEL | 4400 W2 , 4400 X2 | |
| | 2,0 HDi 163 | VR | 04.2012 | 07.2013 | 11.9571-9940.2 | 220924 | FAUSTSATTEL | 4400 W2 , 4400 X2 | |
| 308 SW (08-) | 1,6 16V | VR | | | 11.9571-9940.2 | 220924 | FAUSTSATTEL | 4400 W2 , 4400 X2 | |



| | | | | | | | |
|--|----------|--|--|--|--------------------|---|--|
| | i | | | | Bezeichnung | OE-Nummern zu ATE Artikelnummern | i z.B. Vorsachnummern / diverse |
|--|----------|--|--|--|--------------------|---|--|

PEUGEOT

| | | | | | | | | | |
|--------------|-------------|----|---------|--|----------------|--------|-------------|-------------------|--|
| 308 SW (08-) | 1,6 16V | VR | 10.2009 | | 11.9571-9940.2 | 220924 | FAUSTSATTEL | 4400 W2 , 4400 X2 | |
| | 2,0 BioFlex | VR | | | 11.9571-9940.2 | 220924 | FAUSTSATTEL | 4400 W2 , 4400 X2 | |
| | 2,0 HDi | VR | 06.2009 | | 11.9571-9940.2 | 220924 | FAUSTSATTEL | 4400 W2 , 4400 X2 | |
| | 2,0 HDi 135 | VR | | | 11.9571-9940.2 | 220924 | FAUSTSATTEL | 4400 W2 , 4400 X2 | |
| | 2,0 HDi 140 | VR | 12.2008 | | 11.9571-9940.2 | 220924 | FAUSTSATTEL | 4400 W2 , 4400 X2 | |
| | 2,0 HDi 150 | VR | 04.2011 | | 11.9571-9940.2 | 220924 | FAUSTSATTEL | 4400 W2 , 4400 X2 | |
| RCZ (10-) | 1,6 16V | VR | 03.2010 | | 11.9571-9940.2 | 220924 | FAUSTSATTEL | 4400 W2 , 4400 X2 | |
| | 2,0 HDi | VR | 03.2010 | | 11.9571-9940.2 | 220924 | FAUSTSATTEL | 4400 W2 , 4400 X2 | |







| | | | | | | | |
|--|--|--|--|--|--------------------|---|--------------------------------------|
| | | | | | Bezeichnung | OE-Nummern zu ATE Artikelnummern | z.B. Vorsachnummern / diverse |
|--|--|--|--|--|--------------------|---|--------------------------------------|

RENAULT

| | | | | | | | | | |
|-----------------------------------|---------|----------|---------|---------|----------------|--------|-----------------|--|---------|
| GRAND SCENIC (JZ_) (09-) | 1,2 TCe | 3) Coull | 03.2012 | | 13.0460-2757.2 | 602757 | BELAGSATZ | 44 06 014 16R , 44 06 046 94R | s. Abb. |
| | | 3) Coull | 03.2013 | | 13.0460-2757.2 | 602757 | BELAGSATZ | 44 06 014 16R , 44 06 046 94R | s. Abb. |
| | 1,4 16V | 3) Coull | 02.2009 | | 13.0460-2757.2 | 602757 | BELAGSATZ | 44 06 014 16R , 44 06 046 94R | s. Abb. |
| | 1,5 dCi | 3) Coull | 02.2009 | | 13.0460-2757.2 | 602757 | BELAGSATZ | 44 06 014 16R , 44 06 046 94R | s. Abb. |
| | | 3) Coull | 04.2009 | | 13.0460-2757.2 | 602757 | BELAGSATZ | 44 06 014 16R , 44 06 046 94R | s. Abb. |
| | | 3) Coull | 11.2010 | | 13.0460-2757.2 | 602757 | BELAGSATZ | 44 06 014 16R , 44 06 046 94R | s. Abb. |
| | 1,6 16V | 3) Coull | 02.2009 | | 13.0460-2757.2 | 602757 | BELAGSATZ | 44 06 014 16R , 44 06 046 94R | s. Abb. |
| | 1,6 dCi | 3) Coull | 04.2011 | | 13.0460-2757.2 | 602757 | BELAGSATZ | 44 06 014 16R , 44 06 046 94R | s. Abb. |
| | 1,9 dCi | 3) Coull | 02.2009 | | 13.0460-2757.2 | 602757 | BELAGSATZ | 44 06 014 16R , 44 06 046 94R | s. Abb. |
| | 2,0 16V | 3) Coull | 02.2009 | | 13.0460-2757.2 | 602757 | BELAGSATZ | 44 06 014 16R , 44 06 046 94R | s. Abb. |
| | 2,0 dCi | 3) Coull | 04.2009 | | 13.0460-2757.2 | 602757 | BELAGSATZ | 44 06 014 16R , 44 06 046 94R | s. Abb. |
| | | 3) Coull | 02.2009 | | 13.0460-2757.2 | 602757 | BELAGSATZ | 44 06 014 16R , 44 06 046 94R | s. Abb. |
| LAGUNA II Grandtour (KG_) (01-07) | 1,6 16V | 3) Coull | 03.2001 | 05.2001 | 03.0655-0007.2 | 370007 | DISTANCE SENSOR | 9G433311077 , 6804 6475AA , 9M68-2M113-AA , C2C 39935 , 163 540 12 17 , 30665607 | |



| | | | | | | | |
|---|----------|---|--|---|--------------------|---|--|
|  | i |  |  |  | Bezeichnung | OE-Nummern zu ATE Artikelnummern | i z.B. Vorsachnummern / diverse |
|---|----------|---|--|---|--------------------|---|--|

RENAULT

| | | | | | | | | | |
|-----------------------------------|--------------------|----------|---------|---------|----------------|--------|-----------------|--|--|
| LAGUNA II Grandtour (KG_) (01-07) | 1,6 16V | 3) Coull | 03.2001 | 06.2007 | 03.0655-0007.2 | 370007 | DISTANCE SENSOR | 9G433311077 , 6804 6475AA , 9M68-2M113-AA , C2C 39935 , 163 540 12 17 , 30665607 | |
| | 1,6 FlexFuel | 3) Coull | 06.2001 | 10.2003 | 03.0655-0007.2 | 370007 | DISTANCE SENSOR | 9G433311077 , 6804 6475AA , 9M68-2M113-AA , C2C 39935 , 163 540 12 17 , 30665607 | |
| | 1,8 16V (O4/O6/OV) | 3) Coull | 03.2001 | 05.2001 | 03.0655-0007.2 | 370007 | DISTANCE SENSOR | 9G433311077 , 6804 6475AA , 9M68-2M113-AA , C2C 39935 , 163 540 12 17 , 30665607 | |
| | | 3) Coull | 03.2001 | 06.2007 | 03.0655-0007.2 | 370007 | DISTANCE SENSOR | 9G433311077 , 6804 6475AA , 9M68-2M113-AA , C2C 39935 , 163 540 12 17 , 30665607 | |
| | 1,8 16V (OB/OC/OM) | 3) Coull | 03.2001 | 05.2001 | 03.0655-0007.2 | 370007 | DISTANCE SENSOR | 9G433311077 , 6804 6475AA , 9M68-2M113-AA , C2C 39935 , 163 540 12 17 , 30665607 | |
| | | 3) Coull | 03.2001 | 06.2007 | 03.0655-0007.2 | 370007 | DISTANCE SENSOR | 9G433311077 , 6804 6475AA , 9M68-2M113-AA , C2C 39935 , 163 540 12 17 , 30665607 | |
| | 1,8 16V (OJ) | 3) Coull | 03.2001 | 06.2007 | 03.0655-0007.2 | 370007 | DISTANCE SENSOR | 9G433311077 , 6804 6475AA , 9M68-2M113-AA , C2C 39935 , 163 540 12 17 , 30665607 | |
| | | 3) Coull | 03.2001 | 05.2001 | 03.0655-0007.2 | 370007 | DISTANCE SENSOR | 9G433311077 , 6804 6475AA , 9M68-2M113-AA , C2C 39935 , 163 540 12 17 , 30665607 | |
| | 1,9 dCi | 3) Coull | 05.2005 | 06.2007 | 03.0655-0007.2 | 370007 | DISTANCE SENSOR | 9G433311077 , 6804 6475AA , 9M68-2M113-AA , C2C 39935 , 163 540 12 17 , 30665607 | |



| | | | | | | | |
|--|--|--|--|--|-------------|--|--------------------------------------|
| | | | | | Bezeichnung | OE-Nummern zu ATE Artikelnummern | z.B. Vorsachnummern / diverse |
|--|--|--|--|--|-------------|--|--------------------------------------|

RENAULT

| | | | | | | | | |
|-----------------------------------|--------------------|----------|---------|---------|----------------|--------|-----------------|--|
| LAGUNA II Grandtour (KG_) (01-07) | 1,9 dCi | 3) Coull | 03.2001 | 06.2007 | 03.0655-0007.2 | 370007 | DISTANCE SENSOR | 9G433311077 , 6804 6475AA , 9M68-2M113-AA , C2C 39935 , 163 540 12 17 , 30665607 |
| | | 3) Coull | 01.2005 | 06.2007 | 03.0655-0007.2 | 370007 | DISTANCE SENSOR | 9G433311077 , 6804 6475AA , 9M68-2M113-AA , C2C 39935 , 163 540 12 17 , 30665607 |
| | 1,9 dCi (08/10) | 3) Coull | 03.2004 | 06.2007 | 03.0655-0007.2 | 370007 | DISTANCE SENSOR | 9G433311077 , 6804 6475AA , 9M68-2M113-AA , C2C 39935 , 163 540 12 17 , 30665607 |
| | 1,9 dCi (OE) | 3) Coull | 06.2001 | 06.2007 | 03.0655-0007.2 | 370007 | DISTANCE SENSOR | 9G433311077 , 6804 6475AA , 9M68-2M113-AA , C2C 39935 , 163 540 12 17 , 30665607 |
| | 1,9 dCi (OG) | 3) Coull | 03.2001 | 05.2001 | 03.0655-0007.2 | 370007 | DISTANCE SENSOR | 9G433311077 , 6804 6475AA , 9M68-2M113-AA , C2C 39935 , 163 540 12 17 , 30665607 |
| | | 3) Coull | 06.2001 | 06.2007 | 03.0655-0007.2 | 370007 | DISTANCE SENSOR | 9G433311077 , 6804 6475AA , 9M68-2M113-AA , C2C 39935 , 163 540 12 17 , 30665607 |
| | 1,9 dCi (OR) | 3) Coull | 10.2001 | 06.2007 | 03.0655-0007.2 | 370007 | DISTANCE SENSOR | 9G433311077 , 6804 6475AA , 9M68-2M113-AA , C2C 39935 , 163 540 12 17 , 30665607 |
| | 2,0 16V | 3) Coull | 01.2005 | 06.2007 | 03.0655-0007.2 | 370007 | DISTANCE SENSOR | 9G433311077 , 6804 6475AA , 9M68-2M113-AA , C2C 39935 , 163 540 12 17 , 30665607 |
| | 2,0 16V (OO/OK/OW) | 3) Coull | 08.2002 | 06.2007 | 03.0655-0007.2 | 370007 | DISTANCE SENSOR | 9G433311077 , 6804 6475AA , 9M68-2M113-AA , C2C 39935 , 163 540 12 17 , 30665607 |



Bezeichnung

OE-Nummern
zu ATE
Artikelnummern



z.B. Vorsachnummern /
diverse

RENAULT

| LAGUNA II Grandtour (KG_) (01-07) | 2,0 16V IDE (ON/OP) | 3) Coull | 04.2001 | 06.2007 | 03.0655-0007.2 | 370007 | DISTANCE SENSOR | 9G433311077 , 6804 6475AA , 9M68-2M113-AA , C2C 39935 , 163 540 12 17 , 30665607 |
|-----------------------------------|---------------------|----------|---------|---------|----------------|--------|-----------------|--|
| | | 3) Coull | 04.2001 | 05.2001 | 03.0655-0007.2 | 370007 | DISTANCE SENSOR | 9G433311077 , 6804 6475AA , 9M68-2M113-AA , C2C 39935 , 163 540 12 17 , 30665607 |
| | 2,0 16V Sport | 3) Coull | 01.2005 | 06.2007 | 03.0655-0007.2 | 370007 | DISTANCE SENSOR | 9G433311077 , 6804 6475AA , 9M68-2M113-AA , C2C 39935 , 163 540 12 17 , 30665607 |
| | 2,0 16V Turbo | 3) Coull | 01.2003 | 06.2007 | 03.0655-0007.2 | 370007 | DISTANCE SENSOR | 9G433311077 , 6804 6475AA , 9M68-2M113-AA , C2C 39935 , 163 540 12 17 , 30665607 |
| | 2,0 dCi | 3) Coull | 08.2005 | 06.2007 | 03.0655-0007.2 | 370007 | DISTANCE SENSOR | 9G433311077 , 6804 6475AA , 9M68-2M113-AA , C2C 39935 , 163 540 12 17 , 30665607 |
| | 2,0 dCi 130 | 3) Coull | 01.2006 | 06.2007 | 03.0655-0007.2 | 370007 | DISTANCE SENSOR | 9G433311077 , 6804 6475AA , 9M68-2M113-AA , C2C 39935 , 163 540 12 17 , 30665607 |
| | 2,2 dCi | 3) Coull | 10.2001 | 06.2007 | 03.0655-0007.2 | 370007 | DISTANCE SENSOR | 9G433311077 , 6804 6475AA , 9M68-2M113-AA , C2C 39935 , 163 540 12 17 , 30665607 |
| | | 3) Coull | 05.2005 | 06.2007 | 03.0655-0007.2 | 370007 | DISTANCE SENSOR | 9G433311077 , 6804 6475AA , 9M68-2M113-AA , C2C 39935 , 163 540 12 17 , 30665607 |
| | 3,0 V6 | 3) Coull | 03.2001 | 06.2007 | 03.0655-0007.2 | 370007 | DISTANCE SENSOR | 9G433311077 , 6804 6475AA , 9M68-2M113-AA , C2C 39935 , 163 540 12 17 , 30665607 |



Bezeichnung

OE-Nummern
zu ATE
Artikelnummern







z.B. Vorsachnummern /
diverse

RENAULT

| Model | Engine | Body | Start | End | ATE Part No. | ATE Ref. No. | Description | OE Numbers | Notes |
|-----------------------------------|--------------------|---------|---------|---------|----------------|--------------|-----------------|--|-------|
| LAGUNA II Grandtour (KG_) (01-07) | 3,0 V6 | 3) Coup | 03.2001 | 05.2001 | 03.0655-0007.2 | 370007 | DISTANCE SENSOR | 9G433311077 , 6804 6475AA , 9M68-2M113-AA , C2C 39935 , 163 540 12 17 , 30665607 | |
| LAGUNA II Limousine (BG_) (01-07) | 1,6 16V | 3) Coup | 02.2005 | 06.2007 | 03.0655-0007.2 | 370007 | DISTANCE SENSOR | 9G433311077 , 6804 6475AA , 9M68-2M113-AA , C2C 39935 , 163 540 12 17 , 30665607 | |
| | | 3) Coup | 03.2001 | 05.2001 | 03.0655-0007.2 | 370007 | DISTANCE SENSOR | 9G433311077 , 6804 6475AA , 9M68-2M113-AA , C2C 39935 , 163 540 12 17 , 30665607 | |
| | | 3) Coup | 03.2001 | 06.2007 | 03.0655-0007.2 | 370007 | DISTANCE SENSOR | 9G433311077 , 6804 6475AA , 9M68-2M113-AA , C2C 39935 , 163 540 12 17 , 30665607 | |
| | 1,8 16V (O4/O6/OV) | 3) Coup | 03.2001 | 06.2007 | 03.0655-0007.2 | 370007 | DISTANCE SENSOR | 9G433311077 , 6804 6475AA , 9M68-2M113-AA , C2C 39935 , 163 540 12 17 , 30665607 | |
| | | 3) Coup | 03.2001 | 05.2001 | 03.0655-0007.2 | 370007 | DISTANCE SENSOR | 9G433311077 , 6804 6475AA , 9M68-2M113-AA , C2C 39935 , 163 540 12 17 , 30665607 | |
| | 1,8 16V (OB/OC/OM) | 3) Coup | 03.2001 | 06.2007 | 03.0655-0007.2 | 370007 | DISTANCE SENSOR | 9G433311077 , 6804 6475AA , 9M68-2M113-AA , C2C 39935 , 163 540 12 17 , 30665607 | |
| | | 3) Coup | 03.2001 | 05.2001 | 03.0655-0007.2 | 370007 | DISTANCE SENSOR | 9G433311077 , 6804 6475AA , 9M68-2M113-AA , C2C 39935 , 163 540 12 17 , 30665607 | |
| | 1,8 16V (OJ) | 3) Coup | 03.2001 | 05.2001 | 03.0655-0007.2 | 370007 | DISTANCE SENSOR | 9G433311077 , 6804 6475AA , 9M68-2M113-AA , C2C 39935 , 163 540 12 17 , 30665607 | |



| | | | | | | | |
|---|---|---|--|---|--------------------|---|---|
|  |  |  |  |  | Bezeichnung | OE-Nummern zu ATE Artikelnummern |  z.B. Vorsachnummern / diverse |
|---|---|---|--|---|--------------------|---|---|

RENAULT

| | | | | | | | | |
|-----------------------------------|-----------------|----------|---------|---------|----------------|--------|-----------------|--|
| LAGUNA II Limousine (BG_) (01-07) | 1,8 16V (0J) | 3) Coull | 03.2001 | 06.2007 | 03.0655-0007.2 | 370007 | DISTANCE SENSOR | 9G433311077 , 6804 6475AA , 9M68-2M113-AA , C2C 39935 , 163 540 12 17 , 30665607 |
| | 1,9 dCi | 3) Coull | 01.2005 | 06.2007 | 03.0655-0007.2 | 370007 | DISTANCE SENSOR | 9G433311077 , 6804 6475AA , 9M68-2M113-AA , C2C 39935 , 163 540 12 17 , 30665607 |
| | | 3) Coull | 05.2005 | 06.2007 | 03.0655-0007.2 | 370007 | DISTANCE SENSOR | 9G433311077 , 6804 6475AA , 9M68-2M113-AA , C2C 39935 , 163 540 12 17 , 30665607 |
| | | 3) Coull | 03.2001 | 06.2007 | 03.0655-0007.2 | 370007 | DISTANCE SENSOR | 9G433311077 , 6804 6475AA , 9M68-2M113-AA , C2C 39935 , 163 540 12 17 , 30665607 |
| | 1,9 dCi (08/10) | 3) Coull | 03.2004 | 06.2007 | 03.0655-0007.2 | 370007 | DISTANCE SENSOR | 9G433311077 , 6804 6475AA , 9M68-2M113-AA , C2C 39935 , 163 540 12 17 , 30665607 |
| | | 3) Coull | 03.2001 | 05.2001 | 03.0655-0007.2 | 370007 | DISTANCE SENSOR | 9G433311077 , 6804 6475AA , 9M68-2M113-AA , C2C 39935 , 163 540 12 17 , 30665607 |
| | 1,9 dCi (OE) | 3) Coull | 06.2001 | 06.2007 | 03.0655-0007.2 | 370007 | DISTANCE SENSOR | 9G433311077 , 6804 6475AA , 9M68-2M113-AA , C2C 39935 , 163 540 12 17 , 30665607 |
| | 1,9 dCi (OG) | 3) Coull | 03.2001 | 05.2001 | 03.0655-0007.2 | 370007 | DISTANCE SENSOR | 9G433311077 , 6804 6475AA , 9M68-2M113-AA , C2C 39935 , 163 540 12 17 , 30665607 |
| | | 3) Coull | 03.2001 | 06.2007 | 03.0655-0007.2 | 370007 | DISTANCE SENSOR | 9G433311077 , 6804 6475AA , 9M68-2M113-AA , C2C 39935 , 163 540 12 17 , 30665607 |



| | | | | | | | |
|--|----------|--|--|--|--------------------|---|--|
| | i | | | | Bezeichnung | OE-Nummern zu ATE Artikelnummern | i z.B. Vorsachnummern / diverse |
|--|----------|--|--|--|--------------------|---|--|

RENAULT

| | | | | | | | | |
|-----------------------------------|---------------------|----------|---------|---------|----------------|--------|-----------------|--|
| LAGUNA II Limousine (BG_) (01-07) | 1,9 dCi (OR) | 3) Coull | 10.2001 | 06.2007 | 03.0655-0007.2 | 370007 | DISTANCE SENSOR | 9G433311077 , 6804 6475AA , 9M68-2M113-AA , C2C 39935 , 163 540 12 17 , 30665607 |
| | 2,0 16V | 3) Coull | 01.2005 | 06.2007 | 03.0655-0007.2 | 370007 | DISTANCE SENSOR | 9G433311077 , 6804 6475AA , 9M68-2M113-AA , C2C 39935 , 163 540 12 17 , 30665607 |
| | 2,0 16V (OO/OK/OW) | 3) Coull | 08.2002 | 06.2007 | 03.0655-0007.2 | 370007 | DISTANCE SENSOR | 9G433311077 , 6804 6475AA , 9M68-2M113-AA , C2C 39935 , 163 540 12 17 , 30665607 |
| | | 3) Coull | 04.2001 | 05.2001 | 03.0655-0007.2 | 370007 | DISTANCE SENSOR | 9G433311077 , 6804 6475AA , 9M68-2M113-AA , C2C 39935 , 163 540 12 17 , 30665607 |
| | 2,0 16V IDE (ON/OP) | 3) Coull | 04.2001 | 06.2007 | 03.0655-0007.2 | 370007 | DISTANCE SENSOR | 9G433311077 , 6804 6475AA , 9M68-2M113-AA , C2C 39935 , 163 540 12 17 , 30665607 |
| | | 3) Coull | 04.2001 | 05.2001 | 03.0655-0007.2 | 370007 | DISTANCE SENSOR | 9G433311077 , 6804 6475AA , 9M68-2M113-AA , C2C 39935 , 163 540 12 17 , 30665607 |
| | 2,0 16V Sport | 3) Coull | 01.2005 | 06.2007 | 03.0655-0007.2 | 370007 | DISTANCE SENSOR | 9G433311077 , 6804 6475AA , 9M68-2M113-AA , C2C 39935 , 163 540 12 17 , 30665607 |
| | 2,0 16V Turbo | 3) Coull | 01.2003 | 06.2007 | 03.0655-0007.2 | 370007 | DISTANCE SENSOR | 9G433311077 , 6804 6475AA , 9M68-2M113-AA , C2C 39935 , 163 540 12 17 , 30665607 |
| | 2,0 dCi | 3) Coull | 08.2005 | 06.2007 | 03.0655-0007.2 | 370007 | DISTANCE SENSOR | 9G433311077 , 6804 6475AA , 9M68-2M113-AA , C2C 39935 , 163 540 12 17 , 30665607 |







| | | | | | | | |
|--|----------|--|--|--|--------------------|---|--|
| | i | | | | Bezeichnung | OE-Nummern zu ATE Artikelnummern | i z.B. Vorsachnummern / diverse |
|--|----------|--|--|--|--------------------|---|--|

RENAULT

| | | | | | | | | | |
|-----------------------------------|--------------------|----------|---------|---------|----------------|--------|-----------------|--|---------|
| LAGUNA II Limousine (BG_) (01-07) | 2,0 dCi 130 | 3) Coull | 01.2006 | 06.2007 | 03.0655-0007.2 | 370007 | DISTANCE SENSOR | 9G433311077 , 6804 6475AA , 9M68-2M113-AA , C2C 39935 , 163 540 12 17 , 30665607 | |
| | 2,2 dCi | 3) Coull | 03.2001 | 05.2001 | 03.0655-0007.2 | 370007 | DISTANCE SENSOR | 9G433311077 , 6804 6475AA , 9M68-2M113-AA , C2C 39935 , 163 540 12 17 , 30665607 | |
| | | 3) Coull | 10.2001 | 06.2007 | 03.0655-0007.2 | 370007 | DISTANCE SENSOR | 9G433311077 , 6804 6475AA , 9M68-2M113-AA , C2C 39935 , 163 540 12 17 , 30665607 | |
| | | 3) Coull | 05.2005 | 06.2007 | 03.0655-0007.2 | 370007 | DISTANCE SENSOR | 9G433311077 , 6804 6475AA , 9M68-2M113-AA , C2C 39935 , 163 540 12 17 , 30665607 | |
| | 3,0 V6 | 3) Coull | 03.2001 | 05.2001 | 03.0655-0007.2 | 370007 | DISTANCE SENSOR | 9G433311077 , 6804 6475AA , 9M68-2M113-AA , C2C 39935 , 163 540 12 17 , 30665607 | |
| | | 3) Coull | 03.2001 | 06.2007 | 03.0655-0007.2 | 370007 | DISTANCE SENSOR | 9G433311077 , 6804 6475AA , 9M68-2M113-AA , C2C 39935 , 163 540 12 17 , 30665607 | |
| MEGANE III CC (EZ0_) (10-) | 1,2 TCe | 3) Coull | 04.2013 | | 13.0460-2756.2 | 602756 | BELAGSATZ | 44 06 037 34R , 44 06 046 94R | s. Abb. |
| | 1,4 16V | 3) Coull | 06.2010 | | 13.0460-2756.2 | 602756 | BELAGSATZ | 44 06 037 34R , 44 06 046 94R | s. Abb. |
| | 1,5 dCi | 3) Coull | 06.2010 | | 13.0460-2756.2 | 602756 | BELAGSATZ | 44 06 037 34R , 44 06 046 94R | s. Abb. |
| | 1,6 16V | 3) Coull | 06.2010 | | 13.0460-2756.2 | 602756 | BELAGSATZ | 44 06 037 34R , 44 06 046 94R | s. Abb. |
| | 1,6 16V Bio-Petrol | 3) Coull | 06.2010 | | 13.0460-2756.2 | 602756 | BELAGSATZ | 44 06 037 34R , 44 06 046 94R | s. Abb. |



| | | | | | | | |
|---|---|---|--|---|--------------------|---|---|
|  |  |  |  |  | Bezeichnung | OE-Nummern zu ATE Artikelnummern |  z.B. Vorsachnummern / diverse |
|---|---|---|--|---|--------------------|---|---|

RENAULT

| | | | | | | | | | |
|-------------------------------|----------------|----------|---------|--|----------------|--------|-----------|-------------------------------|---------|
| MEGANE III CC (EZ0_) (10-) | 1,6 dCi | 3) Coull | 04.2011 | | 13.0460-2756.2 | 602756 | BELAGSATZ | 44 06 037 34R , 44 06 046 94R | s. Abb. |
| | 1,9 dCi | 3) Coull | 06.2010 | | 13.0460-2756.2 | 602756 | BELAGSATZ | 44 06 037 34R , 44 06 046 94R | s. Abb. |
| | 2,0 16V | 3) Coull | 06.2010 | | 13.0460-2756.2 | 602756 | BELAGSATZ | 44 06 037 34R , 44 06 046 94R | s. Abb. |
| | 2,0 dCi | 3) Coull | 06.2010 | | 13.0460-2756.2 | 602756 | BELAGSATZ | 44 06 037 34R , 44 06 046 94R | s. Abb. |
| | 2,0 TCe | 3) Coull | 06.2010 | | 13.0460-2756.2 | 602756 | BELAGSATZ | 44 06 037 34R , 44 06 046 94R | s. Abb. |
| MEGANE III Coupe (DZ0_) (08-) | 1,2 TCe | 3) Coull | 03.2012 | | 13.0460-2756.2 | 602756 | BELAGSATZ | 44 06 037 34R , 44 06 046 94R | s. Abb. |
| | 1,4 16V | 3) Coull | 04.2009 | | 13.0460-2756.2 | 602756 | BELAGSATZ | 44 06 037 34R , 44 06 046 94R | s. Abb. |
| | 1,5 dCi | 3) Coull | 02.2009 | | 13.0460-2756.2 | 602756 | BELAGSATZ | 44 06 037 34R , 44 06 046 94R | s. Abb. |
| | | 3) Coull | 11.2008 | | 13.0460-2756.2 | 602756 | BELAGSATZ | 44 06 037 34R , 44 06 046 94R | s. Abb. |
| | 1,6 16V | 3) Coull | 11.2008 | | 13.0460-2756.2 | 602756 | BELAGSATZ | 44 06 037 34R , 44 06 046 94R | s. Abb. |
| | 1,6 16V Bifuel | 3) Coull | 11.2008 | | 13.0460-2756.2 | 602756 | BELAGSATZ | 44 06 037 34R , 44 06 046 94R | s. Abb. |
| | 1,9 dCi | 3) Coull | 11.2008 | | 13.0460-2756.2 | 602756 | BELAGSATZ | 44 06 037 34R , 44 06 046 94R | s. Abb. |
| | 2,0 16V | 3) Coull | 05.2009 | | 13.0460-2756.2 | 602756 | BELAGSATZ | 44 06 037 34R , 44 06 046 94R | s. Abb. |
| | 2,0 dCi | 3) Coull | 04.2009 | | 13.0460-2756.2 | 602756 | BELAGSATZ | 44 06 037 34R , 44 06 046 94R | s. Abb. |



| | | | | | | | |
|--|----------|--|--|--|--------------------|---|--|
| | i | | | | Bezeichnung | OE-Nummern zu ATE Artikelnummern | i z.B. Vorsachnummern / diverse |
|--|----------|--|--|--|--------------------|---|--|

RENAULT

| | | | | | | | | | |
|----------------------------------|----------------|----------|---------|--|----------------|--------|-----------|-------------------------------|---------|
| MEGANE III Coupe (DZ0_) (08-) | 2,0 TCe | 3) Coull | 06.2012 | | 13.0460-2756.2 | 602756 | BELAGSATZ | 44 06 037 34R , 44 06 046 94R | s. Abb. |
| | | 3) Coull | 11.2008 | | 13.0460-2756.2 | 602756 | BELAGSATZ | 44 06 037 34R , 44 06 046 94R | s. Abb. |
| | 2,0 TCe 220 | 3) Coull | 11.2013 | | 13.0460-2756.2 | 602756 | BELAGSATZ | 44 06 037 34R , 44 06 046 94R | s. Abb. |
| MEGANE III Grandtour (KZ_) (08-) | 1,2 TCe | 3) Coull | 03.2012 | | 13.0460-2756.2 | 602756 | BELAGSATZ | 44 06 037 34R , 44 06 046 94R | s. Abb. |
| | 1,4 16V | 3) Coull | 05.2009 | | 13.0460-2756.2 | 602756 | BELAGSATZ | 44 06 037 34R , 44 06 046 94R | s. Abb. |
| | 1,5 dCi | 3) Coull | 05.2009 | | 13.0460-2756.2 | 602756 | BELAGSATZ | 44 06 037 34R , 44 06 046 94R | s. Abb. |
| | | 3) Coull | 08.2009 | | 13.0460-2756.2 | 602756 | BELAGSATZ | 44 06 037 34R , 44 06 046 94R | s. Abb. |
| | | 3) Coull | 02.2009 | | 13.0460-2756.2 | 602756 | BELAGSATZ | 44 06 037 34R , 44 06 046 94R | s. Abb. |
| | | 3) Coull | 11.2013 | | 13.0460-2756.2 | 602756 | BELAGSATZ | 44 06 037 34R , 44 06 046 94R | s. Abb. |
| | 1,6 16V | 3) Coull | 05.2009 | | 13.0460-2756.2 | 602756 | BELAGSATZ | 44 06 037 34R , 44 06 046 94R | s. Abb. |
| | 1,6 16V Bifuel | 3) Coull | 11.2008 | | 13.0460-2756.2 | 602756 | BELAGSATZ | 44 06 037 34R , 44 06 046 94R | s. Abb. |
| | 1,9 dCi | 3) Coull | 05.2009 | | 13.0460-2756.2 | 602756 | BELAGSATZ | 44 06 037 34R , 44 06 046 94R | s. Abb. |
| | 2,0 16V | 3) Coull | 05.2009 | | 13.0460-2756.2 | 602756 | BELAGSATZ | 44 06 037 34R , 44 06 046 94R | s. Abb. |
| | 2,0 dCi | 3) Coull | 08.2009 | | 13.0460-2756.2 | 602756 | BELAGSATZ | 44 06 037 34R , 44 06 046 94R | s. Abb. |



| | | | | | | | |
|--|--|--|--|--|--------------------|---|--------------------------------------|
| | | | | | Bezeichnung | OE-Nummern zu ATE Artikelnummern | z.B. Vorsachnummern / diverse |
|--|--|--|--|--|--------------------|---|--------------------------------------|

RENAULT

| | | | | | | | | | |
|------------------------------------|----------------|----------|---------|--|----------------|--------|-----------|-------------------------------|---------|
| MEGANE III Grandtour (KZ_) (08-) | 2,0 dCi | 3) Coull | 07.2012 | | 13.0460-2756.2 | 602756 | BELAGSATZ | 44 06 037 34R , 44 06 046 94R | s. Abb. |
| | | 3) Coull | 04.2009 | | 13.0460-2756.2 | 602756 | BELAGSATZ | 44 06 037 34R , 44 06 046 94R | s. Abb. |
| | 2,0 TCe | 3) Coull | 05.2009 | | 13.0460-2756.2 | 602756 | BELAGSATZ | 44 06 037 34R , 44 06 046 94R | s. Abb. |
| | | 3) Coull | 09.2012 | | 13.0460-2756.2 | 602756 | BELAGSATZ | 44 06 037 34R , 44 06 046 94R | s. Abb. |
| MEGANE III Schrögheck (BZ0_) (08-) | 1,2 TCe | 3) Coull | 01.2013 | | 13.0460-2756.2 | 602756 | BELAGSATZ | 44 06 037 34R , 44 06 046 94R | s. Abb. |
| | | 3) Coull | 03.2012 | | 13.0460-2756.2 | 602756 | BELAGSATZ | 44 06 037 34R , 44 06 046 94R | s. Abb. |
| | 1,4 | 3) Coull | 04.2009 | | 13.0460-2756.2 | 602756 | BELAGSATZ | 44 06 037 34R , 44 06 046 94R | s. Abb. |
| | 1,5 dCi | 3) Coull | 11.2013 | | 13.0460-2756.2 | 602756 | BELAGSATZ | 44 06 037 34R , 44 06 046 94R | s. Abb. |
| | | 3) Coull | 12.2009 | | 13.0460-2756.2 | 602756 | BELAGSATZ | 44 06 037 34R , 44 06 046 94R | s. Abb. |
| | | 3) Coull | 11.2008 | | 13.0460-2756.2 | 602756 | BELAGSATZ | 44 06 037 34R , 44 06 046 94R | s. Abb. |
| | | 3) Coull | 02.2009 | | 13.0460-2756.2 | 602756 | BELAGSATZ | 44 06 037 34R , 44 06 046 94R | s. Abb. |
| | 1,6 | 3) Coull | 11.2008 | | 13.0460-2756.2 | 602756 | BELAGSATZ | 44 06 037 34R , 44 06 046 94R | s. Abb. |
| | 1,6 16V Bifuel | 3) Coull | 11.2008 | | 13.0460-2756.2 | 602756 | BELAGSATZ | 44 06 037 34R , 44 06 046 94R | s. Abb. |
| | 1,9 dCi | 3) Coull | 11.2008 | | 13.0460-2756.2 | 602756 | BELAGSATZ | 44 06 037 34R , 44 06 046 94R | s. Abb. |



| | | | | | | | |
|--|--|--|--|--|--------------------|---|--------------------------------------|
| | | | | | Bezeichnung | OE-Nummern zu ATE Artikelnummern | z.B. Vorsachnummern / diverse |
|--|--|--|--|--|--------------------|---|--------------------------------------|

RENAULT

| | | | | | | | | | |
|------------------------------------|-------------|----------|---------|--|----------------|--------|-----------|-------------------------------|---------|
| MEGANE III Schrägheck (BZ0_) (08-) | 2 | 3) Coull | 02.2009 | | 13.0460-2756.2 | 602756 | BELAGSATZ | 44 06 037 34R , 44 06 046 94R | s. Abb. |
| | 2,0 dCi | 3) Coull | 04.2009 | | 13.0460-2756.2 | 602756 | BELAGSATZ | 44 06 037 34R , 44 06 046 94R | s. Abb. |
| | | 3) Coull | 10.2010 | | 13.0460-2756.2 | 602756 | BELAGSATZ | 44 06 037 34R , 44 06 046 94R | s. Abb. |
| | 2,0 TCe | 3) Coull | 11.2008 | | 13.0460-2756.2 | 602756 | BELAGSATZ | 44 06 037 34R , 44 06 046 94R | s. Abb. |
| | | 3) Coull | 06.2012 | | 13.0460-2756.2 | 602756 | BELAGSATZ | 44 06 037 34R , 44 06 046 94R | s. Abb. |
| | 2,0 TCe 220 | 3) Coull | 11.2013 | | 13.0460-2756.2 | 602756 | BELAGSATZ | 44 06 037 34R , 44 06 046 94R | s. Abb. |
| SCENIC III (JZ_) (09-) | 1,2 TCe | 3) Coull | 03.2013 | | 13.0460-2757.2 | 602757 | BELAGSATZ | 44 06 014 16R , 44 06 046 94R | s. Abb. |
| | | 3) Coull | 03.2012 | | 13.0460-2757.2 | 602757 | BELAGSATZ | 44 06 014 16R , 44 06 046 94R | s. Abb. |
| | | 3) Coull | 03.2012 | | 13.0460-2756.2 | 602756 | BELAGSATZ | 44 06 037 34R , 44 06 046 94R | s. Abb. |
| | | 3) Coull | 03.2013 | | 13.0460-2756.2 | 602756 | BELAGSATZ | 44 06 037 34R , 44 06 046 94R | s. Abb. |
| | 1,4 TCe | 3) Coull | 04.2009 | | 13.0460-2756.2 | 602756 | BELAGSATZ | 44 06 037 34R , 44 06 046 94R | s. Abb. |
| | | 3) Coull | 04.2009 | | 13.0460-2757.2 | 602757 | BELAGSATZ | 44 06 014 16R , 44 06 046 94R | s. Abb. |
| | 1,5 dCi | 3) Coull | 04.2009 | | 13.0460-2757.2 | 602757 | BELAGSATZ | 44 06 014 16R , 44 06 046 94R | s. Abb. |
| | | 3) Coull | 11.2010 | | 13.0460-2757.2 | 602757 | BELAGSATZ | 44 06 014 16R , 44 06 046 94R | s. Abb. |



| | | | | | | | |
|--|--|--|--|--|--------------------|---|--------------------------------------|
| | | | | | Bezeichnung | OE-Nummern zu ATE Artikelnummern | z.B. Vorsachnummern / diverse |
|--|--|--|--|--|--------------------|---|--------------------------------------|

RENAULT

| | | | | | | | | | |
|------------------------|---------|----------|---------|--|----------------|--------|-----------|-------------------------------|---------|
| SCENIC III (JZ_) (09-) | 1,5 dCi | 3) Coull | 11.2010 | | 13.0460-2756.2 | 602756 | BELAGSATZ | 44 06 037 34R , 44 06 046 94R | s. Abb. |
| | | 3) Coull | 04.2009 | | 13.0460-2756.2 | 602756 | BELAGSATZ | 44 06 037 34R , 44 06 046 94R | s. Abb. |
| | 1,6 16V | 3) Coull | 04.2009 | | 13.0460-2756.2 | 602756 | BELAGSATZ | 44 06 037 34R , 44 06 046 94R | s. Abb. |
| | | 3) Coull | 04.2009 | | 13.0460-2757.2 | 602757 | BELAGSATZ | 44 06 014 16R , 44 06 046 94R | s. Abb. |
| | 1,6 dCi | 3) Coull | 04.2011 | | 13.0460-2756.2 | 602756 | BELAGSATZ | 44 06 037 34R , 44 06 046 94R | s. Abb. |
| | | 3) Coull | 04.2011 | | 13.0460-2757.2 | 602757 | BELAGSATZ | 44 06 014 16R , 44 06 046 94R | s. Abb. |
| | 1,6 E85 | 3) Coull | 06.2009 | | 13.0460-2757.2 | 602757 | BELAGSATZ | 44 06 014 16R , 44 06 046 94R | s. Abb. |
| | | 3) Coull | 06.2009 | | 13.0460-2756.2 | 602756 | BELAGSATZ | 44 06 037 34R , 44 06 046 94R | s. Abb. |
| | 1,9 dCi | 3) Coull | 04.2009 | | 13.0460-2757.2 | 602757 | BELAGSATZ | 44 06 014 16R , 44 06 046 94R | s. Abb. |
| | | 3) Coull | 04.2009 | | 13.0460-2756.2 | 602756 | BELAGSATZ | 44 06 037 34R , 44 06 046 94R | s. Abb. |
| | 2,0 16V | 3) Coull | 04.2009 | | 13.0460-2757.2 | 602757 | BELAGSATZ | 44 06 014 16R , 44 06 046 94R | s. Abb. |
| | | 3) Coull | 04.2009 | | 13.0460-2756.2 | 602756 | BELAGSATZ | 44 06 037 34R , 44 06 046 94R | s. Abb. |
| | 2,0 dCi | 3) Coull | 04.2009 | | 13.0460-2757.2 | 602757 | BELAGSATZ | 44 06 014 16R , 44 06 046 94R | s. Abb. |
| | | 3) Coull | 04.2009 | | 13.0460-2756.2 | 602756 | BELAGSATZ | 44 06 037 34R , 44 06 046 94R | s. Abb. |



| | | | | | | | |
|--|----------|--|--|--|--------------------|---|--|
| | i | | | | Bezeichnung | OE-Nummern zu ATE Artikelnummern | i z.B. Vorsachnummern / diverse |
|--|----------|--|--|--|--------------------|---|--|

SEAT

| | | | | | | | | | |
|----------------------|-----------------|----------|---------|---------|----------------|--------|----------------|--|----------------|
| ALHAMBRA I (96-10) | 1,8 T 20V | 3) Coupl | 05.1998 | | 24.5166-0454.3 | 331306 | BREMSSCHLAUCH | 1001348 , 95VW-2078-AE , 7335771 , 7M0 611 701 D | 83.7717-0450.3 |
| | 1,9 TDI | 3) Coupl | 06.2000 | | 24.5166-0454.3 | 331306 | BREMSSCHLAUCH | 1001348 , 95VW-2078-AE , 7335771 , 7M0 611 701 D | 83.7717-0450.3 |
| | | 3) Coupl | 11.2002 | | 24.5166-0454.3 | 331306 | BREMSSCHLAUCH | 1001348 , 95VW-2078-AE , 7335771 , 7M0 611 701 D | 83.7717-0450.3 |
| | | 3) Coupl | 03.1996 | | 24.5166-0454.3 | 331306 | BREMSSCHLAUCH | 1001348 , 95VW-2078-AE , 7335771 , 7M0 611 701 D | 83.7717-0450.3 |
| | | 3) Coupl | 10.1997 | 05.2000 | 24.5166-0454.3 | 331306 | BREMSSCHLAUCH | 1001348 , 95VW-2078-AE , 7335771 , 7M0 611 701 D | 83.7717-0450.3 |
| | 1,9 TDI 4motion | 3) Coupl | 06.2005 | | 24.5166-0454.3 | 331306 | BREMSSCHLAUCH | 1001348 , 95VW-2078-AE , 7335771 , 7M0 611 701 D | 83.7717-0450.3 |
| | 2,0 i | 3) Coupl | 03.1996 | | 24.5166-0454.3 | 331306 | BREMSSCHLAUCH | 1001348 , 95VW-2078-AE , 7335771 , 7M0 611 701 D | 83.7717-0450.3 |
| ALTEA (5P1) (04-) | 1,6 i 16V | 3) Coupl | 01.2007 | | 24.2519-1706.3 | 040096 | NEHMERZYLINDER | 6Q0 721 261 F , 6Q0 721 261 D , 6QE 721 261 , 5Q0 721 261 , 1U0 721 261 A , 6Q0 721 261 A | |
| | 1,6 LPG | 3) Coupl | 09.2009 | | 24.2519-1706.3 | 040096 | NEHMERZYLINDER | 6Q0 721 261 F , 6Q0 721 261 D , 6QE 721 261 , 5Q0 721 261 , 1U0 721 261 A , 6Q0 721 261 A | |
| ALTEA XL (5P5) (06-) | 1,6 i 16V | 3) Coupl | 01.2007 | | 24.2519-1706.3 | 040096 | NEHMERZYLINDER | 6Q0 721 261 F , 6Q0 721 261 D , 6QE 721 261 , 5Q0 721 261 , 1U0 721 261 A , 6Q0 721 261 A | |
| | 1,6 LPG | 3) Coupl | 09.2009 | | 24.2519-1706.3 | 040096 | NEHMERZYLINDER | 6Q0 721 261 F , 6Q0 721 261 D , 6QE 721 261 , 5Q0 721 261 , 1U0 721 261 A , 6Q0 721 261 A | |



| | | | | | | |
|--|----------|--|--|--------------------|---|--|
| | i | | | Bezeichnung | OE-Nummern zu ATE Artikelnummern | i z.B. Vorsachnummern / diverse |
|--|----------|--|--|--------------------|---|--|

SEAT

| | | | | | | | | | |
|---------------------------------|---------------|---------|---------|--|----------------|--------|----------------|---|--|
| IBIZA V / ST / SPORTCOUPE (08-) | 1,2 | 3) Coup | 07.2008 | | 24.2519-1706.3 | 040096 | NEHMERZYLINDER | 6Q0 721 261 F , 6Q0 721 261 D , 6QE 721 261 , 5Q0 721 261 , 1U0 721 261 A , 6Q0 721 261 A | |
| | | 3) Coup | 07.2009 | | 24.2519-1706.3 | 040096 | NEHMERZYLINDER | 6Q0 721 261 F , 6Q0 721 261 D , 6QE 721 261 , 5Q0 721 261 , 1U0 721 261 A , 6Q0 721 261 A | |
| | 1,2 TDI | 3) Coup | 04.2010 | | 24.2519-1706.3 | 040096 | NEHMERZYLINDER | 6Q0 721 261 F , 6Q0 721 261 D , 6QE 721 261 , 5Q0 721 261 , 1U0 721 261 A , 6Q0 721 261 A | |
| | 1,2 TSI | 3) Coup | 08.2012 | | 24.2519-1706.3 | 040096 | NEHMERZYLINDER | 6Q0 721 261 F , 6Q0 721 261 D , 6QE 721 261 , 5Q0 721 261 , 1U0 721 261 A , 6Q0 721 261 A | |
| | | 3) Coup | 09.2010 | | 24.2519-1706.3 | 040096 | NEHMERZYLINDER | 6Q0 721 261 F , 6Q0 721 261 D , 6QE 721 261 , 5Q0 721 261 , 1U0 721 261 A , 6Q0 721 261 A | |
| | 1,4 i 16V | 3) Coup | 07.2008 | | 24.2519-1706.3 | 040096 | NEHMERZYLINDER | 6Q0 721 261 F , 6Q0 721 261 D , 6QE 721 261 , 5Q0 721 261 , 1U0 721 261 A , 6Q0 721 261 A | |
| | 1,4 TDI | 3) Coup | 07.2008 | | 24.2519-1706.3 | 040096 | NEHMERZYLINDER | 6Q0 721 261 F , 6Q0 721 261 D , 6QE 721 261 , 5Q0 721 261 , 1U0 721 261 A , 6Q0 721 261 A | |
| | 1,4 TSI Cupra | 3) Coup | 06.2009 | | 24.2519-1706.3 | 040096 | NEHMERZYLINDER | 6Q0 721 261 F , 6Q0 721 261 D , 6QE 721 261 , 5Q0 721 261 , 1U0 721 261 A , 6Q0 721 261 A | |
| | 1,4 TSI FR | 3) Coup | 06.2009 | | 24.2519-1706.3 | 040096 | NEHMERZYLINDER | 6Q0 721 261 F , 6Q0 721 261 D , 6QE 721 261 , 5Q0 721 261 , 1U0 721 261 A , 6Q0 721 261 A | |



Bezeichnung

OE-Nummern
zu ATE
Artikelnummern







z.B. Vorsachnummern /
diverse

SEAT

| | | | | | | | | | |
|---------------------------------|------------|----------|---------|---------|----------------|--------|----------------|--|--|
| IBIZA V / ST / SPORTCOUPE (08-) | 1,4 TSI FR | 3) Coull | 12.2013 | | 24.2519-1706.3 | 040096 | NEHMERZYLINDER | 6Q0 721 261 F, 6Q0 721 261 D, 6QE 721 261, 5Q0 721 261, 1U0 721 261 A, 6Q0 721 261 A | |
| | 1,6 i 16V | 3) Coull | 07.2008 | | 24.2519-1706.3 | 040096 | NEHMERZYLINDER | 6Q0 721 261 F, 6Q0 721 261 D, 6QE 721 261, 5Q0 721 261, 1U0 721 261 A, 6Q0 721 261 A | |
| | 1,6 LPG | 3) Coull | 05.2011 | | 24.2519-1706.3 | 040096 | NEHMERZYLINDER | 6Q0 721 261 F, 6Q0 721 261 D, 6QE 721 261, 5Q0 721 261, 1U0 721 261 A, 6Q0 721 261 A | |
| | 1,6 TDI | 3) Coull | 06.2009 | | 24.2519-1706.3 | 040096 | NEHMERZYLINDER | 6Q0 721 261 F, 6Q0 721 261 D, 6QE 721 261, 5Q0 721 261, 1U0 721 261 A, 6Q0 721 261 A | |
| | 1,9 TDI | 3) Coull | 07.2008 | | 24.2519-1706.3 | 040096 | NEHMERZYLINDER | 6Q0 721 261 F, 6Q0 721 261 D, 6QE 721 261, 5Q0 721 261, 1U0 721 261 A, 6Q0 721 261 A | |
| | 2 | 3) Coull | 10.2008 | | 24.2519-1706.3 | 040096 | NEHMERZYLINDER | 6Q0 721 261 F, 6Q0 721 261 D, 6QE 721 261, 5Q0 721 261, 1U0 721 261 A, 6Q0 721 261 A | |
| | 2,0 TDI | 3) Coull | 01.2010 | | 24.2519-1706.3 | 040096 | NEHMERZYLINDER | 6Q0 721 261 F, 6Q0 721 261 D, 6QE 721 261, 5Q0 721 261, 1U0 721 261 A, 6Q0 721 261 A | |
| LEON II (1P1) (05-12) | 1,8 T 20V | 3) Coull | 06.2007 | 10.2012 | 24.2519-1706.3 | 040096 | NEHMERZYLINDER | 6Q0 721 261 F, 6Q0 721 261 D, 6QE 721 261, 5Q0 721 261, 1U0 721 261 A, 6Q0 721 261 A | |
| | 2,0 i 16V | 3) Coull | 08.2005 | 10.2012 | 24.2519-1706.3 | 040096 | NEHMERZYLINDER | 6Q0 721 261 F, 6Q0 721 261 D, 6QE 721 261, 5Q0 721 261, 1U0 721 261 A, 6Q0 721 261 A | |





| | | | | | | | |
|---|----------|---|--|---|--------------------|---|--|
|  | i |  |  |  | Bezeichnung | OE-Nummern zu ATE Artikelnummern | i z.B. Vorsachnummern / diverse |
|---|----------|---|--|---|--------------------|---|--|

SEAT

| | | | | | | | | |
|-------------------------------|-----------|----------|---------|---------|----------------|--------|----------------|--|
| LEON II (1P1) (05-12) | 2,0 TDI | 3) Coull | 08.2005 | 10.2012 | 24.2519-1706.3 | 040096 | NEHMERZYLINDER | 6Q0 721 261 F, 6Q0 721 261 D, 6QE 721 261, 5Q0 721 261, 1U0 721 261 A, 6Q0 721 261 A |
| LEON III (5F) / SC / ST (12-) | 1,2 TSI | 3) Coull | 09.2012 | | 24.2519-1706.3 | 040096 | NEHMERZYLINDER | 6Q0 721 261 F, 6Q0 721 261 D, 6QE 721 261, 5Q0 721 261, 1U0 721 261 A, 6Q0 721 261 A |
| | 1,4 TGI | 3) Coull | 10.2013 | | 24.2519-1706.3 | 040096 | NEHMERZYLINDER | 6Q0 721 261 F, 6Q0 721 261 D, 6QE 721 261, 5Q0 721 261, 1U0 721 261 A, 6Q0 721 261 A |
| | 1,4 TSI | 3) Coull | 09.2012 | | 24.2519-1706.3 | 040096 | NEHMERZYLINDER | 6Q0 721 261 F, 6Q0 721 261 D, 6QE 721 261, 5Q0 721 261, 1U0 721 261 A, 6Q0 721 261 A |
| | 1,6 TDI | 3) Coull | 09.2012 | | 24.2519-1706.3 | 040096 | NEHMERZYLINDER | 6Q0 721 261 F, 6Q0 721 261 D, 6QE 721 261, 5Q0 721 261, 1U0 721 261 A, 6Q0 721 261 A |
| | | 3) Coull | 09.2013 | | 24.2519-1706.3 | 040096 | NEHMERZYLINDER | 6Q0 721 261 F, 6Q0 721 261 D, 6QE 721 261, 5Q0 721 261, 1U0 721 261 A, 6Q0 721 261 A |
| | 1,8 TFSI | 3) Coull | 09.2012 | | 24.2519-1706.3 | 040096 | NEHMERZYLINDER | 6Q0 721 261 F, 6Q0 721 261 D, 6QE 721 261, 5Q0 721 261, 1U0 721 261 A, 6Q0 721 261 A |
| | 2,0 Cupra | 3) Coull | 10.2013 | | 24.2519-1706.3 | 040096 | NEHMERZYLINDER | 6Q0 721 261 F, 6Q0 721 261 D, 6QE 721 261, 5Q0 721 261, 1U0 721 261 A, 6Q0 721 261 A |
| | 2,0 TDI | 3) Coull | 09.2012 | | 24.2519-1706.3 | 040096 | NEHMERZYLINDER | 6Q0 721 261 F, 6Q0 721 261 D, 6QE 721 261, 5Q0 721 261, 1U0 721 261 A, 6Q0 721 261 A |







| | | | | | | | |
|---|----------|---|--|---|--------------------|---|--|
|  | i |  |  |  | Bezeichnung | OE-Nummern zu ATE Artikelnummern | i z.B. Vorsachnummern / diverse |
|---|----------|---|--|---|--------------------|---|--|

SEAT

| | | | | | | | | |
|-------------------------------|-----------|----------|---------|---------|----------------|--------|----------------|---|
| LEON III (5F) / SC / ST (12-) | 2,0 TDI | 3) Coull | 05.2013 | | 24.2519-1706.3 | 040096 | NEHMERZYLINDER | 6Q0 721 261 F , 6Q0 721 261 D , 6QE 721 261 , 5Q0 721 261 , 1U0 721 261 A , 6Q0 721 261 A |
| TOLEDO III (5P2) (05-09) | 1,4 16V | 3) Coull | 05.2006 | 03.2009 | 24.2519-1706.3 | 040096 | NEHMERZYLINDER | 6Q0 721 261 F , 6Q0 721 261 D , 6QE 721 261 , 5Q0 721 261 , 1U0 721 261 A , 6Q0 721 261 A |
| | 1,6 i 16V | 3) Coull | 10.2004 | 03.2009 | 24.2519-1706.3 | 040096 | NEHMERZYLINDER | 6Q0 721 261 F , 6Q0 721 261 D , 6QE 721 261 , 5Q0 721 261 , 1U0 721 261 A , 6Q0 721 261 A |
| | 1,8 TFSI | 3) Coull | 01.2007 | 03.2009 | 24.2519-1706.3 | 040096 | NEHMERZYLINDER | 6Q0 721 261 F , 6Q0 721 261 D , 6QE 721 261 , 5Q0 721 261 , 1U0 721 261 A , 6Q0 721 261 A |
| | 1,9 TDI | 3) Coull | 10.2004 | 03.2009 | 24.2519-1706.3 | 040096 | NEHMERZYLINDER | 6Q0 721 261 F , 6Q0 721 261 D , 6QE 721 261 , 5Q0 721 261 , 1U0 721 261 A , 6Q0 721 261 A |
| | 2,0 FSI | 3) Coull | 10.2004 | 03.2009 | 24.2519-1706.3 | 040096 | NEHMERZYLINDER | 6Q0 721 261 F , 6Q0 721 261 D , 6QE 721 261 , 5Q0 721 261 , 1U0 721 261 A , 6Q0 721 261 A |
| | 2,0 TDI | 3) Coull | 01.2006 | 03.2009 | 24.2519-1706.3 | 040096 | NEHMERZYLINDER | 6Q0 721 261 F , 6Q0 721 261 D , 6QE 721 261 , 5Q0 721 261 , 1U0 721 261 A , 6Q0 721 261 A |
| | | 3) Coull | 10.2004 | 03.2009 | 24.2519-1706.3 | 040096 | NEHMERZYLINDER | 6Q0 721 261 F , 6Q0 721 261 D , 6QE 721 261 , 5Q0 721 261 , 1U0 721 261 A , 6Q0 721 261 A |
| | 2,0 TFSI | 3) Coull | 11.2005 | 03.2009 | 24.2519-1706.3 | 040096 | NEHMERZYLINDER | 6Q0 721 261 F , 6Q0 721 261 D , 6QE 721 261 , 5Q0 721 261 , 1U0 721 261 A , 6Q0 721 261 A |







| | | | | | | | |
|---|---|---|--|---|--------------------|---|---|
|  |  |  |  |  | Bezeichnung | OE-Nummern zu ATE Artikelnummern |  z.B. Vorsachnummern / diverse |
|---|---|---|--|---|--------------------|---|---|

SEAT

| | | | | | | | | | |
|-----------------------|---------|----------|---------|--|----------------|--------|----------------|---|--|
| TOLEDO IV (KG3) (12-) | 1,2 | 3) Coull | 07.2012 | | 24.2519-1706.3 | 040096 | NEHMERZYLINDER | 6Q0 721 261 F , 6Q0 721 261 D , 6QE 721 261 , 5Q0 721 261 , 1U0 721 261 A , 6Q0 721 261 A | |
| | 1,2 TSI | 3) Coull | 07.2012 | | 24.2519-1706.3 | 040096 | NEHMERZYLINDER | 6Q0 721 261 F , 6Q0 721 261 D , 6QE 721 261 , 5Q0 721 261 , 1U0 721 261 A , 6Q0 721 261 A | |
| | 1,4 TSI | 3) Coull | 07.2012 | | 24.2519-1706.3 | 040096 | NEHMERZYLINDER | 6Q0 721 261 F , 6Q0 721 261 D , 6QE 721 261 , 5Q0 721 261 , 1U0 721 261 A , 6Q0 721 261 A | |
| | 1,6 | 3) Coull | 07.2013 | | 24.2519-1706.3 | 040096 | NEHMERZYLINDER | 6Q0 721 261 F , 6Q0 721 261 D , 6QE 721 261 , 5Q0 721 261 , 1U0 721 261 A , 6Q0 721 261 A | |
| | 1,6 TDI | 3) Coull | 07.2012 | | 24.2519-1706.3 | 040096 | NEHMERZYLINDER | 6Q0 721 261 F , 6Q0 721 261 D , 6QE 721 261 , 5Q0 721 261 , 1U0 721 261 A , 6Q0 721 261 A | |



| | | | | | | | |
|---|----------|---|--|---|--------------------|---|--|
|  | i |  |  |  | Bezeichnung | OE-Nummern zu ATE Artikelnummern | i z.B. Vorsachnummern / diverse |
|---|----------|---|--|---|--------------------|---|--|

SKODA

| | | | | | | | | |
|----------------------|------------|----------|---------|---------|----------------|--------|----------------|--|
| FABIA I (6Y) (99-07) | 1,0 i | 3) Coull | 02.2000 | 08.2002 | 24.2519-1706.3 | 040096 | NEHMERZYLINDER | 6Q0 721 261 F, 6Q0 721 261 D, 6QE 721 261, 5Q0 721 261, 1U0 721 261 A, 6Q0 721 261 A |
| | 1,2 i | 3) Coull | 08.2002 | 12.2007 | 24.2519-1706.3 | 040096 | NEHMERZYLINDER | 6Q0 721 261 F, 6Q0 721 261 D, 6QE 721 261, 5Q0 721 261, 1U0 721 261 A, 6Q0 721 261 A |
| | 1,4 i | 3) Coull | 02.2000 | 12.2007 | 24.2519-1706.3 | 040096 | NEHMERZYLINDER | 6Q0 721 261 F, 6Q0 721 261 D, 6QE 721 261, 5Q0 721 261, 1U0 721 261 A, 6Q0 721 261 A |
| | 1,4 i 16V | 3) Coull | 10.1999 | 12.2007 | 24.2519-1706.3 | 040096 | NEHMERZYLINDER | 6Q0 721 261 F, 6Q0 721 261 D, 6QE 721 261, 5Q0 721 261, 1U0 721 261 A, 6Q0 721 261 A |
| | 1,4 TDI | 3) Coull | 04.2003 | 12.2007 | 24.2519-1706.3 | 040096 | NEHMERZYLINDER | 6Q0 721 261 F, 6Q0 721 261 D, 6QE 721 261, 5Q0 721 261, 1U0 721 261 A, 6Q0 721 261 A |
| | 1,9 SDI | 3) Coull | 12.1999 | 12.2007 | 24.2519-1706.3 | 040096 | NEHMERZYLINDER | 6Q0 721 261 F, 6Q0 721 261 D, 6QE 721 261, 5Q0 721 261, 1U0 721 261 A, 6Q0 721 261 A |
| | 1,9 TDI | 3) Coull | 02.2000 | 12.2007 | 24.2519-1706.3 | 040096 | NEHMERZYLINDER | 6Q0 721 261 F, 6Q0 721 261 D, 6QE 721 261, 5Q0 721 261, 1U0 721 261 A, 6Q0 721 261 A |
| | 2,0 i | 3) Coull | 12.1999 | 12.2007 | 24.2519-1706.3 | 040096 | NEHMERZYLINDER | 6Q0 721 261 F, 6Q0 721 261 D, 6QE 721 261, 5Q0 721 261, 1U0 721 261 A, 6Q0 721 261 A |
| | RS 1,9 TDI | 3) Coull | 09.2003 | 12.2007 | 24.2519-1706.3 | 040096 | NEHMERZYLINDER | 6Q0 721 261 F, 6Q0 721 261 D, 6QE 721 261, 5Q0 721 261, 1U0 721 261 A, 6Q0 721 261 A |



| | | | | | | | |
|--|----------|--|--|--|--------------------|---|--|
| | i | | | | Bezeichnung | OE-Nummern zu ATE Artikelnummern | i z.B. Vorsachnummern / diverse |
|--|----------|--|--|--|--------------------|---|--|

SKODA

| | | | | | | | | | |
|---------------------|------------|----------|---------|--|----------------|--------|----------------|---|--|
| FABIA II (5J) (07-) | 1,2 | 3) Coull | 03.2007 | | 24.2519-1706.3 | 040096 | NEHMERZYLINDER | 6Q0 721 261 F , 6Q0 721 261 D , 6QE 721 261 , 5Q0 721 261 , 1U0 721 261 A , 6Q0 721 261 A | |
| | 1,2 TDI | 3) Coull | 05.2010 | | 24.2519-1706.3 | 040096 | NEHMERZYLINDER | 6Q0 721 261 F , 6Q0 721 261 D , 6QE 721 261 , 5Q0 721 261 , 1U0 721 261 A , 6Q0 721 261 A | |
| | 1,2 TSI | 3) Coull | 03.2010 | | 24.2519-1706.3 | 040096 | NEHMERZYLINDER | 6Q0 721 261 F , 6Q0 721 261 D , 6QE 721 261 , 5Q0 721 261 , 1U0 721 261 A , 6Q0 721 261 A | |
| | 1,4 i 16V | 3) Coull | 03.2007 | | 24.2519-1706.3 | 040096 | NEHMERZYLINDER | 6Q0 721 261 F , 6Q0 721 261 D , 6QE 721 261 , 5Q0 721 261 , 1U0 721 261 A , 6Q0 721 261 A | |
| | 1,4 TDI | 3) Coull | 03.2007 | | 24.2519-1706.3 | 040096 | NEHMERZYLINDER | 6Q0 721 261 F , 6Q0 721 261 D , 6QE 721 261 , 5Q0 721 261 , 1U0 721 261 A , 6Q0 721 261 A | |
| | 1,4 TSI RS | 3) Coull | 05.2010 | | 24.2519-1706.3 | 040096 | NEHMERZYLINDER | 6Q0 721 261 F , 6Q0 721 261 D , 6QE 721 261 , 5Q0 721 261 , 1U0 721 261 A , 6Q0 721 261 A | |
| | 1,6 i 16V | 3) Coull | 03.2007 | | 24.2519-1706.3 | 040096 | NEHMERZYLINDER | 6Q0 721 261 F , 6Q0 721 261 D , 6QE 721 261 , 5Q0 721 261 , 1U0 721 261 A , 6Q0 721 261 A | |
| | 1,6 TDI | 3) Coull | 04.2010 | | 24.2519-1706.3 | 040096 | NEHMERZYLINDER | 6Q0 721 261 F , 6Q0 721 261 D , 6QE 721 261 , 5Q0 721 261 , 1U0 721 261 A , 6Q0 721 261 A | |
| | | 3) Coull | 03.2010 | | 24.2519-1706.3 | 040096 | NEHMERZYLINDER | 6Q0 721 261 F , 6Q0 721 261 D , 6QE 721 261 , 5Q0 721 261 , 1U0 721 261 A , 6Q0 721 261 A | |



| | | | | | | | |
|--|----------|--|--|--|--------------------|---|--|
| | i | | | | Bezeichnung | OE-Nummern zu ATE Artikelnummern | i z.B. Vorsachnummern / diverse |
|--|----------|--|--|--|--------------------|---|--|

SKODA

| | | | | | | | | |
|-------------------------|-----------|----------|---------|---------|----------------|--------|----------------|--|
| FABIA II (5J) (07-) | 1,9 TDI | 3) Coull | 03.2007 | | 24.2519-1706.3 | 040096 | NEHMERZYLINDER | 6Q0 721 261 F, 6Q0 721 261 D, 6QE 721 261, 5Q0 721 261, 1U0 721 261 A, 6Q0 721 261 A |
| OCTAVIA I (1U) (97-10) | 1,4 i | 3) Coull | 04.1999 | 06.2010 | 24.2519-1706.3 | 040096 | NEHMERZYLINDER | 6Q0 721 261 F, 6Q0 721 261 D, 6QE 721 261, 5Q0 721 261, 1U0 721 261 A, 6Q0 721 261 A |
| OCTAVIA II (1Z) (04-13) | 1,2 TSI | 3) Coull | 02.2010 | 01.2013 | 24.2519-1706.3 | 040096 | NEHMERZYLINDER | 6Q0 721 261 F, 6Q0 721 261 D, 6QE 721 261, 5Q0 721 261, 1U0 721 261 A, 6Q0 721 261 A |
| | 1,4 i 16V | 3) Coull | 06.2004 | 01.2013 | 24.2519-1706.3 | 040096 | NEHMERZYLINDER | 6Q0 721 261 F, 6Q0 721 261 D, 6QE 721 261, 5Q0 721 261, 1U0 721 261 A, 6Q0 721 261 A |
| | 1,4 TSI | 3) Coull | 11.2008 | 01.2013 | 24.2519-1706.3 | 040096 | NEHMERZYLINDER | 6Q0 721 261 F, 6Q0 721 261 D, 6QE 721 261, 5Q0 721 261, 1U0 721 261 A, 6Q0 721 261 A |
| | 1,6 | 3) Coull | 09.2009 | 01.2013 | 24.2519-1706.3 | 040096 | NEHMERZYLINDER | 6Q0 721 261 F, 6Q0 721 261 D, 6QE 721 261, 5Q0 721 261, 1U0 721 261 A, 6Q0 721 261 A |
| | 1,6 FSI | 3) Coull | 06.2004 | 01.2013 | 24.2519-1706.3 | 040096 | NEHMERZYLINDER | 6Q0 721 261 F, 6Q0 721 261 D, 6QE 721 261, 5Q0 721 261, 1U0 721 261 A, 6Q0 721 261 A |
| | 1,6 i 16V | 3) Coull | 06.2004 | 01.2013 | 24.2519-1706.3 | 040096 | NEHMERZYLINDER | 6Q0 721 261 F, 6Q0 721 261 D, 6QE 721 261, 5Q0 721 261, 1U0 721 261 A, 6Q0 721 261 A |
| | 1,6 TDI | 3) Coull | 06.2009 | 01.2013 | 24.2519-1706.3 | 040096 | NEHMERZYLINDER | 6Q0 721 261 F, 6Q0 721 261 D, 6QE 721 261, 5Q0 721 261, 1U0 721 261 A, 6Q0 721 261 A |



Bezeichnung

OE-Nummern
zu ATE
Artikelnummern





z.B. Vorsachnummern /
diverse

SKODA

| OCTAVIA II (1Z) (04-13) | 1,6 TDI 4x4 | 3) Coull | 06.2009 | 01.2013 | 24.2519-1706.3 | 040096 | NEHMERZYLINDER | 6Q0 721 261 F, 6Q0 721 261 D, 6QE 721 261, 5Q0 721 261, 1U0 721 261 A, 6Q0 721 261 A |
|-------------------------|-------------|----------|---------|---------|----------------|--------|----------------|--|
| | 1,8 TSI | 3) Coull | 06.2007 | 01.2013 | 24.2519-1706.3 | 040096 | NEHMERZYLINDER | 6Q0 721 261 F, 6Q0 721 261 D, 6QE 721 261, 5Q0 721 261, 1U0 721 261 A, 6Q0 721 261 A |
| | 1,8 TSI 4x4 | 3) Coull | 11.2008 | 01.2013 | 24.2519-1706.3 | 040096 | NEHMERZYLINDER | 6Q0 721 261 F, 6Q0 721 261 D, 6QE 721 261, 5Q0 721 261, 1U0 721 261 A, 6Q0 721 261 A |
| | 1,9 TDI | 3) Coull | 06.2004 | 01.2013 | 24.2519-1706.3 | 040096 | NEHMERZYLINDER | 6Q0 721 261 F, 6Q0 721 261 D, 6QE 721 261, 5Q0 721 261, 1U0 721 261 A, 6Q0 721 261 A |
| | 1,9 TDI 4x4 | 3) Coull | 11.2004 | 01.2013 | 24.2519-1706.3 | 040096 | NEHMERZYLINDER | 6Q0 721 261 F, 6Q0 721 261 D, 6QE 721 261, 5Q0 721 261, 1U0 721 261 A, 6Q0 721 261 A |
| | 2,0 FSI | 3) Coull | 11.2004 | 01.2013 | 24.2519-1706.3 | 040096 | NEHMERZYLINDER | 6Q0 721 261 F, 6Q0 721 261 D, 6QE 721 261, 5Q0 721 261, 1U0 721 261 A, 6Q0 721 261 A |
| | 2,0 FSI 4x4 | 3) Coull | 11.2004 | 01.2013 | 24.2519-1706.3 | 040096 | NEHMERZYLINDER | 6Q0 721 261 F, 6Q0 721 261 D, 6QE 721 261, 5Q0 721 261, 1U0 721 261 A, 6Q0 721 261 A |
| | 2,0 RS | 3) Coull | 10.2005 | 01.2013 | 24.2519-1706.3 | 040096 | NEHMERZYLINDER | 6Q0 721 261 F, 6Q0 721 261 D, 6QE 721 261, 5Q0 721 261, 1U0 721 261 A, 6Q0 721 261 A |
| | 2,0 TDI | 3) Coull | 03.2010 | 01.2013 | 24.2519-1706.3 | 040096 | NEHMERZYLINDER | 6Q0 721 261 F, 6Q0 721 261 D, 6QE 721 261, 5Q0 721 261, 1U0 721 261 A, 6Q0 721 261 A |





| | | | | | | | |
|---|---|---|--|---|--------------------|---|---|
|  |  |  |  |  | Bezeichnung | OE-Nummern zu ATE Artikelnummern |  z.B. Vorsachnummern / diverse |
|---|---|---|--|---|--------------------|---|---|

SKODA

| | | | | | | | | |
|-------------------------|-------------|----------|---------|---------|----------------|--------|----------------|--|
| OCTAVIA II (1Z) (04-13) | 2,0 TDI | 3) Coull | 06.2004 | 01.2013 | 24.2519-1706.3 | 040096 | NEHMERZYLINDER | 6Q0 721 261 F, 6Q0 721 261 D, 6QE 721 261, 5Q0 721 261, 1U0 721 261 A, 6Q0 721 261 A |
| | 2,0 TDI 4x4 | 3) Coull | 07.2006 | 01.2013 | 24.2519-1706.3 | 040096 | NEHMERZYLINDER | 6Q0 721 261 F, 6Q0 721 261 D, 6QE 721 261, 5Q0 721 261, 1U0 721 261 A, 6Q0 721 261 A |
| | | 3) Coull | 05.2011 | 01.2013 | 24.2519-1706.3 | 040096 | NEHMERZYLINDER | 6Q0 721 261 F, 6Q0 721 261 D, 6QE 721 261, 5Q0 721 261, 1U0 721 261 A, 6Q0 721 261 A |
| | 2,0 TDI RS | 3) Coull | 04.2006 | 01.2013 | 24.2519-1706.3 | 040096 | NEHMERZYLINDER | 6Q0 721 261 F, 6Q0 721 261 D, 6QE 721 261, 5Q0 721 261, 1U0 721 261 A, 6Q0 721 261 A |
| OCTAVIA III (5E) (13-) | 1,2 TSI | 3) Coull | 02.2013 | | 24.2519-1706.3 | 040096 | NEHMERZYLINDER | 6Q0 721 261 F, 6Q0 721 261 D, 6QE 721 261, 5Q0 721 261, 1U0 721 261 A, 6Q0 721 261 A |
| | 1,4 TSI | 3) Coull | 11.2012 | | 24.2519-1706.3 | 040096 | NEHMERZYLINDER | 6Q0 721 261 F, 6Q0 721 261 D, 6QE 721 261, 5Q0 721 261, 1U0 721 261 A, 6Q0 721 261 A |
| | 1,6 TDI | 3) Coull | 02.2013 | | 24.2519-1706.3 | 040096 | NEHMERZYLINDER | 6Q0 721 261 F, 6Q0 721 261 D, 6QE 721 261, 5Q0 721 261, 1U0 721 261 A, 6Q0 721 261 A |
| | 1,6 TDI 4x4 | 3) Coull | 11.2012 | | 24.2519-1706.3 | 040096 | NEHMERZYLINDER | 6Q0 721 261 F, 6Q0 721 261 D, 6QE 721 261, 5Q0 721 261, 1U0 721 261 A, 6Q0 721 261 A |
| | 1,8 TSI | 3) Coull | 11.2012 | | 24.2519-1706.3 | 040096 | NEHMERZYLINDER | 6Q0 721 261 F, 6Q0 721 261 D, 6QE 721 261, 5Q0 721 261, 1U0 721 261 A, 6Q0 721 261 A |



| | | | | | | | |
|---|----------|---|--|---|--------------------|---|--|
|  | i |  |  |  | Bezeichnung | OE-Nummern zu ATE Artikelnummern | i z.B. Vorsachnummern / diverse |
|---|----------|---|--|---|--------------------|---|--|

SKODA

| | | | | | | | | |
|-------------------------------|-------------|----------|---------|--|----------------|--------|----------------|---|
| OCTAVIA III (5E) (13-) | 1,8 TSI 4x4 | 3) Coull | 11.2012 | | 24.2519-1706.3 | 040096 | NEHMERZYLINDER | 6Q0 721 261 F , 6Q0 721 261 D , 6QE 721 261 , 5Q0 721 261 , 1U0 721 261 A , 6Q0 721 261 A |
| | 2,0 TDI | 3) Coull | 02.2013 | | 24.2519-1706.3 | 040096 | NEHMERZYLINDER | 6Q0 721 261 F , 6Q0 721 261 D , 6QE 721 261 , 5Q0 721 261 , 1U0 721 261 A , 6Q0 721 261 A |
| | | 3) Coull | 11.2012 | | 24.2519-1706.3 | 040096 | NEHMERZYLINDER | 6Q0 721 261 F , 6Q0 721 261 D , 6QE 721 261 , 5Q0 721 261 , 1U0 721 261 A , 6Q0 721 261 A |
| | | 3) Coull | 05.2013 | | 24.2519-1706.3 | 040096 | NEHMERZYLINDER | 6Q0 721 261 F , 6Q0 721 261 D , 6QE 721 261 , 5Q0 721 261 , 1U0 721 261 A , 6Q0 721 261 A |
| | 2,0 TDI 4x4 | 3) Coull | 11.2012 | | 24.2519-1706.3 | 040096 | NEHMERZYLINDER | 6Q0 721 261 F , 6Q0 721 261 D , 6QE 721 261 , 5Q0 721 261 , 1U0 721 261 A , 6Q0 721 261 A |
| | 2,0 TSI RS | 3) Coull | 05.2013 | | 24.2519-1706.3 | 040096 | NEHMERZYLINDER | 6Q0 721 261 F , 6Q0 721 261 D , 6QE 721 261 , 5Q0 721 261 , 1U0 721 261 A , 6Q0 721 261 A |
| RAPID / RAPID Spaceback (12-) | 1,2 | 3) Coull | 10.2012 | | 24.2519-1706.3 | 040096 | NEHMERZYLINDER | 6Q0 721 261 F , 6Q0 721 261 D , 6QE 721 261 , 5Q0 721 261 , 1U0 721 261 A , 6Q0 721 261 A |
| | 1,2 TSI | 3) Coull | 10.2012 | | 24.2519-1706.3 | 040096 | NEHMERZYLINDER | 6Q0 721 261 F , 6Q0 721 261 D , 6QE 721 261 , 5Q0 721 261 , 1U0 721 261 A , 6Q0 721 261 A |
| | 1,4 TSI | 3) Coull | 10.2012 | | 24.2519-1706.3 | 040096 | NEHMERZYLINDER | 6Q0 721 261 F , 6Q0 721 261 D , 6QE 721 261 , 5Q0 721 261 , 1U0 721 261 A , 6Q0 721 261 A |



| | | | | | | | |
|--|----------|--|--|--|--------------------|---|--|
| | i | | | | Bezeichnung | OE-Nummern zu ATE Artikelnummern | i z.B. Vorsachnummern / diverse |
|--|----------|--|--|--|--------------------|---|--|

SKODA

| | | | | | | | | |
|-------------------------------|---------|----------|---------|--|----------------|--------|----------------|--|
| RAPID / RAPID Spaceback (12-) | 1,6 | 3) Coull | 07.2013 | | 24.2519-1706.3 | 040096 | NEHMERZYLINDER | 6Q0 721 261 F, 6Q0 721 261 D, 6QE 721 261, 5Q0 721 261, 1U0 721 261 A, 6Q0 721 261 A |
| | 1,6 TDI | 3) Coull | 08.2013 | | 24.2519-1706.3 | 040096 | NEHMERZYLINDER | 6Q0 721 261 F, 6Q0 721 261 D, 6QE 721 261, 5Q0 721 261, 1U0 721 261 A, 6Q0 721 261 A |
| | | 3) Coull | 10.2012 | | 24.2519-1706.3 | 040096 | NEHMERZYLINDER | 6Q0 721 261 F, 6Q0 721 261 D, 6QE 721 261, 5Q0 721 261, 1U0 721 261 A, 6Q0 721 261 A |
| ROOMSTER (5J) (06-) | 1,0 i | 3) Coull | 07.2006 | | 24.2519-1706.3 | 040096 | NEHMERZYLINDER | 6Q0 721 261 F, 6Q0 721 261 D, 6QE 721 261, 5Q0 721 261, 1U0 721 261 A, 6Q0 721 261 A |
| | 1,2 | 3) Coull | 07.2006 | | 24.2519-1706.3 | 040096 | NEHMERZYLINDER | 6Q0 721 261 F, 6Q0 721 261 D, 6QE 721 261, 5Q0 721 261, 1U0 721 261 A, 6Q0 721 261 A |
| | 1,2 TDI | 3) Coull | 03.2010 | | 24.2519-1706.3 | 040096 | NEHMERZYLINDER | 6Q0 721 261 F, 6Q0 721 261 D, 6QE 721 261, 5Q0 721 261, 1U0 721 261 A, 6Q0 721 261 A |
| | 1,2 TSI | 3) Coull | 03.2010 | | 24.2519-1706.3 | 040096 | NEHMERZYLINDER | 6Q0 721 261 F, 6Q0 721 261 D, 6QE 721 261, 5Q0 721 261, 1U0 721 261 A, 6Q0 721 261 A |
| | 1,4 | 3) Coull | 07.2006 | | 24.2519-1706.3 | 040096 | NEHMERZYLINDER | 6Q0 721 261 F, 6Q0 721 261 D, 6QE 721 261, 5Q0 721 261, 1U0 721 261 A, 6Q0 721 261 A |
| | 1,4 TDI | 3) Coull | 07.2006 | | 24.2519-1706.3 | 040096 | NEHMERZYLINDER | 6Q0 721 261 F, 6Q0 721 261 D, 6QE 721 261, 5Q0 721 261, 1U0 721 261 A, 6Q0 721 261 A |



| | | | | | | | |
|--|----------|--|--|--|--------------------|---|--|
| | i | | | | Bezeichnung | OE-Nummern zu ATE Artikelnummern | i z.B. Vorsachnummern / diverse |
|--|----------|--|--|--|--------------------|---|--|

SKODA

| | | | | | | | | |
|---------------------|--------------|----------|---------|--|----------------|--------|----------------|--|
| ROOMSTER (5J) (06-) | 1,6 | 3) Coull | 07.2006 | | 24.2519-1706.3 | 040096 | NEHMERZYLINDER | 6Q0 721 261 F, 6Q0 721 261 D, 6QE 721 261, 5Q0 721 261, 1U0 721 261 A, 6Q0 721 261 A |
| | 1,6 TDI | 3) Coull | 03.2010 | | 24.2519-1706.3 | 040096 | NEHMERZYLINDER | 6Q0 721 261 F, 6Q0 721 261 D, 6QE 721 261, 5Q0 721 261, 1U0 721 261 A, 6Q0 721 261 A |
| | 1,9 TDI | 3) Coull | 07.2006 | | 24.2519-1706.3 | 040096 | NEHMERZYLINDER | 6Q0 721 261 F, 6Q0 721 261 D, 6QE 721 261, 5Q0 721 261, 1U0 721 261 A, 6Q0 721 261 A |
| SUPERB II (08-) | 1,4 TSI | 3) Coull | 08.2008 | | 24.2519-1706.3 | 040096 | NEHMERZYLINDER | 6Q0 721 261 F, 6Q0 721 261 D, 6QE 721 261, 5Q0 721 261, 1U0 721 261 A, 6Q0 721 261 A |
| | 1,6 i 16V | 3) Coull | 08.2008 | | 24.2519-1706.3 | 040096 | NEHMERZYLINDER | 6Q0 721 261 F, 6Q0 721 261 D, 6QE 721 261, 5Q0 721 261, 1U0 721 261 A, 6Q0 721 261 A |
| | 1,6 TDI | 3) Coull | 09.2010 | | 24.2519-1706.3 | 040096 | NEHMERZYLINDER | 6Q0 721 261 F, 6Q0 721 261 D, 6QE 721 261, 5Q0 721 261, 1U0 721 261 A, 6Q0 721 261 A |
| | 1,8 TFSI | 3) Coull | 08.2008 | | 24.2519-1706.3 | 040096 | NEHMERZYLINDER | 6Q0 721 261 F, 6Q0 721 261 D, 6QE 721 261, 5Q0 721 261, 1U0 721 261 A, 6Q0 721 261 A |
| | 1,8 TFSI 4x4 | 3) Coull | 10.2008 | | 24.2519-1706.3 | 040096 | NEHMERZYLINDER | 6Q0 721 261 F, 6Q0 721 261 D, 6QE 721 261, 5Q0 721 261, 1U0 721 261 A, 6Q0 721 261 A |
| | 1,9 TDI | 3) Coull | 08.2008 | | 24.2519-1706.3 | 040096 | NEHMERZYLINDER | 6Q0 721 261 F, 6Q0 721 261 D, 6QE 721 261, 5Q0 721 261, 1U0 721 261 A, 6Q0 721 261 A |



| | | | | | | |
|--|----------|--|--|--------------------|---|--|
| | i | | | Bezeichnung | OE-Nummern zu ATE Artikelnummern | i z.B. Vorsachnummern / diverse |
|--|----------|--|--|--------------------|---|--|

SKODA

| | | | | | | | |
|--------------------|----------------|----------|---------|----------------|--------|----------------|--|
| SUPERB II (08-) | 2,0 TDI | 3) Coull | 08.2008 | 24.2519-1706.3 | 040096 | NEHMERZYLINDER | 6Q0 721 261 F, 6Q0 721 261 D, 6QE 721 261, 5Q0 721 261, 1U0 721 261 A, 6Q0 721 261 A |
| | 2,0 TDI 4x4 | 3) Coull | 10.2008 | 24.2519-1706.3 | 040096 | NEHMERZYLINDER | 6Q0 721 261 F, 6Q0 721 261 D, 6QE 721 261, 5Q0 721 261, 1U0 721 261 A, 6Q0 721 261 A |
| | 2,0 TSI | 3) Coull | 05.2010 | 24.2519-1706.3 | 040096 | NEHMERZYLINDER | 6Q0 721 261 F, 6Q0 721 261 D, 6QE 721 261, 5Q0 721 261, 1U0 721 261 A, 6Q0 721 261 A |
| | 3,6 FSI V6 4x4 | 3) Coull | 11.2008 | 24.2519-1706.3 | 040096 | NEHMERZYLINDER | 6Q0 721 261 F, 6Q0 721 261 D, 6QE 721 261, 5Q0 721 261, 1U0 721 261 A, 6Q0 721 261 A |
| SUPERB Kombi (09-) | 1,4 TSI | 3) Coull | 11.2009 | 24.2519-1706.3 | 040096 | NEHMERZYLINDER | 6Q0 721 261 F, 6Q0 721 261 D, 6QE 721 261, 5Q0 721 261, 1U0 721 261 A, 6Q0 721 261 A |
| | 1,6 TDI | 3) Coull | 09.2010 | 24.2519-1706.3 | 040096 | NEHMERZYLINDER | 6Q0 721 261 F, 6Q0 721 261 D, 6QE 721 261, 5Q0 721 261, 1U0 721 261 A, 6Q0 721 261 A |
| | 1,8 TSI | 3) Coull | 11.2009 | 24.2519-1706.3 | 040096 | NEHMERZYLINDER | 6Q0 721 261 F, 6Q0 721 261 D, 6QE 721 261, 5Q0 721 261, 1U0 721 261 A, 6Q0 721 261 A |
| | 1,8 TSI 4x4 | 3) Coull | 11.2009 | 24.2519-1706.3 | 040096 | NEHMERZYLINDER | 6Q0 721 261 F, 6Q0 721 261 D, 6QE 721 261, 5Q0 721 261, 1U0 721 261 A, 6Q0 721 261 A |
| | 1,9 TDI | 3) Coull | 10.2009 | 24.2519-1706.3 | 040096 | NEHMERZYLINDER | 6Q0 721 261 F, 6Q0 721 261 D, 6QE 721 261, 5Q0 721 261, 1U0 721 261 A, 6Q0 721 261 A |



| | | | | | | | |
|--|----------|--|--|--|--------------------|---|--|
| | i | | | | Bezeichnung | OE-Nummern zu ATE Artikelnummern | i z.B. Vorsachnummern / diverse |
|--|----------|--|--|--|--------------------|---|--|

SKODA

| | | | | | | | | |
|--------------------|-------------|----------|---------|--|----------------|--------|----------------|--|
| SUPERB Kombi (09-) | 2,0 TDI | 3) Coull | 11.2009 | | 24.2519-1706.3 | 040096 | NEHMERZYLINDER | 6Q0 721 261 F, 6Q0 721 261 D, 6QE 721 261, 5Q0 721 261, 1U0 721 261 A, 6Q0 721 261 A |
| | 2,0 TDI 4x4 | 3) Coull | 11.2009 | | 24.2519-1706.3 | 040096 | NEHMERZYLINDER | 6Q0 721 261 F, 6Q0 721 261 D, 6QE 721 261, 5Q0 721 261, 1U0 721 261 A, 6Q0 721 261 A |
| | 2,0 TSI | 3) Coull | 05.2010 | | 24.2519-1706.3 | 040096 | NEHMERZYLINDER | 6Q0 721 261 F, 6Q0 721 261 D, 6QE 721 261, 5Q0 721 261, 1U0 721 261 A, 6Q0 721 261 A |
| | 3,6 V6 4x4 | 3) Coull | 11.2009 | | 24.2519-1706.3 | 040096 | NEHMERZYLINDER | 6Q0 721 261 F, 6Q0 721 261 D, 6QE 721 261, 5Q0 721 261, 1U0 721 261 A, 6Q0 721 261 A |
| YETI (09-) | 1,2 TSI | 3) Coull | 09.2009 | | 24.2519-1706.3 | 040096 | NEHMERZYLINDER | 6Q0 721 261 F, 6Q0 721 261 D, 6QE 721 261, 5Q0 721 261, 1U0 721 261 A, 6Q0 721 261 A |
| | 1,4 TSI | 3) Coull | 06.2010 | | 24.2519-1706.3 | 040096 | NEHMERZYLINDER | 6Q0 721 261 F, 6Q0 721 261 D, 6QE 721 261, 5Q0 721 261, 1U0 721 261 A, 6Q0 721 261 A |
| | 1,6 TDI | 3) Coull | 11.2010 | | 24.2519-1706.3 | 040096 | NEHMERZYLINDER | 6Q0 721 261 F, 6Q0 721 261 D, 6QE 721 261, 5Q0 721 261, 1U0 721 261 A, 6Q0 721 261 A |
| | 1,8 TSI 4x4 | 3) Coull | 05.2009 | | 24.2519-1706.3 | 040096 | NEHMERZYLINDER | 6Q0 721 261 F, 6Q0 721 261 D, 6QE 721 261, 5Q0 721 261, 1U0 721 261 A, 6Q0 721 261 A |
| | | 3) Coull | 11.2009 | | 24.2519-1706.3 | 040096 | NEHMERZYLINDER | 6Q0 721 261 F, 6Q0 721 261 D, 6QE 721 261, 5Q0 721 261, 1U0 721 261 A, 6Q0 721 261 A |



| | | | | | | | |
|--|----------|--|--|--|--------------------|---|--|
| | i | | | | Bezeichnung | OE-Nummern zu ATE Artikelnummern | i z.B. Vorsachnummern / diverse |
|--|----------|--|--|--|--------------------|---|--|

SKODA

| | | | | | | | | | |
|------------|-------------|----------|---------|--|----------------|--------|----------------|---|--|
| YETI (09-) | 2,0 TDI | 3) Coull | 11.2009 | | 24.2519-1706.3 | 040096 | NEHMERZYLINDER | 6Q0 721 261 F , 6Q0 721 261 D , 6QE 721 261 , 5Q0 721 261 , 1U0 721 261 A , 6Q0 721 261 A | |
| | 2,0 TDI 4x4 | 3) Coull | 05.2009 | | 24.2519-1706.3 | 040096 | NEHMERZYLINDER | 6Q0 721 261 F , 6Q0 721 261 D , 6QE 721 261 , 5Q0 721 261 , 1U0 721 261 A , 6Q0 721 261 A | |
| | | 3) Coull | 11.2009 | | 24.2519-1706.3 | 040096 | NEHMERZYLINDER | 6Q0 721 261 F , 6Q0 721 261 D , 6QE 721 261 , 5Q0 721 261 , 1U0 721 261 A , 6Q0 721 261 A | |

SUZUKI

| | | | | | | | | | |
|--------------------|--------------------|----------|---------|--|----------------|--------|-------------|---------------------------|--|
| ALTO (09-) | 1,0 i 12V (AMF310) | 3) Coull | 01.2009 | | 24.3219-1765.3 | 020547 | RADZYLINDER | 44100-4A00D , 53402M68K00 | |
| GRAND VITARA (05-) | 1,6 i 16V 4x4 | 3) Coull | 04.2005 | | 03.0137-0499.2 | 650499 | TBB.-SATZ | 53200-65J01 | |
| | | 3) Coull | 09.2005 | | 03.0137-0499.2 | 650499 | TBB.-SATZ | 53200-65J01 | |



| | | | | | | |
|--|----------|--|--|--------------------|---|--|
| | i | | | Bezeichnung | OE-Nummern zu ATE Artikelnummern | i z.B. Vorsachnummern / diverse |
|--|----------|--|--|--------------------|---|--|

VOLKSWAGEN

| | | | | | | | | |
|------------------------|---------|----------|---------|--|----------------|--------|----------------|---|
| BEETLE (11-) | 1,2 TSI | 3) Coull | 07.2011 | | 24.2519-1706.3 | 040096 | NEHMERZYLINDER | 6Q0 721 261 F , 6Q0 721 261 D , 6QE 721 261 , 5Q0 721 261 , 1U0 721 261 A , 6Q0 721 261 A |
| | 1,4 TSI | 3) Coull | 04.2011 | | 24.2519-1706.3 | 040096 | NEHMERZYLINDER | 6Q0 721 261 F , 6Q0 721 261 D , 6QE 721 261 , 5Q0 721 261 , 1U0 721 261 A , 6Q0 721 261 A |
| | 1,6 TDI | 3) Coull | 10.2011 | | 24.2519-1706.3 | 040096 | NEHMERZYLINDER | 6Q0 721 261 F , 6Q0 721 261 D , 6QE 721 261 , 5Q0 721 261 , 1U0 721 261 A , 6Q0 721 261 A |
| | 2,0 TDI | 3) Coull | 04.2011 | | 24.2519-1706.3 | 040096 | NEHMERZYLINDER | 6Q0 721 261 F , 6Q0 721 261 D , 6QE 721 261 , 5Q0 721 261 , 1U0 721 261 A , 6Q0 721 261 A |
| | 2,0 TSI | 3) Coull | 04.2011 | | 24.2519-1706.3 | 040096 | NEHMERZYLINDER | 6Q0 721 261 F , 6Q0 721 261 D , 6QE 721 261 , 5Q0 721 261 , 1U0 721 261 A , 6Q0 721 261 A |
| | 2,5 | 3) Coull | 04.2011 | | 24.2519-1706.3 | 040096 | NEHMERZYLINDER | 6Q0 721 261 F , 6Q0 721 261 D , 6QE 721 261 , 5Q0 721 261 , 1U0 721 261 A , 6Q0 721 261 A |
| BEETLE Cabriolet (12-) | 1,2 TSI | 3) Coull | 11.2012 | | 24.2519-1706.3 | 040096 | NEHMERZYLINDER | 6Q0 721 261 F , 6Q0 721 261 D , 6QE 721 261 , 5Q0 721 261 , 1U0 721 261 A , 6Q0 721 261 A |
| | 1,4 TSI | 3) Coull | 11.2012 | | 24.2519-1706.3 | 040096 | NEHMERZYLINDER | 6Q0 721 261 F , 6Q0 721 261 D , 6QE 721 261 , 5Q0 721 261 , 1U0 721 261 A , 6Q0 721 261 A |
| | 1,6 TDI | 3) Coull | 11.2012 | | 24.2519-1706.3 | 040096 | NEHMERZYLINDER | 6Q0 721 261 F , 6Q0 721 261 D , 6QE 721 261 , 5Q0 721 261 , 1U0 721 261 A , 6Q0 721 261 A |



| | | | | | | | |
|--|----------|--|--|--|--------------------|---|--|
| | i | | | | Bezeichnung | OE-Nummern zu ATE Artikelnummern | i z.B. Vorsachnummern / diverse |
|--|----------|--|--|--|--------------------|---|--|

VOLKSWAGEN

| | | | | | | | | |
|------------------------|---------|----------|---------|--|----------------|--------|----------------|--|
| BEETLE Cabriolet (12-) | 2,0 TDI | 3) Coull | 11.2012 | | 24.2519-1706.3 | 040096 | NEHMERZYLINDER | 6Q0 721 261 F, 6Q0 721 261 D, 6QE 721 261, 5Q0 721 261, 1U0 721 261 A, 6Q0 721 261 A |
| | 2,0 TSI | 3) Coull | 05.2013 | | 24.2519-1706.3 | 040096 | NEHMERZYLINDER | 6Q0 721 261 F, 6Q0 721 261 D, 6QE 721 261, 5Q0 721 261, 1U0 721 261 A, 6Q0 721 261 A |
| | | 3) Coull | 11.2012 | | 24.2519-1706.3 | 040096 | NEHMERZYLINDER | 6Q0 721 261 F, 6Q0 721 261 D, 6QE 721 261, 5Q0 721 261, 1U0 721 261 A, 6Q0 721 261 A |
| CADDY III (04-) | 1,2 TSI | 3) Coull | 09.2010 | | 24.2519-1706.3 | 040096 | NEHMERZYLINDER | 6Q0 721 261 F, 6Q0 721 261 D, 6QE 721 261, 5Q0 721 261, 1U0 721 261 A, 6Q0 721 261 A |
| | 1,4 | 3) Coull | 02.2004 | | 24.2519-1706.3 | 040096 | NEHMERZYLINDER | 6Q0 721 261 F, 6Q0 721 261 D, 6QE 721 261, 5Q0 721 261, 1U0 721 261 A, 6Q0 721 261 A |
| | 1,4 16V | 3) Coull | 05.2006 | | 24.2519-1706.3 | 040096 | NEHMERZYLINDER | 6Q0 721 261 F, 6Q0 721 261 D, 6QE 721 261, 5Q0 721 261, 1U0 721 261 A, 6Q0 721 261 A |
| | 1,6 | 3) Coull | 04.2004 | | 24.2519-1706.3 | 040096 | NEHMERZYLINDER | 6Q0 721 261 F, 6Q0 721 261 D, 6QE 721 261, 5Q0 721 261, 1U0 721 261 A, 6Q0 721 261 A |
| | 1,6 TDI | 3) Coull | 08.2010 | | 24.2519-1706.3 | 040096 | NEHMERZYLINDER | 6Q0 721 261 F, 6Q0 721 261 D, 6QE 721 261, 5Q0 721 261, 1U0 721 261 A, 6Q0 721 261 A |
| | 1,9 TDI | 3) Coull | 09.2005 | | 24.2519-1706.3 | 040096 | NEHMERZYLINDER | 6Q0 721 261 F, 6Q0 721 261 D, 6QE 721 261, 5Q0 721 261, 1U0 721 261 A, 6Q0 721 261 A |



Bezeichnung

OE-Nummern
zu ATE
Artikelnummern



z.B. Vorsachnummern /
diverse

VOLKSWAGEN

| | | | | | | | | | |
|-----------------|-----------------|----------|---------|--|----------------|--------|----------------|--|--|
| CADDY III (04-) | 1,9 TDI | 3) Coull | 02.2004 | | 24.2519-1706.3 | 040096 | NEHMERZYLINDER | 6Q0 721 261 F, 6Q0 721 261 D, 6QE 721 261, 5Q0 721 261, 1U0 721 261 A, 6Q0 721 261 A | |
| | 1,9 TDI 4motion | 3) Coull | 05.2008 | | 24.2519-1706.3 | 040096 | NEHMERZYLINDER | 6Q0 721 261 F, 6Q0 721 261 D, 6QE 721 261, 5Q0 721 261, 1U0 721 261 A, 6Q0 721 261 A | |
| | 2,0 Eco Fuel | 3) Coull | 04.2006 | | 24.2519-1706.3 | 040096 | NEHMERZYLINDER | 6Q0 721 261 F, 6Q0 721 261 D, 6QE 721 261, 5Q0 721 261, 1U0 721 261 A, 6Q0 721 261 A | |
| | 2,0 SDI | 3) Coull | 02.2004 | | 24.2519-1706.3 | 040096 | NEHMERZYLINDER | 6Q0 721 261 F, 6Q0 721 261 D, 6QE 721 261, 5Q0 721 261, 1U0 721 261 A, 6Q0 721 261 A | |
| | 2,0 TDI | 3) Coull | 10.2010 | | 24.2519-1706.3 | 040096 | NEHMERZYLINDER | 6Q0 721 261 F, 6Q0 721 261 D, 6QE 721 261, 5Q0 721 261, 1U0 721 261 A, 6Q0 721 261 A | |
| | | 3) Coull | 09.2007 | | 24.2519-1706.3 | 040096 | NEHMERZYLINDER | 6Q0 721 261 F, 6Q0 721 261 D, 6QE 721 261, 5Q0 721 261, 1U0 721 261 A, 6Q0 721 261 A | |
| | | 3) Coull | 05.2012 | | 24.2519-1706.3 | 040096 | NEHMERZYLINDER | 6Q0 721 261 F, 6Q0 721 261 D, 6QE 721 261, 5Q0 721 261, 1U0 721 261 A, 6Q0 721 261 A | |
| | 2,0 TDI 4motion | 3) Coull | 10.2010 | | 24.2519-1706.3 | 040096 | NEHMERZYLINDER | 6Q0 721 261 F, 6Q0 721 261 D, 6QE 721 261, 5Q0 721 261, 1U0 721 261 A, 6Q0 721 261 A | |
| EOS (06-) | 1,4 TSI | 3) Coull | 11.2013 | | 24.2519-1706.3 | 040096 | NEHMERZYLINDER | 6Q0 721 261 F, 6Q0 721 261 D, 6QE 721 261, 5Q0 721 261, 1U0 721 261 A, 6Q0 721 261 A | |



| | | | | | | |
|--|----------|--|--|--------------------|---|--|
| | i | | | Bezeichnung | OE-Nummern zu ATE Artikelnummern | i z.B. Vorsachnummern / diverse |
|--|----------|--|--|--------------------|---|--|

VOLKSWAGEN

| | | | | | | | | | |
|-----------|----------|----------|---------|--|----------------|--------|----------------|---|--|
| EOS (06-) | 1,4 TSI | 3) Coull | 10.2007 | | 24.2519-1706.3 | 040096 | NEHMERZYLINDER | 6Q0 721 261 F , 6Q0 721 261 D , 6QE 721 261 , 5Q0 721 261 , 1U0 721 261 A , 6Q0 721 261 A | |
| | | 3) Coull | 05.2008 | | 24.2519-1706.3 | 040096 | NEHMERZYLINDER | 6Q0 721 261 F , 6Q0 721 261 D , 6QE 721 261 , 5Q0 721 261 , 1U0 721 261 A , 6Q0 721 261 A | |
| | 1,6 FSI | 3) Coull | 05.2006 | | 24.2519-1706.3 | 040096 | NEHMERZYLINDER | 6Q0 721 261 F , 6Q0 721 261 D , 6QE 721 261 , 5Q0 721 261 , 1U0 721 261 A , 6Q0 721 261 A | |
| | 2,0 FSI | 3) Coull | 05.2006 | | 24.2519-1706.3 | 040096 | NEHMERZYLINDER | 6Q0 721 261 F , 6Q0 721 261 D , 6QE 721 261 , 5Q0 721 261 , 1U0 721 261 A , 6Q0 721 261 A | |
| | 2,0 TDI | 3) Coull | 11.2010 | | 24.2519-1706.3 | 040096 | NEHMERZYLINDER | 6Q0 721 261 F , 6Q0 721 261 D , 6QE 721 261 , 5Q0 721 261 , 1U0 721 261 A , 6Q0 721 261 A | |
| | | 3) Coull | 05.2006 | | 24.2519-1706.3 | 040096 | NEHMERZYLINDER | 6Q0 721 261 F , 6Q0 721 261 D , 6QE 721 261 , 5Q0 721 261 , 1U0 721 261 A , 6Q0 721 261 A | |
| | 2,0 TFSI | 3) Coull | 11.2013 | | 24.2519-1706.3 | 040096 | NEHMERZYLINDER | 6Q0 721 261 F , 6Q0 721 261 D , 6QE 721 261 , 5Q0 721 261 , 1U0 721 261 A , 6Q0 721 261 A | |
| | | 3) Coull | 05.2006 | | 24.2519-1706.3 | 040096 | NEHMERZYLINDER | 6Q0 721 261 F , 6Q0 721 261 D , 6QE 721 261 , 5Q0 721 261 , 1U0 721 261 A , 6Q0 721 261 A | |
| | 2,0 TSI | 3) Coull | 11.2009 | | 24.2519-1706.3 | 040096 | NEHMERZYLINDER | 6Q0 721 261 F , 6Q0 721 261 D , 6QE 721 261 , 5Q0 721 261 , 1U0 721 261 A , 6Q0 721 261 A | |



| | | | | | | | |
|--|----------|--|--|--|--------------------|---|--|
| | i | | | | Bezeichnung | OE-Nummern zu ATE Artikelnummern | i z.B. Vorsachnummern / diverse |
|--|----------|--|--|--|--------------------|---|--|

VOLKSWAGEN

| | | | | | | | | |
|-------------------|---------|----------|---------|---------|----------------|--------|----------------|---|
| EOS (06-) | 3,2 V6 | 3) Coull | 05.2006 | | 24.2519-1706.3 | 040096 | NEHMERZYLINDER | 6Q0 721 261 F , 6Q0 721 261 D , 6QE 721 261 , 5Q0 721 261 , 1U0 721 261 A , 6Q0 721 261 A |
| | 3,6 V6 | 3) Coull | 05.2009 | | 24.2519-1706.3 | 040096 | NEHMERZYLINDER | 6Q0 721 261 F , 6Q0 721 261 D , 6QE 721 261 , 5Q0 721 261 , 1U0 721 261 A , 6Q0 721 261 A |
| FOX (05-) | 1 | 3) Coull | 10.2003 | | 24.2519-1706.3 | 040096 | NEHMERZYLINDER | 6Q0 721 261 F , 6Q0 721 261 D , 6QE 721 261 , 5Q0 721 261 , 1U0 721 261 A , 6Q0 721 261 A |
| | 1,2 | 3) Coull | 04.2005 | | 24.2519-1706.3 | 040096 | NEHMERZYLINDER | 6Q0 721 261 F , 6Q0 721 261 D , 6QE 721 261 , 5Q0 721 261 , 1U0 721 261 A , 6Q0 721 261 A |
| | 1,4 | 3) Coull | 04.2005 | | 24.2519-1706.3 | 040096 | NEHMERZYLINDER | 6Q0 721 261 F , 6Q0 721 261 D , 6QE 721 261 , 5Q0 721 261 , 1U0 721 261 A , 6Q0 721 261 A |
| | 1,4 TDI | 3) Coull | 04.2005 | | 24.2519-1706.3 | 040096 | NEHMERZYLINDER | 6Q0 721 261 F , 6Q0 721 261 D , 6QE 721 261 , 5Q0 721 261 , 1U0 721 261 A , 6Q0 721 261 A |
| | 1,6 | 3) Coull | 10.2003 | | 24.2519-1706.3 | 040096 | NEHMERZYLINDER | 6Q0 721 261 F , 6Q0 721 261 D , 6QE 721 261 , 5Q0 721 261 , 1U0 721 261 A , 6Q0 721 261 A |
| | 1,9 D | 3) Coull | 12.2007 | | 24.2519-1706.3 | 040096 | NEHMERZYLINDER | 6Q0 721 261 F , 6Q0 721 261 D , 6QE 721 261 , 5Q0 721 261 , 1U0 721 261 A , 6Q0 721 261 A |
| GOLF Plus (05-14) | 1,2 TSI | 3) Coull | 08.2009 | 01.2014 | 24.2519-1706.3 | 040096 | NEHMERZYLINDER | 6Q0 721 261 F , 6Q0 721 261 D , 6QE 721 261 , 5Q0 721 261 , 1U0 721 261 A , 6Q0 721 261 A |



| | | | | | | | |
|--|----------|--|--|--|--------------------|---|--|
| | i | | | | Bezeichnung | OE-Nummern zu ATE Artikelnummern | i z.B. Vorsachnummern / diverse |
|--|----------|--|--|--|--------------------|---|--|

VOLKSWAGEN

| | | | | | | | | |
|-------------------|------------|----------|---------|---------|----------------|--------|----------------|--|
| GOLF Plus (05-14) | 1,4 16V | 3) Coull | 01.2005 | 01.2014 | 24.2519-1706.3 | 040096 | NEHMERZYLINDER | 6Q0 721 261 F, 6Q0 721 261 D, 6QE 721 261, 5Q0 721 261, 1U0 721 261 A, 6Q0 721 261 A |
| | 1,4 FSI | 3) Coull | 07.2005 | 01.2014 | 24.2519-1706.3 | 040096 | NEHMERZYLINDER | 6Q0 721 261 F, 6Q0 721 261 D, 6QE 721 261, 5Q0 721 261, 1U0 721 261 A, 6Q0 721 261 A |
| | 1,4 TSI | 3) Coull | 05.2006 | 01.2014 | 24.2519-1706.3 | 040096 | NEHMERZYLINDER | 6Q0 721 261 F, 6Q0 721 261 D, 6QE 721 261, 5Q0 721 261, 1U0 721 261 A, 6Q0 721 261 A |
| | | 3) Coull | 06.2007 | 01.2014 | 24.2519-1706.3 | 040096 | NEHMERZYLINDER | 6Q0 721 261 F, 6Q0 721 261 D, 6QE 721 261, 5Q0 721 261, 1U0 721 261 A, 6Q0 721 261 A |
| | | 3) Coull | 06.2008 | 01.2014 | 24.2519-1706.3 | 040096 | NEHMERZYLINDER | 6Q0 721 261 F, 6Q0 721 261 D, 6QE 721 261, 5Q0 721 261, 1U0 721 261 A, 6Q0 721 261 A |
| | 1,6 | 3) Coull | 05.2005 | 01.2014 | 24.2519-1706.3 | 040096 | NEHMERZYLINDER | 6Q0 721 261 F, 6Q0 721 261 D, 6QE 721 261, 5Q0 721 261, 1U0 721 261 A, 6Q0 721 261 A |
| | 1,6 BiFuel | 3) Coull | 05.2009 | 01.2014 | 24.2519-1706.3 | 040096 | NEHMERZYLINDER | 6Q0 721 261 F, 6Q0 721 261 D, 6QE 721 261, 5Q0 721 261, 1U0 721 261 A, 6Q0 721 261 A |
| | 1,6 FSI | 3) Coull | 01.2005 | 01.2014 | 24.2519-1706.3 | 040096 | NEHMERZYLINDER | 6Q0 721 261 F, 6Q0 721 261 D, 6QE 721 261, 5Q0 721 261, 1U0 721 261 A, 6Q0 721 261 A |
| | 1,6 TDI | 3) Coull | 02.2009 | 01.2014 | 24.2519-1706.3 | 040096 | NEHMERZYLINDER | 6Q0 721 261 F, 6Q0 721 261 D, 6QE 721 261, 5Q0 721 261, 1U0 721 261 A, 6Q0 721 261 A |







| | | | | | | | |
|--|----------|--|--|--|--------------------|---|--|
| | i | | | | Bezeichnung | OE-Nummern zu ATE Artikelnummern | i z.B. Vorsachnummern / diverse |
|--|----------|--|--|--|--------------------|---|--|

VOLKSWAGEN

| | | | | | | | | |
|-------------------|---------|----------|---------|---------|----------------|--------|----------------|---|
| GOLF Plus (05-14) | 1,9 TDI | 3) Coull | 05.2005 | 01.2014 | 24.2519-1706.3 | 040096 | NEHMERZYLINDER | 6Q0 721 261 F , 6Q0 721 261 D , 6QE 721 261 , 5Q0 721 261 , 1U0 721 261 A , 6Q0 721 261 A |
| | | 3) Coull | 01.2005 | 01.2014 | 24.2519-1706.3 | 040096 | NEHMERZYLINDER | 6Q0 721 261 F , 6Q0 721 261 D , 6QE 721 261 , 5Q0 721 261 , 1U0 721 261 A , 6Q0 721 261 A |
| | 2,0 FSI | 3) Coull | 05.2005 | 01.2014 | 24.2519-1706.3 | 040096 | NEHMERZYLINDER | 6Q0 721 261 F , 6Q0 721 261 D , 6QE 721 261 , 5Q0 721 261 , 1U0 721 261 A , 6Q0 721 261 A |
| | 2,0 TDI | 3) Coull | 01.2005 | 01.2014 | 24.2519-1706.3 | 040096 | NEHMERZYLINDER | 6Q0 721 261 F , 6Q0 721 261 D , 6QE 721 261 , 5Q0 721 261 , 1U0 721 261 A , 6Q0 721 261 A |
| | | 3) Coull | 01.2009 | 01.2014 | 24.2519-1706.3 | 040096 | NEHMERZYLINDER | 6Q0 721 261 F , 6Q0 721 261 D , 6QE 721 261 , 5Q0 721 261 , 1U0 721 261 A , 6Q0 721 261 A |
| | | 3) Coull | 05.2005 | 01.2014 | 24.2519-1706.3 | 040096 | NEHMERZYLINDER | 6Q0 721 261 F , 6Q0 721 261 D , 6QE 721 261 , 5Q0 721 261 , 1U0 721 261 A , 6Q0 721 261 A |
| GOLF V (03-08) | 1,4 16V | 3) Coull | 10.2003 | 09.2008 | 24.2519-1706.3 | 040096 | NEHMERZYLINDER | 6Q0 721 261 F , 6Q0 721 261 D , 6QE 721 261 , 5Q0 721 261 , 1U0 721 261 A , 6Q0 721 261 A |
| | 1,4 FSI | 3) Coull | 10.2003 | 09.2008 | 24.2519-1706.3 | 040096 | NEHMERZYLINDER | 6Q0 721 261 F , 6Q0 721 261 D , 6QE 721 261 , 5Q0 721 261 , 1U0 721 261 A , 6Q0 721 261 A |
| | 1,4 TSI | 3) Coull | 05.2007 | 09.2008 | 24.2519-1706.3 | 040096 | NEHMERZYLINDER | 6Q0 721 261 F , 6Q0 721 261 D , 6QE 721 261 , 5Q0 721 261 , 1U0 721 261 A , 6Q0 721 261 A |



| | | | | | | | |
|---|---|---|--|---|--------------------|---|---|
|  |  |  |  |  | Bezeichnung | OE-Nummern zu ATE Artikelnummern |  z.B. Vorsachnummern / diverse |
|---|---|---|--|---|--------------------|---|---|

VOLKSWAGEN

| | | | | | | | | |
|------------------------|---------|----------|---------|---------|----------------|--------|----------------|--|
| GOLF V (03-08) | 1,6 16V | 3) Coull | 01.2004 | 09.2008 | 24.2519-1706.3 | 040096 | NEHMERZYLINDER | 6Q0 721 261 F, 6Q0 721 261 D, 6QE 721 261, 5Q0 721 261, 1U0 721 261 A, 6Q0 721 261 A |
| | 1,6 FSI | 3) Coull | 10.2003 | 09.2008 | 24.2519-1706.3 | 040096 | NEHMERZYLINDER | 6Q0 721 261 F, 6Q0 721 261 D, 6QE 721 261, 5Q0 721 261, 1U0 721 261 A, 6Q0 721 261 A |
| | 1,9 TDI | 3) Coull | 05.2004 | 09.2008 | 24.2519-1706.3 | 040096 | NEHMERZYLINDER | 6Q0 721 261 F, 6Q0 721 261 D, 6QE 721 261, 5Q0 721 261, 1U0 721 261 A, 6Q0 721 261 A |
| | 2,0 GTI | 3) Coull | 09.2006 | 09.2008 | 24.2519-1706.3 | 040096 | NEHMERZYLINDER | 6Q0 721 261 F, 6Q0 721 261 D, 6QE 721 261, 5Q0 721 261, 1U0 721 261 A, 6Q0 721 261 A |
| | | 3) Coull | 09.2004 | 09.2008 | 24.2519-1706.3 | 040096 | NEHMERZYLINDER | 6Q0 721 261 F, 6Q0 721 261 D, 6QE 721 261, 5Q0 721 261, 1U0 721 261 A, 6Q0 721 261 A |
| | 2,0 SDI | 3) Coull | 01.2004 | 09.2008 | 24.2519-1706.3 | 040096 | NEHMERZYLINDER | 6Q0 721 261 F, 6Q0 721 261 D, 6QE 721 261, 5Q0 721 261, 1U0 721 261 A, 6Q0 721 261 A |
| | 2,0 TDI | 3) Coull | 10.2003 | 09.2008 | 24.2519-1706.3 | 040096 | NEHMERZYLINDER | 6Q0 721 261 F, 6Q0 721 261 D, 6QE 721 261, 5Q0 721 261, 1U0 721 261 A, 6Q0 721 261 A |
| | | 3) Coull | 11.2005 | 09.2008 | 24.2519-1706.3 | 040096 | NEHMERZYLINDER | 6Q0 721 261 F, 6Q0 721 261 D, 6QE 721 261, 5Q0 721 261, 1U0 721 261 A, 6Q0 721 261 A |
| GOLF V Variant (07-09) | 1,4 | 3) Coull | 06.2007 | 06.2009 | 24.2519-1706.3 | 040096 | NEHMERZYLINDER | 6Q0 721 261 F, 6Q0 721 261 D, 6QE 721 261, 5Q0 721 261, 1U0 721 261 A, 6Q0 721 261 A |



| | | | | | | |
|--|----------|--|--|--------------------|---|--|
| | i | | | Bezeichnung | OE-Nummern zu ATE Artikelnummern | i z.B. Vorsachnummern / diverse |
|--|----------|--|--|--------------------|---|--|

VOLKSWAGEN

| | | | | | | | | | |
|------------------------|-----------------|----------|---------|---------|----------------|--------|----------------|---|--|
| GOLF V Variant (07-09) | 1,4 TSI | 3) Coull | 05.2007 | 06.2009 | 24.2519-1706.3 | 040096 | NEHMERZYLINDER | 6Q0 721 261 F , 6Q0 721 261 D , 6QE 721 261 , 5Q0 721 261 , 1U0 721 261 A , 6Q0 721 261 A | |
| | | 3) Coull | 06.2007 | 06.2009 | 24.2519-1706.3 | 040096 | NEHMERZYLINDER | 6Q0 721 261 F , 6Q0 721 261 D , 6QE 721 261 , 5Q0 721 261 , 1U0 721 261 A , 6Q0 721 261 A | |
| | | 3) Coull | 07.2008 | 06.2009 | 24.2519-1706.3 | 040096 | NEHMERZYLINDER | 6Q0 721 261 F , 6Q0 721 261 D , 6QE 721 261 , 5Q0 721 261 , 1U0 721 261 A , 6Q0 721 261 A | |
| | 1,6 | 3) Coull | 05.2007 | 06.2009 | 24.2519-1706.3 | 040096 | NEHMERZYLINDER | 6Q0 721 261 F , 6Q0 721 261 D , 6QE 721 261 , 5Q0 721 261 , 1U0 721 261 A , 6Q0 721 261 A | |
| | 1,9 TDI | 3) Coull | 05.2007 | 06.2009 | 24.2519-1706.3 | 040096 | NEHMERZYLINDER | 6Q0 721 261 F , 6Q0 721 261 D , 6QE 721 261 , 5Q0 721 261 , 1U0 721 261 A , 6Q0 721 261 A | |
| | 1,9 TDI 4motion | 3) Coull | 12.2007 | 06.2009 | 24.2519-1706.3 | 040096 | NEHMERZYLINDER | 6Q0 721 261 F , 6Q0 721 261 D , 6QE 721 261 , 5Q0 721 261 , 1U0 721 261 A , 6Q0 721 261 A | |
| | 2 | 3) Coull | 06.2007 | 06.2009 | 24.2519-1706.3 | 040096 | NEHMERZYLINDER | 6Q0 721 261 F , 6Q0 721 261 D , 6QE 721 261 , 5Q0 721 261 , 1U0 721 261 A , 6Q0 721 261 A | |
| | 2,0 TDI | 3) Coull | 05.2007 | 06.2009 | 24.2519-1706.3 | 040096 | NEHMERZYLINDER | 6Q0 721 261 F , 6Q0 721 261 D , 6QE 721 261 , 5Q0 721 261 , 1U0 721 261 A , 6Q0 721 261 A | |
| GOLF VI (08-) | 1,2 TSI | 3) Coull | 05.2009 | | 24.2519-1706.3 | 040096 | NEHMERZYLINDER | 6Q0 721 261 F , 6Q0 721 261 D , 6QE 721 261 , 5Q0 721 261 , 1U0 721 261 A , 6Q0 721 261 A | |



| | | | | | | | |
|--|----------|--|--|--|--------------------|---|--|
| | i | | | | Bezeichnung | OE-Nummern zu ATE Artikelnummern | i z.B. Vorsachnummern / diverse |
|--|----------|--|--|--|--------------------|---|--|

VOLKSWAGEN

| | | | | | | | | |
|---------------|---------------|----------|---------|--|----------------|--------|----------------|---|
| GOLF VI (08-) | 1,4 | 3) Coull | 10.2008 | | 24.2519-1706.3 | 040096 | NEHMERZYLINDER | 6Q0 721 261 F , 6Q0 721 261 D , 6QE 721 261 , 5Q0 721 261 , 1U0 721 261 A , 6Q0 721 261 A |
| | 1,4 TSI | 3) Coull | 10.2008 | | 24.2519-1706.3 | 040096 | NEHMERZYLINDER | 6Q0 721 261 F , 6Q0 721 261 D , 6QE 721 261 , 5Q0 721 261 , 1U0 721 261 A , 6Q0 721 261 A |
| | 1,6 | 3) Coull | 10.2008 | | 24.2519-1706.3 | 040096 | NEHMERZYLINDER | 6Q0 721 261 F , 6Q0 721 261 D , 6QE 721 261 , 5Q0 721 261 , 1U0 721 261 A , 6Q0 721 261 A |
| | 1,6 Bi-Fuel | 3) Coull | 03.2009 | | 24.2519-1706.3 | 040096 | NEHMERZYLINDER | 6Q0 721 261 F , 6Q0 721 261 D , 6QE 721 261 , 5Q0 721 261 , 1U0 721 261 A , 6Q0 721 261 A |
| | 1,6 TDI | 3) Coull | 02.2009 | | 24.2519-1706.3 | 040096 | NEHMERZYLINDER | 6Q0 721 261 F , 6Q0 721 261 D , 6QE 721 261 , 5Q0 721 261 , 1U0 721 261 A , 6Q0 721 261 A |
| | 1,8 TSI | 3) Coull | 06.2009 | | 24.2519-1706.3 | 040096 | NEHMERZYLINDER | 6Q0 721 261 F , 6Q0 721 261 D , 6QE 721 261 , 5Q0 721 261 , 1U0 721 261 A , 6Q0 721 261 A |
| | 2,0 GTI | 3) Coull | 04.2009 | | 24.2519-1706.3 | 040096 | NEHMERZYLINDER | 6Q0 721 261 F , 6Q0 721 261 D , 6QE 721 261 , 5Q0 721 261 , 1U0 721 261 A , 6Q0 721 261 A |
| | 2,0 R 4motion | 3) Coull | 11.2009 | | 24.2519-1706.3 | 040096 | NEHMERZYLINDER | 6Q0 721 261 F , 6Q0 721 261 D , 6QE 721 261 , 5Q0 721 261 , 1U0 721 261 A , 6Q0 721 261 A |
| | 2,0 TDI | 3) Coull | 10.2008 | | 24.2519-1706.3 | 040096 | NEHMERZYLINDER | 6Q0 721 261 F , 6Q0 721 261 D , 6QE 721 261 , 5Q0 721 261 , 1U0 721 261 A , 6Q0 721 261 A |



| | | | | | | |
|--|----------|--|--|--------------------|---|--|
| | i | | | Bezeichnung | OE-Nummern zu ATE Artikelnummern | i z.B. Vorsachnummern / diverse |
|--|----------|--|--|--------------------|---|--|

VOLKSWAGEN

| | | | | | | | | | |
|-------------------------|-----------------|---------|---------|--|----------------|--------|----------------|---|--|
| GOLF VI (08-) | 2,0 TDI | 3) Coup | 04.2009 | | 24.2519-1706.3 | 040096 | NEHMERZYLINDER | 6Q0 721 261 F , 6Q0 721 261 D , 6QE 721 261 , 5Q0 721 261 , 1U0 721 261 A , 6Q0 721 261 A | |
| | 2,0 TDI 4motion | 3) Coup | 10.2008 | | 24.2519-1706.3 | 040096 | NEHMERZYLINDER | 6Q0 721 261 F , 6Q0 721 261 D , 6QE 721 261 , 5Q0 721 261 , 1U0 721 261 A , 6Q0 721 261 A | |
| GOLF VI Cabriolet (11-) | 1,2 TSI | 3) Coup | 06.2011 | | 24.2519-1706.3 | 040096 | NEHMERZYLINDER | 6Q0 721 261 F , 6Q0 721 261 D , 6QE 721 261 , 5Q0 721 261 , 1U0 721 261 A , 6Q0 721 261 A | |
| | 1,4 TSI | 3) Coup | 06.2011 | | 24.2519-1706.3 | 040096 | NEHMERZYLINDER | 6Q0 721 261 F , 6Q0 721 261 D , 6QE 721 261 , 5Q0 721 261 , 1U0 721 261 A , 6Q0 721 261 A | |
| | 1,6 TDI | 3) Coup | 06.2011 | | 24.2519-1706.3 | 040096 | NEHMERZYLINDER | 6Q0 721 261 F , 6Q0 721 261 D , 6QE 721 261 , 5Q0 721 261 , 1U0 721 261 A , 6Q0 721 261 A | |
| | 2,0 R | 3) Coup | 01.2013 | | 24.2519-1706.3 | 040096 | NEHMERZYLINDER | 6Q0 721 261 F , 6Q0 721 261 D , 6QE 721 261 , 5Q0 721 261 , 1U0 721 261 A , 6Q0 721 261 A | |
| | 2,0 TDI | 3) Coup | 06.2011 | | 24.2519-1706.3 | 040096 | NEHMERZYLINDER | 6Q0 721 261 F , 6Q0 721 261 D , 6QE 721 261 , 5Q0 721 261 , 1U0 721 261 A , 6Q0 721 261 A | |
| | 2,0 TSI | 3) Coup | 06.2011 | | 24.2519-1706.3 | 040096 | NEHMERZYLINDER | 6Q0 721 261 F , 6Q0 721 261 D , 6QE 721 261 , 5Q0 721 261 , 1U0 721 261 A , 6Q0 721 261 A | |
| GOLF VI Variant (09-) | 1,2 TSI | 3) Coup | 08.2009 | | 24.2519-1706.3 | 040096 | NEHMERZYLINDER | 6Q0 721 261 F , 6Q0 721 261 D , 6QE 721 261 , 5Q0 721 261 , 1U0 721 261 A , 6Q0 721 261 A | |



Bezeichnung

OE-Nummern
zu ATE
Artikelnummern



z.B. Vorsachnummern /
diverse

VOLKSWAGEN

| | | | | | | | | | |
|-----------------------|-----------------|----------|---------|--|----------------|--------|----------------|--|--|
| GOLF VI Variant (09-) | 1,4 | 3) Coull | 07.2009 | | 24.2519-1706.3 | 040096 | NEHMERZYLINDER | 6Q0 721 261 F, 6Q0 721 261 D, 6QE 721 261, 5Q0 721 261, 1U0 721 261 A, 6Q0 721 261 A | |
| | 1,4 TSI | 3) Coull | 07.2009 | | 24.2519-1706.3 | 040096 | NEHMERZYLINDER | 6Q0 721 261 F, 6Q0 721 261 D, 6QE 721 261, 5Q0 721 261, 1U0 721 261 A, 6Q0 721 261 A | |
| | 1,6 | 3) Coull | 07.2009 | | 24.2519-1706.3 | 040096 | NEHMERZYLINDER | 6Q0 721 261 F, 6Q0 721 261 D, 6QE 721 261, 5Q0 721 261, 1U0 721 261 A, 6Q0 721 261 A | |
| | 1,6 MultiFuel | 3) Coull | 07.2009 | | 24.2519-1706.3 | 040096 | NEHMERZYLINDER | 6Q0 721 261 F, 6Q0 721 261 D, 6QE 721 261, 5Q0 721 261, 1U0 721 261 A, 6Q0 721 261 A | |
| | 1,6 TDI | 3) Coull | 07.2009 | | 24.2519-1706.3 | 040096 | NEHMERZYLINDER | 6Q0 721 261 F, 6Q0 721 261 D, 6QE 721 261, 5Q0 721 261, 1U0 721 261 A, 6Q0 721 261 A | |
| | 1,6 TDI 4motion | 3) Coull | 07.2009 | | 24.2519-1706.3 | 040096 | NEHMERZYLINDER | 6Q0 721 261 F, 6Q0 721 261 D, 6QE 721 261, 5Q0 721 261, 1U0 721 261 A, 6Q0 721 261 A | |
| | 2 | 3) Coull | 07.2009 | | 24.2519-1706.3 | 040096 | NEHMERZYLINDER | 6Q0 721 261 F, 6Q0 721 261 D, 6QE 721 261, 5Q0 721 261, 1U0 721 261 A, 6Q0 721 261 A | |
| | 2,0 TDI | 3) Coull | 07.2009 | | 24.2519-1706.3 | 040096 | NEHMERZYLINDER | 6Q0 721 261 F, 6Q0 721 261 D, 6QE 721 261, 5Q0 721 261, 1U0 721 261 A, 6Q0 721 261 A | |
| GOLF VII (12-) | 1,2 TSI | 3) Coull | 11.2012 | | 24.2519-1706.3 | 040096 | NEHMERZYLINDER | 6Q0 721 261 F, 6Q0 721 261 D, 6QE 721 261, 5Q0 721 261, 1U0 721 261 A, 6Q0 721 261 A | |



| | | | | | | |
|--|----------|--|--|--------------------|---|--|
| | i | | | Bezeichnung | OE-Nummern zu ATE Artikelnummern | i z.B. Vorsachnummern / diverse |
|--|----------|--|--|--------------------|---|--|

VOLKSWAGEN

| | | | | | | | | | |
|----------------|-----------------|----------|---------|--|----------------|--------|----------------|---|--|
| GOLF VII (12-) | 1,4 TGI | 3) Coull | 08.2013 | | 24.2519-1706.3 | 040096 | NEHMERZYLINDER | 6Q0 721 261 F , 6Q0 721 261 D , 6QE 721 261 , 5Q0 721 261 , 1U0 721 261 A , 6Q0 721 261 A | |
| | 1,4 TSI | 3) Coull | 11.2012 | | 24.2519-1706.3 | 040096 | NEHMERZYLINDER | 6Q0 721 261 F , 6Q0 721 261 D , 6QE 721 261 , 5Q0 721 261 , 1U0 721 261 A , 6Q0 721 261 A | |
| | 1,6 TDI | 3) Coull | 06.2013 | | 24.2519-1706.3 | 040096 | NEHMERZYLINDER | 6Q0 721 261 F , 6Q0 721 261 D , 6QE 721 261 , 5Q0 721 261 , 1U0 721 261 A , 6Q0 721 261 A | |
| | | 3) Coull | 11.2012 | | 24.2519-1706.3 | 040096 | NEHMERZYLINDER | 6Q0 721 261 F , 6Q0 721 261 D , 6QE 721 261 , 5Q0 721 261 , 1U0 721 261 A , 6Q0 721 261 A | |
| | | 3) Coull | 04.2013 | | 24.2519-1706.3 | 040096 | NEHMERZYLINDER | 6Q0 721 261 F , 6Q0 721 261 D , 6QE 721 261 , 5Q0 721 261 , 1U0 721 261 A , 6Q0 721 261 A | |
| | 1,6 TDI 4motion | 3) Coull | 01.2013 | | 24.2519-1706.3 | 040096 | NEHMERZYLINDER | 6Q0 721 261 F , 6Q0 721 261 D , 6QE 721 261 , 5Q0 721 261 , 1U0 721 261 A , 6Q0 721 261 A | |
| | | 3) Coull | 11.2012 | | 24.2519-1706.3 | 040096 | NEHMERZYLINDER | 6Q0 721 261 F , 6Q0 721 261 D , 6QE 721 261 , 5Q0 721 261 , 1U0 721 261 A , 6Q0 721 261 A | |
| | 2,0 GTD | 3) Coull | 03.2013 | | 24.2519-1706.3 | 040096 | NEHMERZYLINDER | 6Q0 721 261 F , 6Q0 721 261 D , 6QE 721 261 , 5Q0 721 261 , 1U0 721 261 A , 6Q0 721 261 A | |
| | 2,0 GTI | 3) Coull | 03.2013 | | 24.2519-1706.3 | 040096 | NEHMERZYLINDER | 6Q0 721 261 F , 6Q0 721 261 D , 6QE 721 261 , 5Q0 721 261 , 1U0 721 261 A , 6Q0 721 261 A | |



| | | | | | | | |
|--|----------|--|--|--|--------------------|---|--|
| | i | | | | Bezeichnung | OE-Nummern zu ATE Artikelnummern | i z.B. Vorsachnummern / diverse |
|--|----------|--|--|--|--------------------|---|--|

VOLKSWAGEN

| | | | | | | | | |
|------------------------|---------------------|----------|---------|--|----------------|--------|----------------|---|
| GOLF VII (12-) | 2,0 GTI Performance | 3) Coull | 03.2013 | | 24.2519-1706.3 | 040096 | NEHMERZYLINDER | 6Q0 721 261 F , 6Q0 721 261 D , 6QE 721 261 , 5Q0 721 261 , 1U0 721 261 A , 6Q0 721 261 A |
| | 2,0 R 4motion | 3) Coull | 09.2013 | | 24.2519-1706.3 | 040096 | NEHMERZYLINDER | 6Q0 721 261 F , 6Q0 721 261 D , 6QE 721 261 , 5Q0 721 261 , 1U0 721 261 A , 6Q0 721 261 A |
| | 2,0 TDI | 3) Coull | 11.2012 | | 24.2519-1706.3 | 040096 | NEHMERZYLINDER | 6Q0 721 261 F , 6Q0 721 261 D , 6QE 721 261 , 5Q0 721 261 , 1U0 721 261 A , 6Q0 721 261 A |
| | | 3) Coull | 08.2012 | | 24.2519-1706.3 | 040096 | NEHMERZYLINDER | 6Q0 721 261 F , 6Q0 721 261 D , 6QE 721 261 , 5Q0 721 261 , 1U0 721 261 A , 6Q0 721 261 A |
| | 2,0 TDI 4motion | 3) Coull | 11.2012 | | 24.2519-1706.3 | 040096 | NEHMERZYLINDER | 6Q0 721 261 F , 6Q0 721 261 D , 6QE 721 261 , 5Q0 721 261 , 1U0 721 261 A , 6Q0 721 261 A |
| GOLF VII Variant (13-) | 1,2 TSI | 3) Coull | 07.2013 | | 24.2519-1706.3 | 040096 | NEHMERZYLINDER | 6Q0 721 261 F , 6Q0 721 261 D , 6QE 721 261 , 5Q0 721 261 , 1U0 721 261 A , 6Q0 721 261 A |
| | 1,4 TSI | 3) Coull | 07.2013 | | 24.2519-1706.3 | 040096 | NEHMERZYLINDER | 6Q0 721 261 F , 6Q0 721 261 D , 6QE 721 261 , 5Q0 721 261 , 1U0 721 261 A , 6Q0 721 261 A |
| | 1,4 TSI BiFuel | 3) Coull | 09.2013 | | 24.2519-1706.3 | 040096 | NEHMERZYLINDER | 6Q0 721 261 F , 6Q0 721 261 D , 6QE 721 261 , 5Q0 721 261 , 1U0 721 261 A , 6Q0 721 261 A |
| | 1,4 TSI CNG | 3) Coull | 09.2013 | | 24.2519-1706.3 | 040096 | NEHMERZYLINDER | 6Q0 721 261 F , 6Q0 721 261 D , 6QE 721 261 , 5Q0 721 261 , 1U0 721 261 A , 6Q0 721 261 A |



Bezeichnung

OE-Nummern
zu ATE
Artikelnummern



z.B. Vorsachnummern /
diverse

VOLKSWAGEN

| | | | | | | | | | |
|------------------------|-----------------|----------|---------|---------|----------------|--------|----------------|--|--|
| GOLF VII Variant (13-) | 1,6 TDI | 3) Coull | 07.2013 | | 24.2519-1706.3 | 040096 | NEHMERZYLINDER | 6Q0 721 261 F, 6Q0 721 261 D, 6QE 721 261, 5Q0 721 261, 1U0 721 261 A, 6Q0 721 261 A | |
| | 1,6 TDI 4motion | 3) Coull | 07.2013 | | 24.2519-1706.3 | 040096 | NEHMERZYLINDER | 6Q0 721 261 F, 6Q0 721 261 D, 6QE 721 261, 5Q0 721 261, 1U0 721 261 A, 6Q0 721 261 A | |
| | 2,0 GTD | 3) Coull | 07.2013 | | 24.2519-1706.3 | 040096 | NEHMERZYLINDER | 6Q0 721 261 F, 6Q0 721 261 D, 6QE 721 261, 5Q0 721 261, 1U0 721 261 A, 6Q0 721 261 A | |
| | 2,0 TDI | 3) Coull | 07.2013 | | 24.2519-1706.3 | 040096 | NEHMERZYLINDER | 6Q0 721 261 F, 6Q0 721 261 D, 6QE 721 261, 5Q0 721 261, 1U0 721 261 A, 6Q0 721 261 A | |
| | 2,0 TDI 4motion | 3) Coull | 07.2013 | | 24.2519-1706.3 | 040096 | NEHMERZYLINDER | 6Q0 721 261 F, 6Q0 721 261 D, 6QE 721 261, 5Q0 721 261, 1U0 721 261 A, 6Q0 721 261 A | |
| JETTA V (05-10) | 1,4 TSI | 3) Coull | 05.2007 | 10.2010 | 24.2519-1706.3 | 040096 | NEHMERZYLINDER | 6Q0 721 261 F, 6Q0 721 261 D, 6QE 721 261, 5Q0 721 261, 1U0 721 261 A, 6Q0 721 261 A | |
| | | 3) Coull | 06.2006 | 10.2010 | 24.2519-1706.3 | 040096 | NEHMERZYLINDER | 6Q0 721 261 F, 6Q0 721 261 D, 6QE 721 261, 5Q0 721 261, 1U0 721 261 A, 6Q0 721 261 A | |
| | 1,6 FSI | 3) Coull | 08.2005 | 10.2010 | 24.2519-1706.3 | 040096 | NEHMERZYLINDER | 6Q0 721 261 F, 6Q0 721 261 D, 6QE 721 261, 5Q0 721 261, 1U0 721 261 A, 6Q0 721 261 A | |
| | 1,6 i 16V | 3) Coull | 08.2005 | 10.2010 | 24.2519-1706.3 | 040096 | NEHMERZYLINDER | 6Q0 721 261 F, 6Q0 721 261 D, 6QE 721 261, 5Q0 721 261, 1U0 721 261 A, 6Q0 721 261 A | |







| | | | | | | |
|--|----------|--|--|--------------------|---|--|
| | i | | | Bezeichnung | OE-Nummern zu ATE Artikelnummern | i z.B. Vorsachnummern / diverse |
|--|----------|--|--|--------------------|---|--|

VOLKSWAGEN

| | | | | | | | | |
|-----------------|----------------|----------|---------|---------|----------------|--------|----------------|---|
| JETTA V (05-10) | 1,6 TDI | 3) Coull | 06.2009 | 10.2010 | 24.2519-1706.3 | 040096 | NEHMERZYLINDER | 6Q0 721 261 F , 6Q0 721 261 D , 6QE 721 261 , 5Q0 721 261 , 1U0 721 261 A , 6Q0 721 261 A |
| | 1,9 TDI | 3) Coull | 08.2005 | 10.2010 | 24.2519-1706.3 | 040096 | NEHMERZYLINDER | 6Q0 721 261 F , 6Q0 721 261 D , 6QE 721 261 , 5Q0 721 261 , 1U0 721 261 A , 6Q0 721 261 A |
| | 2,0 FSI | 3) Coull | 08.2005 | 10.2010 | 24.2519-1706.3 | 040096 | NEHMERZYLINDER | 6Q0 721 261 F , 6Q0 721 261 D , 6QE 721 261 , 5Q0 721 261 , 1U0 721 261 A , 6Q0 721 261 A |
| | 2,0 TDI | 3) Coull | 06.2006 | 10.2010 | 24.2519-1706.3 | 040096 | NEHMERZYLINDER | 6Q0 721 261 F , 6Q0 721 261 D , 6QE 721 261 , 5Q0 721 261 , 1U0 721 261 A , 6Q0 721 261 A |
| | | 3) Coull | 08.2005 | 10.2010 | 24.2519-1706.3 | 040096 | NEHMERZYLINDER | 6Q0 721 261 F , 6Q0 721 261 D , 6QE 721 261 , 5Q0 721 261 , 1U0 721 261 A , 6Q0 721 261 A |
| | | 3) Coull | 09.2005 | 10.2010 | 24.2519-1706.3 | 040096 | NEHMERZYLINDER | 6Q0 721 261 F , 6Q0 721 261 D , 6QE 721 261 , 5Q0 721 261 , 1U0 721 261 A , 6Q0 721 261 A |
| JETTA VI (11-) | 1,2 TSI | 3) Coull | 04.2011 | | 24.2519-1706.3 | 040096 | NEHMERZYLINDER | 6Q0 721 261 F , 6Q0 721 261 D , 6QE 721 261 , 5Q0 721 261 , 1U0 721 261 A , 6Q0 721 261 A |
| | 1,4 TSI | 3) Coull | 04.2011 | | 24.2519-1706.3 | 040096 | NEHMERZYLINDER | 6Q0 721 261 F , 6Q0 721 261 D , 6QE 721 261 , 5Q0 721 261 , 1U0 721 261 A , 6Q0 721 261 A |
| | 1,4 TSI Hybrid | 3) Coull | 04.2011 | | 24.2519-1706.3 | 040096 | NEHMERZYLINDER | 6Q0 721 261 F , 6Q0 721 261 D , 6QE 721 261 , 5Q0 721 261 , 1U0 721 261 A , 6Q0 721 261 A |



| | | | | | | | |
|---|---|---|--|---|--------------------|---|---|
|  |  |  |  |  | Bezeichnung | OE-Nummern zu ATE Artikelnummern |  z.B. Vorsachnummern / diverse |
|---|---|---|--|---|--------------------|---|---|

VOLKSWAGEN

| | | | | | | | | |
|-------------------------------|---------|----------|---------|---------|----------------|--------|----------------|---|
| JETTA VI (11-) | 1,6 | 3) Coull | 12.2011 | | 24.2519-1706.3 | 040096 | NEHMERZYLINDER | 6Q0 721 261 F , 6Q0 721 261 D , 6QE 721 261 , 5Q0 721 261 , 1U0 721 261 A , 6Q0 721 261 A |
| | 1,6 TDI | 3) Coull | 04.2011 | | 24.2519-1706.3 | 040096 | NEHMERZYLINDER | 6Q0 721 261 F , 6Q0 721 261 D , 6QE 721 261 , 5Q0 721 261 , 1U0 721 261 A , 6Q0 721 261 A |
| | 2,0 TDI | 3) Coull | 04.2011 | | 24.2519-1706.3 | 040096 | NEHMERZYLINDER | 6Q0 721 261 F , 6Q0 721 261 D , 6QE 721 261 , 5Q0 721 261 , 1U0 721 261 A , 6Q0 721 261 A |
| | 2,0 TSI | 3) Coull | 12.2012 | | 24.2519-1706.3 | 040096 | NEHMERZYLINDER | 6Q0 721 261 F , 6Q0 721 261 D , 6QE 721 261 , 5Q0 721 261 , 1U0 721 261 A , 6Q0 721 261 A |
| | | 3) Coull | 04.2011 | | 24.2519-1706.3 | 040096 | NEHMERZYLINDER | 6Q0 721 261 F , 6Q0 721 261 D , 6QE 721 261 , 5Q0 721 261 , 1U0 721 261 A , 6Q0 721 261 A |
| LUPO (98-05) | 1,6 GTI | 3) Coull | 09.2000 | 08.2005 | 24.2519-1706.3 | 040096 | NEHMERZYLINDER | 6Q0 721 261 F , 6Q0 721 261 D , 6QE 721 261 , 5Q0 721 261 , 1U0 721 261 A , 6Q0 721 261 A |
| PASSAT / PASSAT VARIANT (10-) | 1,4 TSI | 3) Coull | 11.2012 | | 24.2519-1706.3 | 040096 | NEHMERZYLINDER | 6Q0 721 261 F , 6Q0 721 261 D , 6QE 721 261 , 5Q0 721 261 , 1U0 721 261 A , 6Q0 721 261 A |
| | | 3) Coull | 08.2010 | | 24.2519-1706.3 | 040096 | NEHMERZYLINDER | 6Q0 721 261 F , 6Q0 721 261 D , 6QE 721 261 , 5Q0 721 261 , 1U0 721 261 A , 6Q0 721 261 A |
| | 1,6 TDI | 3) Coull | 08.2010 | | 24.2519-1706.3 | 040096 | NEHMERZYLINDER | 6Q0 721 261 F , 6Q0 721 261 D , 6QE 721 261 , 5Q0 721 261 , 1U0 721 261 A , 6Q0 721 261 A |



| | | | | | | | |
|--|----------|--|--|--|--------------------|---|--|
| | i | | | | Bezeichnung | OE-Nummern zu ATE Artikelnummern | i z.B. Vorsachnummern / diverse |
|--|----------|--|--|--|--------------------|---|--|

VOLKSWAGEN

| | | | | | | | | |
|-------------------------------|-----------------|----------|---------|--|----------------|--------|----------------|---|
| PASSAT / PASSAT VARIANT (10-) | 1,8 TSI | 3) Coull | 08.2010 | | 24.2519-1706.3 | 040096 | NEHMERZYLINDER | 6Q0 721 261 F , 6Q0 721 261 D , 6QE 721 261 , 5Q0 721 261 , 1U0 721 261 A , 6Q0 721 261 A |
| | 2,0 TDI | 3) Coull | 08.2010 | | 24.2519-1706.3 | 040096 | NEHMERZYLINDER | 6Q0 721 261 F , 6Q0 721 261 D , 6QE 721 261 , 5Q0 721 261 , 1U0 721 261 A , 6Q0 721 261 A |
| | | 3) Coull | 12.2012 | | 24.2519-1706.3 | 040096 | NEHMERZYLINDER | 6Q0 721 261 F , 6Q0 721 261 D , 6QE 721 261 , 5Q0 721 261 , 1U0 721 261 A , 6Q0 721 261 A |
| | 2,0 TDI 4motion | 3) Coull | 01.2013 | | 24.2519-1706.3 | 040096 | NEHMERZYLINDER | 6Q0 721 261 F , 6Q0 721 261 D , 6QE 721 261 , 5Q0 721 261 , 1U0 721 261 A , 6Q0 721 261 A |
| | | 3) Coull | 08.2010 | | 24.2519-1706.3 | 040096 | NEHMERZYLINDER | 6Q0 721 261 F , 6Q0 721 261 D , 6QE 721 261 , 5Q0 721 261 , 1U0 721 261 A , 6Q0 721 261 A |
| | 2,0 TSI | 3) Coull | 11.2010 | | 24.2519-1706.3 | 040096 | NEHMERZYLINDER | 6Q0 721 261 F , 6Q0 721 261 D , 6QE 721 261 , 5Q0 721 261 , 1U0 721 261 A , 6Q0 721 261 A |
| | 2,0 TSI 4motion | 3) Coull | 01.2012 | | 24.2519-1706.3 | 040096 | NEHMERZYLINDER | 6Q0 721 261 F , 6Q0 721 261 D , 6QE 721 261 , 5Q0 721 261 , 1U0 721 261 A , 6Q0 721 261 A |
| | 3,6 FSI 4motion | 3) Coull | 01.2011 | | 24.2519-1706.3 | 040096 | NEHMERZYLINDER | 6Q0 721 261 F , 6Q0 721 261 D , 6QE 721 261 , 5Q0 721 261 , 1U0 721 261 A , 6Q0 721 261 A |
| PASSAT ALLTRACK (12-) | 1,8 TSI | 3) Coull | 01.2012 | | 24.2519-1706.3 | 040096 | NEHMERZYLINDER | 6Q0 721 261 F , 6Q0 721 261 D , 6QE 721 261 , 5Q0 721 261 , 1U0 721 261 A , 6Q0 721 261 A |



| | | | | | | | |
|--|----------|--|--|--|--------------------|---|--|
| | i | | | | Bezeichnung | OE-Nummern zu ATE Artikelnummern | i z.B. Vorsachnummern / diverse |
|--|----------|--|--|--|--------------------|---|--|

VOLKSWAGEN

| | | | | | | | | |
|--------------------------|-----------------|----------|---------|---------|----------------|--------|----------------|--|
| PASSAT ALLTRACK (12-) | 2,0 TDI | 3) Coull | 01.2012 | | 24.2519-1706.3 | 040096 | NEHMERZYLINDER | 6Q0 721 261 F, 6Q0 721 261 D, 6QE 721 261, 5Q0 721 261, 1U0 721 261 A, 6Q0 721 261 A |
| | 2,0 TDI 4motion | 3) Coull | 01.2013 | | 24.2519-1706.3 | 040096 | NEHMERZYLINDER | 6Q0 721 261 F, 6Q0 721 261 D, 6QE 721 261, 5Q0 721 261, 1U0 721 261 A, 6Q0 721 261 A |
| | | 3) Coull | 01.2012 | | 24.2519-1706.3 | 040096 | NEHMERZYLINDER | 6Q0 721 261 F, 6Q0 721 261 D, 6QE 721 261, 5Q0 721 261, 1U0 721 261 A, 6Q0 721 261 A |
| | 2,0 TSI 4motion | 3) Coull | 01.2012 | | 24.2519-1706.3 | 040096 | NEHMERZYLINDER | 6Q0 721 261 F, 6Q0 721 261 D, 6QE 721 261, 5Q0 721 261, 1U0 721 261 A, 6Q0 721 261 A |
| PASSAT Limousine (05-10) | 1,4 TSI | 3) Coull | 10.2007 | 07.2010 | 24.2519-1706.3 | 040096 | NEHMERZYLINDER | 6Q0 721 261 F, 6Q0 721 261 D, 6QE 721 261, 5Q0 721 261, 1U0 721 261 A, 6Q0 721 261 A |
| | 1,6 | 3) Coull | 03.2005 | 07.2010 | 24.2519-1706.3 | 040096 | NEHMERZYLINDER | 6Q0 721 261 F, 6Q0 721 261 D, 6QE 721 261, 5Q0 721 261, 1U0 721 261 A, 6Q0 721 261 A |
| | 1,6 FSI | 3) Coull | 03.2005 | 07.2010 | 24.2519-1706.3 | 040096 | NEHMERZYLINDER | 6Q0 721 261 F, 6Q0 721 261 D, 6QE 721 261, 5Q0 721 261, 1U0 721 261 A, 6Q0 721 261 A |
| | 1,6 TDI | 3) Coull | 08.2009 | 07.2010 | 24.2519-1706.3 | 040096 | NEHMERZYLINDER | 6Q0 721 261 F, 6Q0 721 261 D, 6QE 721 261, 5Q0 721 261, 1U0 721 261 A, 6Q0 721 261 A |
| | 1,8 TSI | 3) Coull | 11.2009 | 07.2010 | 24.2519-1706.3 | 040096 | NEHMERZYLINDER | 6Q0 721 261 F, 6Q0 721 261 D, 6QE 721 261, 5Q0 721 261, 1U0 721 261 A, 6Q0 721 261 A |



| | | | | | | | |
|--|----------|--|--|--|--------------------|---|--|
| | i | | | | Bezeichnung | OE-Nummern zu ATE Artikelnummern | i z.B. Vorsachnummern / diverse |
|--|----------|--|--|--|--------------------|---|--|

VOLKSWAGEN

| | | | | | | | | |
|--------------------------|-----------------|----------|---------|---------|----------------|--------|----------------|--|
| PASSAT Limousine (05-10) | 1,8 TSI | 3) Coull | 10.2007 | 07.2010 | 24.2519-1706.3 | 040096 | NEHMERZYLINDER | 6Q0 721 261 F, 6Q0 721 261 D, 6QE 721 261, 5Q0 721 261, 1U0 721 261 A, 6Q0 721 261 A |
| | 1,9 TDI | 3) Coull | 03.2005 | 07.2010 | 24.2519-1706.3 | 040096 | NEHMERZYLINDER | 6Q0 721 261 F, 6Q0 721 261 D, 6QE 721 261, 5Q0 721 261, 1U0 721 261 A, 6Q0 721 261 A |
| | 2,0 FSI | 3) Coull | 03.2005 | 07.2010 | 24.2519-1706.3 | 040096 | NEHMERZYLINDER | 6Q0 721 261 F, 6Q0 721 261 D, 6QE 721 261, 5Q0 721 261, 1U0 721 261 A, 6Q0 721 261 A |
| | 2,0 FSI 4motion | 3) Coull | 03.2005 | 07.2010 | 24.2519-1706.3 | 040096 | NEHMERZYLINDER | 6Q0 721 261 F, 6Q0 721 261 D, 6QE 721 261, 5Q0 721 261, 1U0 721 261 A, 6Q0 721 261 A |
| | 2,0 TDI | 3) Coull | 03.2005 | 07.2010 | 24.2519-1706.3 | 040096 | NEHMERZYLINDER | 6Q0 721 261 F, 6Q0 721 261 D, 6QE 721 261, 5Q0 721 261, 1U0 721 261 A, 6Q0 721 261 A |
| | | 3) Coull | 08.2005 | 07.2010 | 24.2519-1706.3 | 040096 | NEHMERZYLINDER | 6Q0 721 261 F, 6Q0 721 261 D, 6QE 721 261, 5Q0 721 261, 1U0 721 261 A, 6Q0 721 261 A |
| | 2,0 TDI 16V | 3) Coull | 03.2005 | 07.2010 | 24.2519-1706.3 | 040096 | NEHMERZYLINDER | 6Q0 721 261 F, 6Q0 721 261 D, 6QE 721 261, 5Q0 721 261, 1U0 721 261 A, 6Q0 721 261 A |
| | 2,0 TDI 4motion | 3) Coull | 03.2005 | 07.2010 | 24.2519-1706.3 | 040096 | NEHMERZYLINDER | 6Q0 721 261 F, 6Q0 721 261 D, 6QE 721 261, 5Q0 721 261, 1U0 721 261 A, 6Q0 721 261 A |
| | | 3) Coull | 05.2009 | 07.2010 | 24.2519-1706.3 | 040096 | NEHMERZYLINDER | 6Q0 721 261 F, 6Q0 721 261 D, 6QE 721 261, 5Q0 721 261, 1U0 721 261 A, 6Q0 721 261 A |



| | | | | | | | |
|--|----------|--|--|--|--------------------|---|--|
| | i | | | | Bezeichnung | OE-Nummern zu ATE Artikelnummern | i z.B. Vorsachnummern / diverse |
|--|----------|--|--|--|--------------------|---|--|

VOLKSWAGEN

| | | | | | | | | |
|--------------------------|--------------------|----------|---------|---------|----------------|--------|----------------|--|
| PASSAT Limousine (05-10) | 2,0 TFSI | 3) Coull | 03.2005 | 07.2010 | 24.2519-1706.3 | 040096 | NEHMERZYLINDER | 6Q0 721 261 F, 6Q0 721 261 D, 6QE 721 261, 5Q0 721 261, 1U0 721 261 A, 6Q0 721 261 A |
| | 3,2 V6 FSI | 3) Coull | 11.2005 | 07.2010 | 24.2519-1706.3 | 040096 | NEHMERZYLINDER | 6Q0 721 261 F, 6Q0 721 261 D, 6QE 721 261, 5Q0 721 261, 1U0 721 261 A, 6Q0 721 261 A |
| | 3,2 V6 FSI 4motion | 3) Coull | 09.2005 | 07.2010 | 24.2519-1706.3 | 040096 | NEHMERZYLINDER | 6Q0 721 261 F, 6Q0 721 261 D, 6QE 721 261, 5Q0 721 261, 1U0 721 261 A, 6Q0 721 261 A |
| | 3,6 R36 | 3) Coull | 04.2007 | 07.2010 | 24.2519-1706.3 | 040096 | NEHMERZYLINDER | 6Q0 721 261 F, 6Q0 721 261 D, 6QE 721 261, 5Q0 721 261, 1U0 721 261 A, 6Q0 721 261 A |
| PASSAT Variant (05-10) | 1,4 TSI | 3) Coull | 10.2007 | 07.2010 | 24.2519-1706.3 | 040096 | NEHMERZYLINDER | 6Q0 721 261 F, 6Q0 721 261 D, 6QE 721 261, 5Q0 721 261, 1U0 721 261 A, 6Q0 721 261 A |
| | 1,6 | 3) Coull | 07.2005 | 07.2010 | 24.2519-1706.3 | 040096 | NEHMERZYLINDER | 6Q0 721 261 F, 6Q0 721 261 D, 6QE 721 261, 5Q0 721 261, 1U0 721 261 A, 6Q0 721 261 A |
| | 1,6 FSI | 3) Coull | 07.2005 | 07.2010 | 24.2519-1706.3 | 040096 | NEHMERZYLINDER | 6Q0 721 261 F, 6Q0 721 261 D, 6QE 721 261, 5Q0 721 261, 1U0 721 261 A, 6Q0 721 261 A |
| | 1,6 TDI | 3) Coull | 08.2009 | 07.2010 | 24.2519-1706.3 | 040096 | NEHMERZYLINDER | 6Q0 721 261 F, 6Q0 721 261 D, 6QE 721 261, 5Q0 721 261, 1U0 721 261 A, 6Q0 721 261 A |
| | 1,8 TSI | 3) Coull | 10.2007 | 07.2010 | 24.2519-1706.3 | 040096 | NEHMERZYLINDER | 6Q0 721 261 F, 6Q0 721 261 D, 6QE 721 261, 5Q0 721 261, 1U0 721 261 A, 6Q0 721 261 A |



Bezeichnung

OE-Nummern
zu ATE
Artikelnummern



z.B. Vorsachnummern /
diverse

VOLKSWAGEN

| PASSAT Variant (05-10) | 1,8 TSI | 3) Coull | 11.2009 | 07.2010 | 24.2519-1706.3 | 040096 | NEHMERZYLINDER | 6Q0 721 261 F , 6Q0 721 261 D , 6QE 721 261 , 5Q0 721 261 , 1U0 721 261 A , 6Q0 721 261 A |
|------------------------|-----------------|----------|---------|---------|----------------|--------|----------------|---|
| | 1,9 TDI | 3) Coull | 07.2005 | 07.2010 | 24.2519-1706.3 | 040096 | NEHMERZYLINDER | 6Q0 721 261 F , 6Q0 721 261 D , 6QE 721 261 , 5Q0 721 261 , 1U0 721 261 A , 6Q0 721 261 A |
| | 2,0 FSI | 3) Coull | 07.2005 | 07.2010 | 24.2519-1706.3 | 040096 | NEHMERZYLINDER | 6Q0 721 261 F , 6Q0 721 261 D , 6QE 721 261 , 5Q0 721 261 , 1U0 721 261 A , 6Q0 721 261 A |
| | 2,0 FSI 4motion | 3) Coull | 09.2005 | 07.2010 | 24.2519-1706.3 | 040096 | NEHMERZYLINDER | 6Q0 721 261 F , 6Q0 721 261 D , 6QE 721 261 , 5Q0 721 261 , 1U0 721 261 A , 6Q0 721 261 A |
| | 2,0 TDI | 3) Coull | 07.2005 | 07.2010 | 24.2519-1706.3 | 040096 | NEHMERZYLINDER | 6Q0 721 261 F , 6Q0 721 261 D , 6QE 721 261 , 5Q0 721 261 , 1U0 721 261 A , 6Q0 721 261 A |
| | | 3) Coull | 11.2005 | 07.2010 | 24.2519-1706.3 | 040096 | NEHMERZYLINDER | 6Q0 721 261 F , 6Q0 721 261 D , 6QE 721 261 , 5Q0 721 261 , 1U0 721 261 A , 6Q0 721 261 A |
| | 2,0 TDI 16V | 3) Coull | 08.2005 | 07.2010 | 24.2519-1706.3 | 040096 | NEHMERZYLINDER | 6Q0 721 261 F , 6Q0 721 261 D , 6QE 721 261 , 5Q0 721 261 , 1U0 721 261 A , 6Q0 721 261 A |
| | 2,0 TDI 4motion | 3) Coull | 05.2009 | 07.2010 | 24.2519-1706.3 | 040096 | NEHMERZYLINDER | 6Q0 721 261 F , 6Q0 721 261 D , 6QE 721 261 , 5Q0 721 261 , 1U0 721 261 A , 6Q0 721 261 A |
| | | 3) Coull | 09.2005 | 07.2010 | 24.2519-1706.3 | 040096 | NEHMERZYLINDER | 6Q0 721 261 F , 6Q0 721 261 D , 6QE 721 261 , 5Q0 721 261 , 1U0 721 261 A , 6Q0 721 261 A |



Bezeichnung

OE-Nummern
zu ATE
Artikelnummern



z.B. Vorsachnummern /
diverse

VOLKSWAGEN

| Modell | Motor | 3) Coull | 07.2005 | 07.2010 | 24.2519-1706.3 | 040096 | Bezeichnung | OE-Nummern zu ATE Artikelnummern | z.B. Vorsachnummern / diverse |
|------------------------|--------------------|----------|---------|---------|----------------|--------|----------------|--|-------------------------------|
| PASSAT Variant (05-10) | 2,0 TFSI | 3) Coull | 07.2005 | 07.2010 | 24.2519-1706.3 | 040096 | NEHMERZYLINDER | 6Q0 721 261 F, 6Q0 721 261 D, 6QE 721 261, 5Q0 721 261, 1U0 721 261 A, 6Q0 721 261 A | |
| | 3,2 V6 FSI | 3) Coull | 11.2005 | 07.2010 | 24.2519-1706.3 | 040096 | NEHMERZYLINDER | 6Q0 721 261 F, 6Q0 721 261 D, 6QE 721 261, 5Q0 721 261, 1U0 721 261 A, 6Q0 721 261 A | |
| | 3,2 V6 FSI 4motion | 3) Coull | 09.2005 | 07.2010 | 24.2519-1706.3 | 040096 | NEHMERZYLINDER | 6Q0 721 261 F, 6Q0 721 261 D, 6QE 721 261, 5Q0 721 261, 1U0 721 261 A, 6Q0 721 261 A | |
| | 3,6 R36 | 3) Coull | 04.2007 | 07.2010 | 24.2519-1706.3 | 040096 | NEHMERZYLINDER | 6Q0 721 261 F, 6Q0 721 261 D, 6QE 721 261, 5Q0 721 261, 1U0 721 261 A, 6Q0 721 261 A | |
| POLO IV (02-09) | 1,2 | 3) Coull | 11.2001 | 05.2009 | 24.2519-1706.3 | 040096 | NEHMERZYLINDER | 6Q0 721 261 F, 6Q0 721 261 D, 6QE 721 261, 5Q0 721 261, 1U0 721 261 A, 6Q0 721 261 A | |
| | | 3) Coull | 04.2007 | 05.2009 | 24.2519-1706.3 | 040096 | NEHMERZYLINDER | 6Q0 721 261 F, 6Q0 721 261 D, 6QE 721 261, 5Q0 721 261, 1U0 721 261 A, 6Q0 721 261 A | |
| | 1,4 16V | 3) Coull | 05.2006 | 05.2009 | 24.2519-1706.3 | 040096 | NEHMERZYLINDER | 6Q0 721 261 F, 6Q0 721 261 D, 6QE 721 261, 5Q0 721 261, 1U0 721 261 A, 6Q0 721 261 A | |
| | | 3) Coull | 11.2001 | 05.2009 | 24.2519-1706.3 | 040096 | NEHMERZYLINDER | 6Q0 721 261 F, 6Q0 721 261 D, 6QE 721 261, 5Q0 721 261, 1U0 721 261 A, 6Q0 721 261 A | |
| | 1,4 FSI | 3) Coull | 11.2001 | 05.2009 | 24.2519-1706.3 | 040096 | NEHMERZYLINDER | 6Q0 721 261 F, 6Q0 721 261 D, 6QE 721 261, 5Q0 721 261, 1U0 721 261 A, 6Q0 721 261 A | |



Bezeichnung

OE-Nummern
zu ATE
Artikelnummern



z.B. Vorsachnummern /
diverse

VOLKSWAGEN

| | | | | | | | | | |
|-----------------|---------|----------|---------|---------|----------------|--------|----------------|--|--|
| POLO IV (02-09) | 1,4 TDI | 3) Coull | 11.2001 | 05.2009 | 24.2519-1706.3 | 040096 | NEHMERZYLINDER | 6Q0 721 261 F, 6Q0 721 261 D, 6QE 721 261, 5Q0 721 261, 1U0 721 261 A, 6Q0 721 261 A | |
| | 1,6 16V | 3) Coull | 05.2006 | 05.2009 | 24.2519-1706.3 | 040096 | NEHMERZYLINDER | 6Q0 721 261 F, 6Q0 721 261 D, 6QE 721 261, 5Q0 721 261, 1U0 721 261 A, 6Q0 721 261 A | |
| | 1,8 GTI | 3) Coull | 06.2006 | 05.2009 | 24.2519-1706.3 | 040096 | NEHMERZYLINDER | 6Q0 721 261 F, 6Q0 721 261 D, 6QE 721 261, 5Q0 721 261, 1U0 721 261 A, 6Q0 721 261 A | |
| | | 3) Coull | 09.2005 | 05.2009 | 24.2519-1706.3 | 040096 | NEHMERZYLINDER | 6Q0 721 261 F, 6Q0 721 261 D, 6QE 721 261, 5Q0 721 261, 1U0 721 261 A, 6Q0 721 261 A | |
| | 1,9 SDI | 3) Coull | 11.2001 | 05.2009 | 24.2519-1706.3 | 040096 | NEHMERZYLINDER | 6Q0 721 261 F, 6Q0 721 261 D, 6QE 721 261, 5Q0 721 261, 1U0 721 261 A, 6Q0 721 261 A | |
| | 1,9 TDI | 3) Coull | 10.2003 | 05.2009 | 24.2519-1706.3 | 040096 | NEHMERZYLINDER | 6Q0 721 261 F, 6Q0 721 261 D, 6QE 721 261, 5Q0 721 261, 1U0 721 261 A, 6Q0 721 261 A | |
| | | 3) Coull | 11.2001 | 05.2009 | 24.2519-1706.3 | 040096 | NEHMERZYLINDER | 6Q0 721 261 F, 6Q0 721 261 D, 6QE 721 261, 5Q0 721 261, 1U0 721 261 A, 6Q0 721 261 A | |
| | 2 | 3) Coull | 04.2002 | 05.2009 | 24.2519-1706.3 | 040096 | NEHMERZYLINDER | 6Q0 721 261 F, 6Q0 721 261 D, 6QE 721 261, 5Q0 721 261, 1U0 721 261 A, 6Q0 721 261 A | |
| POLO V (09-) | 1 | 3) Coull | 01.2014 | | 24.2519-1706.3 | 040096 | NEHMERZYLINDER | 6Q0 721 261 F, 6Q0 721 261 D, 6QE 721 261, 5Q0 721 261, 1U0 721 261 A, 6Q0 721 261 A | |



| | | | | | | |
|--|----------|--|--|--------------------|---|--|
| | i | | | Bezeichnung | OE-Nummern zu ATE Artikelnummern | i z.B. Vorsachnummern / diverse |
|--|----------|--|--|--------------------|---|--|

VOLKSWAGEN

| | | | | | | | |
|--------------|------------|----------|---------|----------------|--------|----------------|--|
| POLO V (09-) | 1,2 | 3) Coull | 03.2009 | 24.2519-1706.3 | 040096 | NEHMERZYLINDER | 6Q0 721 261 F, 6Q0 721 261 D, 6QE 721 261, 5Q0 721 261, 1U0 721 261 A, 6Q0 721 261 A |
| | 1,2 TDI | 3) Coull | 10.2009 | 24.2519-1706.3 | 040096 | NEHMERZYLINDER | 6Q0 721 261 F, 6Q0 721 261 D, 6QE 721 261, 5Q0 721 261, 1U0 721 261 A, 6Q0 721 261 A |
| | 1,2 TSI | 3) Coull | 05.2011 | 24.2519-1706.3 | 040096 | NEHMERZYLINDER | 6Q0 721 261 F, 6Q0 721 261 D, 6QE 721 261, 5Q0 721 261, 1U0 721 261 A, 6Q0 721 261 A |
| | | 3) Coull | 06.2009 | 24.2519-1706.3 | 040096 | NEHMERZYLINDER | 6Q0 721 261 F, 6Q0 721 261 D, 6QE 721 261, 5Q0 721 261, 1U0 721 261 A, 6Q0 721 261 A |
| | 1,4 | 3) Coull | 03.2009 | 24.2519-1706.3 | 040096 | NEHMERZYLINDER | 6Q0 721 261 F, 6Q0 721 261 D, 6QE 721 261, 5Q0 721 261, 1U0 721 261 A, 6Q0 721 261 A |
| | 1,4 BiFuel | 3) Coull | 03.2010 | 24.2519-1706.3 | 040096 | NEHMERZYLINDER | 6Q0 721 261 F, 6Q0 721 261 D, 6QE 721 261, 5Q0 721 261, 1U0 721 261 A, 6Q0 721 261 A |
| | 1,4 GTI | 3) Coull | 05.2010 | 24.2519-1706.3 | 040096 | NEHMERZYLINDER | 6Q0 721 261 F, 6Q0 721 261 D, 6QE 721 261, 5Q0 721 261, 1U0 721 261 A, 6Q0 721 261 A |
| | 1,4 TSI | 3) Coull | 10.2012 | 24.2519-1706.3 | 040096 | NEHMERZYLINDER | 6Q0 721 261 F, 6Q0 721 261 D, 6QE 721 261, 5Q0 721 261, 1U0 721 261 A, 6Q0 721 261 A |
| | 1,6 BiFuel | 3) Coull | 01.2011 | 24.2519-1706.3 | 040096 | NEHMERZYLINDER | 6Q0 721 261 F, 6Q0 721 261 D, 6QE 721 261, 5Q0 721 261, 1U0 721 261 A, 6Q0 721 261 A |



| | | | | | | | |
|--|--|--|--|--|--------------------|---|-----------------------------------|
| | | | | | Bezeichnung | OE-Nummern zu ATE Artikelnummern | z.B. Vorsachnummern / diverse |
|--|--|--|--|--|--------------------|---|-----------------------------------|

VOLKSWAGEN

| | | | | | | | | |
|----------------|-----------|----------|---------|--|----------------|--------|----------------|--|
| POLO V (09-) | 1,6 TDI | 3) Coull | 03.2009 | | 24.2519-1706.3 | 040096 | NEHMERZYLINDER | 6Q0 721 261 F, 6Q0 721 261 D, 6QE 721 261, 5Q0 721 261, 1U0 721 261 A, 6Q0 721 261 A |
| | | 3) Coull | 06.2009 | | 24.2519-1706.3 | 040096 | NEHMERZYLINDER | 6Q0 721 261 F, 6Q0 721 261 D, 6QE 721 261, 5Q0 721 261, 1U0 721 261 A, 6Q0 721 261 A |
| | 2,0 R WRC | 3) Coull | 08.2013 | | 24.2519-1706.3 | 040096 | NEHMERZYLINDER | 6Q0 721 261 F, 6Q0 721 261 D, 6QE 721 261, 5Q0 721 261, 1U0 721 261 A, 6Q0 721 261 A |
| SCIROCCO (08-) | 1,4 TSI | 3) Coull | 09.2008 | | 24.2519-1706.3 | 040096 | NEHMERZYLINDER | 6Q0 721 261 F, 6Q0 721 261 D, 6QE 721 261, 5Q0 721 261, 1U0 721 261 A, 6Q0 721 261 A |
| | | 3) Coull | 08.2008 | | 24.2519-1706.3 | 040096 | NEHMERZYLINDER | 6Q0 721 261 F, 6Q0 721 261 D, 6QE 721 261, 5Q0 721 261, 1U0 721 261 A, 6Q0 721 261 A |
| | 2,0 R | 3) Coull | 11.2009 | | 24.2519-1706.3 | 040096 | NEHMERZYLINDER | 6Q0 721 261 F, 6Q0 721 261 D, 6QE 721 261, 5Q0 721 261, 1U0 721 261 A, 6Q0 721 261 A |
| | | 3) Coull | 08.2014 | | 24.2519-1706.3 | 040096 | NEHMERZYLINDER | 6Q0 721 261 F, 6Q0 721 261 D, 6QE 721 261, 5Q0 721 261, 1U0 721 261 A, 6Q0 721 261 A |
| | 2,0 TDI | 3) Coull | 01.2013 | | 24.2519-1706.3 | 040096 | NEHMERZYLINDER | 6Q0 721 261 F, 6Q0 721 261 D, 6QE 721 261, 5Q0 721 261, 1U0 721 261 A, 6Q0 721 261 A |
| | | 3) Coull | 05.2009 | | 24.2519-1706.3 | 040096 | NEHMERZYLINDER | 6Q0 721 261 F, 6Q0 721 261 D, 6QE 721 261, 5Q0 721 261, 1U0 721 261 A, 6Q0 721 261 A |



| | | | | | | | |
|--|----------|--|--|--|--------------------|---|--|
| | i | | | | Bezeichnung | OE-Nummern zu ATE Artikelnummern | i z.B. Vorsachnummern / diverse |
|--|----------|--|--|--|--------------------|---|--|

VOLKSWAGEN

| | | | | | | | | | |
|-------------------|----------------|----------|---------|---------|----------------|--------|----------------|---|----------------|
| SCIROCCO (08-) | 2,0 TDI | 3) Coull | 10.2008 | | 24.2519-1706.3 | 040096 | NEHMERZYLINDER | 6Q0 721 261 F , 6Q0 721 261 D , 6QE 721 261 , 5Q0 721 261 , 1U0 721 261 A , 6Q0 721 261 A | |
| | 2,0 TSI | 3) Coull | 08.2008 | | 24.2519-1706.3 | 040096 | NEHMERZYLINDER | 6Q0 721 261 F , 6Q0 721 261 D , 6QE 721 261 , 5Q0 721 261 , 1U0 721 261 A , 6Q0 721 261 A | |
| | | 3) Coull | 08.2014 | | 24.2519-1706.3 | 040096 | NEHMERZYLINDER | 6Q0 721 261 F , 6Q0 721 261 D , 6QE 721 261 , 5Q0 721 261 , 1U0 721 261 A , 6Q0 721 261 A | |
| | | 3) Coull | 11.2009 | | 24.2519-1706.3 | 040096 | NEHMERZYLINDER | 6Q0 721 261 F , 6Q0 721 261 D , 6QE 721 261 , 5Q0 721 261 , 1U0 721 261 A , 6Q0 721 261 A | |
| SHARAN I (95-10) | 1,8 T | 3) Coull | 09.1997 | | 24.5166-0454.3 | 331306 | BREMSSCHLAUCH | 1001348 , 95VW-2078-AE , 7335771 , 7M0 611 701 D | 83.7717-0450.3 |
| | 1,9 TDI | 3) Coull | 05.2000 | | 24.5166-0454.3 | 331306 | BREMSSCHLAUCH | 1001348 , 95VW-2078-AE , 7335771 , 7M0 611 701 D | 83.7717-0450.3 |
| | | 3) Coull | 09.1995 | | 24.5166-0454.3 | 331306 | BREMSSCHLAUCH | 1001348 , 95VW-2078-AE , 7335771 , 7M0 611 701 D | 83.7717-0450.3 |
| | | 3) Coull | 09.1996 | 04.2000 | 24.5166-0454.3 | 331306 | BREMSSCHLAUCH | 1001348 , 95VW-2078-AE , 7335771 , 7M0 611 701 D | 83.7717-0450.3 |
| | 2 | 3) Coull | 09.1995 | | 24.5166-0454.3 | 331306 | BREMSSCHLAUCH | 1001348 , 95VW-2078-AE , 7335771 , 7M0 611 701 D | 83.7717-0450.3 |
| | 2,8 VR6 | 3) Coull | 09.1995 | 04.2000 | 24.5166-0454.3 | 331306 | BREMSSCHLAUCH | 1001348 , 95VW-2078-AE , 7335771 , 7M0 611 701 D | 83.7717-0450.3 |
| | 2,8 VR6 Syncro | 3) Coull | 11.1996 | 04.2000 | 24.5166-0454.3 | 331306 | BREMSSCHLAUCH | 1001348 , 95VW-2078-AE , 7335771 , 7M0 611 701 D | 83.7717-0450.3 |
| TOUAREG I (03-10) | 2,5 R5 TDI | VR | 01.2003 | 03.2010 | 11.9601-9948.2 | 220904 | FAUSTSATTEL | 7H0 615 124 A , 7L6 615 124 F | 11.9601-8502.2 |



| | | | | | | | |
|--|----------|--|--|--|--------------------|---|--|
| | i | | | | Bezeichnung | OE-Nummern zu ATE Artikelnummern | i z.B. Vorsachnummern / diverse |
|--|----------|--|--|--|--------------------|---|--|

VOLKSWAGEN

| | | | | | | | | | |
|-------------------|-----------------|----------|---------|---------|----------------|--------|----------------|---|----------------|
| TOUAREG I (03-10) | 3,0 V6 TDI | VR | 11.2004 | 03.2010 | 11.9601-9948.2 | 220904 | FAUSTSATTEL | 7H0 615 124 A , 7L6 615 124 F | 11.9601-8502.2 |
| | | VR | 10.2007 | 03.2010 | 11.9601-9948.2 | 220904 | FAUSTSATTEL | 7H0 615 124 A , 7L6 615 124 F | 11.9601-8502.2 |
| | 3,2 V6 | VR | 11.2002 | 12.2005 | 11.9601-9948.2 | 220904 | FAUSTSATTEL | 7H0 615 124 A , 7L6 615 124 F | 11.9601-8502.2 |
| | 3,6 V6 FSI | VR | 01.2006 | 03.2010 | 11.9601-9948.2 | 220904 | FAUSTSATTEL | 7H0 615 124 A , 7L6 615 124 F | 11.9601-8502.2 |
| | 4,2 V8 | VR | 12.2002 | 11.2006 | 11.9601-9948.2 | 220904 | FAUSTSATTEL | 7H0 615 124 A , 7L6 615 124 F | 11.9601-8502.2 |
| | 4,2 V8 FSI | VR | 12.2006 | 03.2010 | 11.9601-9948.2 | 220904 | FAUSTSATTEL | 7H0 615 124 A , 7L6 615 124 F | 11.9601-8502.2 |
| | 5,0 TDI R50 | VR | 01.2008 | 03.2010 | 11.9601-9948.2 | 220904 | FAUSTSATTEL | 7H0 615 124 A , 7L6 615 124 F | 11.9601-8502.2 |
| | 5,0 V10 TDI | VR | 11.2002 | 03.2010 | 11.9601-9948.2 | 220904 | FAUSTSATTEL | 7H0 615 124 A , 7L6 615 124 F | 11.9601-8502.2 |
| | 6,0 W12 | VR | 08.2004 | 11.2006 | 11.9601-9948.2 | 220904 | FAUSTSATTEL | 7H0 615 124 A , 7L6 615 124 F | 11.9601-8502.2 |
| TOURAN (03-) | 1,2 TSI | 3) Coull | 05.2010 | | 24.2519-1706.3 | 040096 | NEHMERZYLINDER | 6Q0 721 261 F , 6Q0 721 261 D , 6QE 721 261 , 5Q0 721 261 , 1U0 721 261 A , 6Q0 721 261 A | |
| | 1,4 TSI | 3) Coull | 11.2009 | | 24.2519-1706.3 | 040096 | NEHMERZYLINDER | 6Q0 721 261 F , 6Q0 721 261 D , 6QE 721 261 , 5Q0 721 261 , 1U0 721 261 A , 6Q0 721 261 A | |
| | 1,4 TSI EcoFuel | 3) Coull | 11.2009 | | 24.2519-1706.3 | 040096 | NEHMERZYLINDER | 6Q0 721 261 F , 6Q0 721 261 D , 6QE 721 261 , 5Q0 721 261 , 1U0 721 261 A , 6Q0 721 261 A | |









| | | | | | | | |
|--|----------|--|--|--|--------------------|---|--|
| | i | | | | Bezeichnung | OE-Nummern zu ATE Artikelnummern | i z.B. Vorsachnummern / diverse |
|--|----------|--|--|--|--------------------|---|--|

VOLKSWAGEN

| | | | | | | | | | |
|--|--------------|----------|---------|--|----------------|--------|----------------|---|----------------|
| TOURAN (03-) | 1,6 | 3) Coull | 11.2009 | | 24.2519-1706.3 | 040096 | NEHMERZYLINDER | 6Q0 721 261 F , 6Q0 721 261 D , 6QE 721 261 , 5Q0 721 261 , 1U0 721 261 A , 6Q0 721 261 A | |
| | 1,6 FSI | 3) Coull | 11.2009 | | 24.2519-1706.3 | 040096 | NEHMERZYLINDER | 6Q0 721 261 F , 6Q0 721 261 D , 6QE 721 261 , 5Q0 721 261 , 1U0 721 261 A , 6Q0 721 261 A | |
| | 1,6 TDI | 3) Coull | 05.2010 | | 24.2519-1706.3 | 040096 | NEHMERZYLINDER | 6Q0 721 261 F , 6Q0 721 261 D , 6QE 721 261 , 5Q0 721 261 , 1U0 721 261 A , 6Q0 721 261 A | |
| | 1,9 TDI | 3) Coull | 11.2009 | | 24.2519-1706.3 | 040096 | NEHMERZYLINDER | 6Q0 721 261 F , 6Q0 721 261 D , 6QE 721 261 , 5Q0 721 261 , 1U0 721 261 A , 6Q0 721 261 A | |
| | 2,0 Eco Fuel | 3) Coull | 11.2009 | | 24.2519-1706.3 | 040096 | NEHMERZYLINDER | 6Q0 721 261 F , 6Q0 721 261 D , 6QE 721 261 , 5Q0 721 261 , 1U0 721 261 A , 6Q0 721 261 A | |
| | 2,0 FSI | 3) Coull | 11.2009 | | 24.2519-1706.3 | 040096 | NEHMERZYLINDER | 6Q0 721 261 F , 6Q0 721 261 D , 6QE 721 261 , 5Q0 721 261 , 1U0 721 261 A , 6Q0 721 261 A | |
| | 2,0 TDI | 3) Coull | 01.2013 | | 24.2519-1706.3 | 040096 | NEHMERZYLINDER | 6Q0 721 261 F , 6Q0 721 261 D , 6QE 721 261 , 5Q0 721 261 , 1U0 721 261 A , 6Q0 721 261 A | |
| | | 3) Coull | 11.2009 | | 24.2519-1706.3 | 040096 | NEHMERZYLINDER | 6Q0 721 261 F , 6Q0 721 261 D , 6QE 721 261 , 5Q0 721 261 , 1U0 721 261 A , 6Q0 721 261 A | |
| TRANSPORTER (T5) BUS / MULTIVAN / KASTEN (03-) | 1,9 TDI | VR | 06.2006 | | 11.9601-9948.2 | 220904 | FAUSTSATTEL | 7H0 615 124 A , 7L6 615 124 F | 11.9601-8502.2 |



| | | | | | | | |
|---|---|---|--|---|--------------------|---|---|
|  |  |  |  |  | Bezeichnung | OE-Nummern zu ATE Artikelnummern |  z.B. Vorsachnummern / diverse |
|---|---|---|--|---|--------------------|---|---|

VOLKSWAGEN

| | | | | | | | | | |
|--|-------------------|----|---------|--|----------------|--------|-------------|-------------------------------|----------------|
| TRANSPORTER (T5) BUS / MULTIVAN / KASTEN (03-) | 1,9 TDI | VR | 01.2006 | | 11.9601-9948.2 | 220904 | FAUSTSATTEL | 7H0 615 124 A , 7L6 615 124 F | 11.9601-8502.2 |
| | | VR | 04.2003 | | 11.9601-9948.2 | 220904 | FAUSTSATTEL | 7H0 615 124 A , 7L6 615 124 F | 11.9601-8502.2 |
| | 2 | VR | 06.2003 | | 11.9601-9948.2 | 220904 | FAUSTSATTEL | 7H0 615 124 A , 7L6 615 124 F | 11.9601-8502.2 |
| | 2,0 BiTDI | VR | 09.2009 | | 11.9601-9948.2 | 220904 | FAUSTSATTEL | 7H0 615 124 A , 7L6 615 124 F | 11.9601-8502.2 |
| | 2,0 BiTDI 4motion | VR | 09.2009 | | 11.9601-9948.2 | 220904 | FAUSTSATTEL | 7H0 615 124 A , 7L6 615 124 F | 11.9601-8502.2 |
| | 2,0 TDI | VR | 05.2010 | | 11.9601-9948.2 | 220904 | FAUSTSATTEL | 7H0 615 124 A , 7L6 615 124 F | 11.9601-8502.2 |
| | | VR | 05.2011 | | 11.9601-9948.2 | 220904 | FAUSTSATTEL | 7H0 615 124 A , 7L6 615 124 F | 11.9601-8502.2 |
| | | VR | 09.2009 | | 11.9601-9948.2 | 220904 | FAUSTSATTEL | 7H0 615 124 A , 7L6 615 124 F | 11.9601-8502.2 |
| | 2,0 TDI 4motion | VR | 05.2010 | | 11.9601-9948.2 | 220904 | FAUSTSATTEL | 7H0 615 124 A , 7L6 615 124 F | 11.9601-8502.2 |
| | | VR | 09.2009 | | 11.9601-9948.2 | 220904 | FAUSTSATTEL | 7H0 615 124 A , 7L6 615 124 F | 11.9601-8502.2 |
| | 2,0 TSI | VR | 05.2011 | | 11.9601-9948.2 | 220904 | FAUSTSATTEL | 7H0 615 124 A , 7L6 615 124 F | 11.9601-8502.2 |
| | 2,0 TSI 4motion | VR | 07.2011 | | 11.9601-9948.2 | 220904 | FAUSTSATTEL | 7H0 615 124 A , 7L6 615 124 F | 11.9601-8502.2 |
| | 2,5 TDI | VR | 02.2003 | | 11.9601-9948.2 | 220904 | FAUSTSATTEL | 7H0 615 124 A , 7L6 615 124 F | 11.9601-8502.2 |
| | 2,5 TDI 4motion | VR | 07.2004 | | 11.9601-9948.2 | 220904 | FAUSTSATTEL | 7H0 615 124 A , 7L6 615 124 F | 11.9601-8502.2 |







| | | | | | | | |
|--|--|--|--|--|--------------------|---|--------------------------------------|
| | | | | | Bezeichnung | OE-Nummern zu ATE Artikelnummern | z.B. Vorsachnummern / diverse |
|--|--|--|--|--|--------------------|---|--------------------------------------|

VOLKSWAGEN

| | | | | | | | | | |
|--|-------------------|----|---------|--|----------------|--------|-------------|-------------------------------|----------------|
| TRANSPORTER (T5) BUS / MULTIVAN / KASTEN (03-) | 3,2 V6 | VR | 02.2003 | | 11.9601-9948.2 | 220904 | FAUSTSATTEL | 7H0 615 124 A , 7L6 615 124 F | 11.9601-8502.2 |
| | 3,2 V6 4motion | VR | 07.2004 | | 11.9601-9948.2 | 220904 | FAUSTSATTEL | 7H0 615 124 A , 7L6 615 124 F | 11.9601-8502.2 |
| TRANSPORTER (T5) PRITSCHEN / FAHRGESTELL (03-) | 1,9 TDI | VR | 01.2006 | | 11.9601-9948.2 | 220904 | FAUSTSATTEL | 7H0 615 124 A , 7L6 615 124 F | 11.9601-8502.2 |
| | | VR | 04.2003 | | 11.9601-9948.2 | 220904 | FAUSTSATTEL | 7H0 615 124 A , 7L6 615 124 F | 11.9601-8502.2 |
| | | VR | 06.2006 | | 11.9601-9948.2 | 220904 | FAUSTSATTEL | 7H0 615 124 A , 7L6 615 124 F | 11.9601-8502.2 |
| | 2 | VR | 06.2003 | | 11.9601-9948.2 | 220904 | FAUSTSATTEL | 7H0 615 124 A , 7L6 615 124 F | 11.9601-8502.2 |
| | 2,0 BitDI | VR | 09.2009 | | 11.9601-9948.2 | 220904 | FAUSTSATTEL | 7H0 615 124 A , 7L6 615 124 F | 11.9601-8502.2 |
| | 2,0 BitDI 4motion | VR | 09.2009 | | 11.9601-9948.2 | 220904 | FAUSTSATTEL | 7H0 615 124 A , 7L6 615 124 F | 11.9601-8502.2 |
| | 2,0 TDI | VR | 05.2010 | | 11.9601-9948.2 | 220904 | FAUSTSATTEL | 7H0 615 124 A , 7L6 615 124 F | 11.9601-8502.2 |
| | | VR | 05.2011 | | 11.9601-9948.2 | 220904 | FAUSTSATTEL | 7H0 615 124 A , 7L6 615 124 F | 11.9601-8502.2 |
| | | VR | 09.2009 | | 11.9601-9948.2 | 220904 | FAUSTSATTEL | 7H0 615 124 A , 7L6 615 124 F | 11.9601-8502.2 |
| | 2,0 TDI 4motion | VR | 09.2009 | | 11.9601-9948.2 | 220904 | FAUSTSATTEL | 7H0 615 124 A , 7L6 615 124 F | 11.9601-8502.2 |
| | | VR | 05.2010 | | 11.9601-9948.2 | 220904 | FAUSTSATTEL | 7H0 615 124 A , 7L6 615 124 F | 11.9601-8502.2 |
| | 2,0 TSI | VR | 07.2012 | | 11.9601-9948.2 | 220904 | FAUSTSATTEL | 7H0 615 124 A , 7L6 615 124 F | 11.9601-8502.2 |



| | | | | | | | |
|---|---|---|--|---|--------------------|---|---|
|  |  |  |  |  | Bezeichnung | OE-Nummern zu ATE Artikelnummern |  z.B. Vorsachnummern / diverse |
|---|---|---|--|---|--------------------|---|---|

VOLKSWAGEN

| | | | | | | | | | |
|--|-----------------|----|---------|--|----------------|--------|-------------|-------------------------------|----------------|
| TRANSPORTER (T5) PRITSCHEN / FAHRGESTELL (03-) | 2,5 TDI | VR | 02.2003 | | 11.9601-9948.2 | 220904 | FAUSTSATTEL | 7H0 615 124 A , 7L6 615 124 F | 11.9601-8502.2 |
| | 2,5 TDI 4motion | VR | 07.2004 | | 11.9601-9948.2 | 220904 | FAUSTSATTEL | 7H0 615 124 A , 7L6 615 124 F | 11.9601-8502.2 |
| | 3,2 V6 | VR | 02.2004 | | 11.9601-9948.2 | 220904 | FAUSTSATTEL | 7H0 615 124 A , 7L6 615 124 F | 11.9601-8502.2 |
| | | VR | 08.2003 | | 11.9601-9948.2 | 220904 | FAUSTSATTEL | 7H0 615 124 A , 7L6 615 124 F | 11.9601-8502.2 |



Bezeichnung

OE-Nummern
zu ATE
Artikelnummern



z.B. Vorsachnummern /
diverse

VOLVO

| | | | | | | | | | |
|-------------|--------|----------|---------|---------|----------------|--------|---------------|-------------------|----------------|
| 440 (88-96) | 1,6 | 3) Coull | 09.1988 | 12.1996 | 24.5170-0465.3 | 331331 | BREMSSCHLAUCH | 3485043 , 3447432 | 83.6104-0462.3 |
| | 1,7 | 3) Coull | 09.1988 | 12.1996 | 24.5170-0465.3 | 331331 | BREMSSCHLAUCH | 3485043 , 3447432 | 83.6104-0462.3 |
| | | 3) Coull | 08.1989 | 12.1996 | 24.5170-0465.3 | 331331 | BREMSSCHLAUCH | 3485043 , 3447432 | 83.6104-0462.3 |
| | | 3) Coull | 08.1988 | 07.1989 | 24.5170-0465.3 | 331331 | BREMSSCHLAUCH | 3485043 , 3447432 | 83.6104-0462.3 |
| | 1,7 T | 3) Coull | 08.1988 | 07.1996 | 24.5170-0465.3 | 331331 | BREMSSCHLAUCH | 3485043 , 3447432 | 83.6104-0462.3 |
| | | 3) Coull | 01.1991 | 12.1996 | 24.5170-0465.3 | 331331 | BREMSSCHLAUCH | 3485043 , 3447432 | 83.6104-0462.3 |
| | 1,8 | 3) Coull | 08.1991 | 12.1996 | 24.5170-0465.3 | 331331 | BREMSSCHLAUCH | 3485043 , 3447432 | 83.6104-0462.3 |
| | 1,9 TD | 3) Coull | 07.1994 | 12.1996 | 24.5170-0465.3 | 331331 | BREMSSCHLAUCH | 3485043 , 3447432 | 83.6104-0462.3 |
| | 2 | 3) Coull | 08.1993 | 07.1996 | 24.5170-0465.3 | 331331 | BREMSSCHLAUCH | 3485043 , 3447432 | 83.6104-0462.3 |
| | | 3) Coull | 08.1992 | 07.1995 | 24.5170-0465.3 | 331331 | BREMSSCHLAUCH | 3485043 , 3447432 | 83.6104-0462.3 |
| 460 (88-96) | 1,6 | 3) Coull | 07.1992 | 07.1996 | 24.5170-0465.3 | 331331 | BREMSSCHLAUCH | 3485043 , 3447432 | 83.6104-0462.3 |
| | 1,7 | 3) Coull | 09.1988 | 07.1996 | 24.5170-0465.3 | 331331 | BREMSSCHLAUCH | 3485043 , 3447432 | 83.6104-0462.3 |
| | | 3) Coull | 09.1990 | 07.1996 | 24.5170-0465.3 | 331331 | BREMSSCHLAUCH | 3485043 , 3447432 | 83.6104-0462.3 |
| | | 3) Coull | 08.1989 | 07.1992 | 24.5170-0465.3 | 331331 | BREMSSCHLAUCH | 3485043 , 3447432 | 83.6104-0462.3 |
| | 1,7 T | 3) Coull | 01.1991 | 07.1996 | 24.5170-0465.3 | 331331 | BREMSSCHLAUCH | 3485043 , 3447432 | 83.6104-0462.3 |
| | | 3) Coull | 08.1989 | 07.1996 | 24.5170-0465.3 | 331331 | BREMSSCHLAUCH | 3485043 , 3447432 | 83.6104-0462.3 |
| | 1,8 | 3) Coull | 08.1991 | 07.1996 | 24.5170-0465.3 | 331331 | BREMSSCHLAUCH | 3485043 , 3447432 | 83.6104-0462.3 |
| | 1,9 TD | 3) Coull | 07.1994 | 07.1996 | 24.5170-0465.3 | 331331 | BREMSSCHLAUCH | 3485043 , 3447432 | 83.6104-0462.3 |
| | 2 | 3) Coull | 08.1992 | 07.1995 | 24.5170-0465.3 | 331331 | BREMSSCHLAUCH | 3485043 , 3447432 | 83.6104-0462.3 |
| | | 3) Coull | 08.1993 | 07.1996 | 24.5170-0465.3 | 331331 | BREMSSCHLAUCH | 3485043 , 3447432 | 83.6104-0462.3 |
| 480 (86-96) | 1,7 | 3) Coull | 08.1986 | 07.1988 | 24.5170-0465.3 | 331331 | BREMSSCHLAUCH | 3485043 , 3447432 | 83.6104-0462.3 |



Bezeichnung

OE-Nummern
zu ATE
Artikelnummern



z.B. Vorsachnummern /
diverse

VOLVO

| 480 (86-96) | 1,7 | 3) Coupl | 08.1987 | 07.1989 | 24.5170-0465.3 | 331331 | BREMSSCHLAUCH | 3485043 , 3447432 | 83.6104-0462.3 |
|-------------------|------------------|----------|---------|---------|----------------|--------|-----------------|--|----------------|
| | | 3) Coupl | 09.1986 | 07.1989 | 24.5170-0465.3 | 331331 | BREMSSCHLAUCH | 3485043 , 3447432 | 83.6104-0462.3 |
| | | 3) Coupl | 08.1989 | 07.1996 | 24.5170-0465.3 | 331331 | BREMSSCHLAUCH | 3485043 , 3447432 | 83.6104-0462.3 |
| | 1,7 T | 3) Coupl | 01.1991 | 07.1996 | 24.5170-0465.3 | 331331 | BREMSSCHLAUCH | 3485043 , 3447432 | 83.6104-0462.3 |
| | | 3) Coupl | 08.1986 | 07.1996 | 24.5170-0465.3 | 331331 | BREMSSCHLAUCH | 3485043 , 3447432 | 83.6104-0462.3 |
| | 2 | 3) Coupl | 08.1992 | 09.1995 | 24.5170-0465.3 | 331331 | BREMSSCHLAUCH | 3485043 , 3447432 | 83.6104-0462.3 |
| C30 Coupe (06-12) | 1,6 | 3) Coupl | 09.2006 | 12.2012 | 03.0655-0007.2 | 370007 | DISTANCE SENSOR | 9G433311077 , 6804 6475AA , 9M68-2M113-AA , C2C 39935 , 163 540 12 17 , 30665607 | |
| | 1,6 D | 3) Coupl | 09.2006 | 12.2012 | 03.0655-0007.2 | 370007 | DISTANCE SENSOR | 9G433311077 , 6804 6475AA , 9M68-2M113-AA , C2C 39935 , 163 540 12 17 , 30665607 | |
| | 1,6 D Efficiency | 3) Coupl | 09.2008 | 12.2012 | 03.0655-0007.2 | 370007 | DISTANCE SENSOR | 9G433311077 , 6804 6475AA , 9M68-2M113-AA , C2C 39935 , 163 540 12 17 , 30665607 | |
| | 1,8 | 3) Coupl | 09.2006 | 12.2012 | 03.0655-0007.2 | 370007 | DISTANCE SENSOR | 9G433311077 , 6804 6475AA , 9M68-2M113-AA , C2C 39935 , 163 540 12 17 , 30665607 | |
| | 1,8 FlexiFuel | 3) Coupl | 04.2007 | 12.2012 | 03.0655-0007.2 | 370007 | DISTANCE SENSOR | 9G433311077 , 6804 6475AA , 9M68-2M113-AA , C2C 39935 , 163 540 12 17 , 30665607 | |
| | 2 | 3) Coupl | 09.2006 | 12.2012 | 03.0655-0007.2 | 370007 | DISTANCE SENSOR | 9G433311077 , 6804 6475AA , 9M68-2M113-AA , C2C 39935 , 163 540 12 17 , 30665607 | |



Bezeichnung

OE-Nummern
zu ATE
Artikelnummern



z.B. Vorsachnummern /
diverse

VOLVO

| Model | Engine | Body | Start | End | ATE Part No. | ATE Part No. | Description | OE Numbers | Notes |
|-----------------------|----------|---------|---------|---------|----------------|--------------|-----------------|--|-------|
| C30 Coupe (06-12) | 2,0 D | 3) Coup | 09.2006 | 12.2012 | 03.0655-0007.2 | 370007 | DISTANCE SENSOR | 9G433311077 , 6804 6475AA , 9M68-2M113-AA , C2C 39935 , 163 540 12 17 , 30665607 | |
| | 2,4 D5 | 3) Coup | 10.2006 | 12.2012 | 03.0655-0007.2 | 370007 | DISTANCE SENSOR | 9G433311077 , 6804 6475AA , 9M68-2M113-AA , C2C 39935 , 163 540 12 17 , 30665607 | |
| | | 3) Coup | 09.2006 | 12.2012 | 03.0655-0007.2 | 370007 | DISTANCE SENSOR | 9G433311077 , 6804 6475AA , 9M68-2M113-AA , C2C 39935 , 163 540 12 17 , 30665607 | |
| | 2,4 i | 3) Coup | 09.2006 | 12.2012 | 03.0655-0007.2 | 370007 | DISTANCE SENSOR | 9G433311077 , 6804 6475AA , 9M68-2M113-AA , C2C 39935 , 163 540 12 17 , 30665607 | |
| | 2,5 T5 | 3) Coup | 03.2007 | 12.2012 | 03.0655-0007.2 | 370007 | DISTANCE SENSOR | 9G433311077 , 6804 6475AA , 9M68-2M113-AA , C2C 39935 , 163 540 12 17 , 30665607 | |
| | | 3) Coup | 09.2006 | 12.2012 | 03.0655-0007.2 | 370007 | DISTANCE SENSOR | 9G433311077 , 6804 6475AA , 9M68-2M113-AA , C2C 39935 , 163 540 12 17 , 30665607 | |
| | Electric | 3) Coup | 12.2010 | 12.2012 | 03.0655-0007.2 | 370007 | DISTANCE SENSOR | 9G433311077 , 6804 6475AA , 9M68-2M113-AA , C2C 39935 , 163 540 12 17 , 30665607 | |
| C70 II Cabrio (06-13) | 2,0 D | 3) Coup | | 07.2013 | 03.0655-0007.2 | 370007 | DISTANCE SENSOR | 9G433311077 , 6804 6475AA , 9M68-2M113-AA , C2C 39935 , 163 540 12 17 , 30665607 | |
| | | 3) Coup | 06.2008 | 07.2013 | 03.0655-0007.2 | 370007 | DISTANCE SENSOR | 9G433311077 , 6804 6475AA , 9M68-2M113-AA , C2C 39935 , 163 540 12 17 , 30665607 | |



Bezeichnung

OE-Nummern
zu ATE
Artikelnummern



z.B. Vorsachnummern /
diverse

VOLVO

| C70 II Cabrio (06-13) | 2,0 D | 3) Coull | 06.2008 | | 03.0655-0007.2 | 370007 | DISTANCE SENSOR | 9G433311077 , 6804 6475AA , 9M68-2M113-AA , C2C 39935 , 163 540 12 17 , 30665607 | |
|-----------------------|--------|----------|---------|---------|----------------|--------|-----------------|--|--|
| | 2,4 | 3) Coull | 03.2006 | 07.2013 | 03.0655-0007.2 | 370007 | DISTANCE SENSOR | 9G433311077 , 6804 6475AA , 9M68-2M113-AA , C2C 39935 , 163 540 12 17 , 30665607 | |
| | 2,4 D5 | 3) Coull | 03.2006 | 07.2013 | 03.0655-0007.2 | 370007 | DISTANCE SENSOR | 9G433311077 , 6804 6475AA , 9M68-2M113-AA , C2C 39935 , 163 540 12 17 , 30665607 | |
| | 2,4 i | 3) Coull | 03.2006 | 07.2013 | 03.0655-0007.2 | 370007 | DISTANCE SENSOR | 9G433311077 , 6804 6475AA , 9M68-2M113-AA , C2C 39935 , 163 540 12 17 , 30665607 | |
| | 2,5 T5 | 3) Coull | 03.2006 | 07.2013 | 03.0655-0007.2 | 370007 | DISTANCE SENSOR | 9G433311077 , 6804 6475AA , 9M68-2M113-AA , C2C 39935 , 163 540 12 17 , 30665607 | |
| | | 3) Coull | 03.2007 | 07.2013 | 03.0655-0007.2 | 370007 | DISTANCE SENSOR | 9G433311077 , 6804 6475AA , 9M68-2M113-AA , C2C 39935 , 163 540 12 17 , 30665607 | |
| S40 II (04-12) | 1,6 D | 3) Coull | 04.2007 | 05.2012 | 03.0655-0007.2 | 370007 | DISTANCE SENSOR | 9G433311077 , 6804 6475AA , 9M68-2M113-AA , C2C 39935 , 163 540 12 17 , 30665607 | |
| | | 3) Coull | 01.2005 | 05.2012 | 03.0655-0007.2 | 370007 | DISTANCE SENSOR | 9G433311077 , 6804 6475AA , 9M68-2M113-AA , C2C 39935 , 163 540 12 17 , 30665607 | |
| | 1,6 i | 3) Coull | 01.2005 | 05.2012 | 03.0655-0007.2 | 370007 | DISTANCE SENSOR | 9G433311077 , 6804 6475AA , 9M68-2M113-AA , C2C 39935 , 163 540 12 17 , 30665607 | |



| | | | | | | | |
|--|--|--|--|--|--------------------|---|--------------------------------------|
| | | | | | Bezeichnung | OE-Nummern zu ATE Artikelnummern | z.B. Vorsachnummern / diverse |
|--|--|--|--|--|--------------------|---|--------------------------------------|

VOLVO

| | | | | | | | | |
|----------------|---------------|----------|---------|---------|----------------|--------|-----------------|--|
| S40 II (04-12) | 1,8 | 3) Coull | 04.2004 | 05.2012 | 03.0655-0007.2 | 370007 | DISTANCE SENSOR | 9G433311077 , 6804 6475AA , 9M68-2M113-AA , C2C 39935 , 163 540 12 17 , 30665607 |
| | 1,8 FlexiFuel | 3) Coull | 04.2007 | 05.2012 | 03.0655-0007.2 | 370007 | DISTANCE SENSOR | 9G433311077 , 6804 6475AA , 9M68-2M113-AA , C2C 39935 , 163 540 12 17 , 30665607 |
| | 2,0 D | 3) Coull | 01.2004 | 05.2012 | 03.0655-0007.2 | 370007 | DISTANCE SENSOR | 9G433311077 , 6804 6475AA , 9M68-2M113-AA , C2C 39935 , 163 540 12 17 , 30665607 |
| | 2,0 D4 | 3) Coull | 07.2005 | 05.2012 | 03.0655-0007.2 | 370007 | DISTANCE SENSOR | 9G433311077 , 6804 6475AA , 9M68-2M113-AA , C2C 39935 , 163 540 12 17 , 30665607 |
| | 2,0 FlexiFuel | 3) Coull | 10.2006 | 05.2012 | 03.0655-0007.2 | 370007 | DISTANCE SENSOR | 9G433311077 , 6804 6475AA , 9M68-2M113-AA , C2C 39935 , 163 540 12 17 , 30665607 |
| | 2,0 i | 3) Coull | 10.2006 | 05.2012 | 03.0655-0007.2 | 370007 | DISTANCE SENSOR | 9G433311077 , 6804 6475AA , 9M68-2M113-AA , C2C 39935 , 163 540 12 17 , 30665607 |
| | 2,4 | 3) Coull | 01.2004 | 05.2012 | 03.0655-0007.2 | 370007 | DISTANCE SENSOR | 9G433311077 , 6804 6475AA , 9M68-2M113-AA , C2C 39935 , 163 540 12 17 , 30665607 |
| | 2,4 4X4 | 3) Coull | 08.2006 | 05.2012 | 03.0655-0007.2 | 370007 | DISTANCE SENSOR | 9G433311077 , 6804 6475AA , 9M68-2M113-AA , C2C 39935 , 163 540 12 17 , 30665607 |
| | 2,4 D5 | 3) Coull | 03.2006 | 05.2012 | 03.0655-0007.2 | 370007 | DISTANCE SENSOR | 9G433311077 , 6804 6475AA , 9M68-2M113-AA , C2C 39935 , 163 540 12 17 , 30665607 |



| | | | | | | | |
|--|----------|--|--|--|--------------------|---|--|
| | i | | | | Bezeichnung | OE-Nummern zu ATE Artikelnummern | i z.B. Vorsachnummern / diverse |
|--|----------|--|--|--|--------------------|---|--|

VOLVO

| | | | | | | | | | |
|----------------|-------------|----------|---------|---------|----------------|--------|-----------------|--|--|
| S40 II (04-12) | 2,5 T5 | 3) Coull | 01.2004 | 05.2012 | 03.0655-0007.2 | 370007 | DISTANCE SENSOR | 9G433311077 , 6804 6475AA , 9M68-2M113-AA , C2C 39935 , 163 540 12 17 , 30665607 | |
| | | 3) Coull | 03.2007 | 05.2012 | 03.0655-0007.2 | 370007 | DISTANCE SENSOR | 9G433311077 , 6804 6475AA , 9M68-2M113-AA , C2C 39935 , 163 540 12 17 , 30665607 | |
| | 2,5 T5 AWD | 3) Coull | 03.2007 | 05.2012 | 03.0655-0007.2 | 370007 | DISTANCE SENSOR | 9G433311077 , 6804 6475AA , 9M68-2M113-AA , C2C 39935 , 163 540 12 17 , 30665607 | |
| | | 3) Coull | 04.2004 | 05.2012 | 03.0655-0007.2 | 370007 | DISTANCE SENSOR | 9G433311077 , 6804 6475AA , 9M68-2M113-AA , C2C 39935 , 163 540 12 17 , 30665607 | |
| S60 II (10-) | 1,6 D DRIVe | 3) Coull | 01.2011 | | 03.0655-0007.2 | 370007 | DISTANCE SENSOR | 9G433311077 , 6804 6475AA , 9M68-2M113-AA , C2C 39935 , 163 540 12 17 , 30665607 | |
| | 2,0 T | 3) Coull | 04.2010 | | 03.0655-0007.2 | 370007 | DISTANCE SENSOR | 9G433311077 , 6804 6475AA , 9M68-2M113-AA , C2C 39935 , 163 540 12 17 , 30665607 | |
| | D2 | 3) Coull | 04.2013 | | 03.0655-0007.2 | 370007 | DISTANCE SENSOR | 9G433311077 , 6804 6475AA , 9M68-2M113-AA , C2C 39935 , 163 540 12 17 , 30665607 | |
| | D3 | 3) Coull | 04.2010 | | 03.0655-0007.2 | 370007 | DISTANCE SENSOR | 9G433311077 , 6804 6475AA , 9M68-2M113-AA , C2C 39935 , 163 540 12 17 , 30665607 | |
| | D4 | 3) Coull | 09.2013 | | 03.0655-0007.2 | 370007 | DISTANCE SENSOR | 9G433311077 , 6804 6475AA , 9M68-2M113-AA , C2C 39935 , 163 540 12 17 , 30665607 | |



| | | | | | | | |
|--|----------|--|--|--|--------------------|---|--|
| | i | | | | Bezeichnung | OE-Nummern zu ATE Artikelnummern | i z.B. Vorsachnummern / diverse |
|--|----------|--|--|--|--------------------|---|--|

VOLVO

| | | | | | | | | | |
|--------------|--------|----------|---------|--|----------------|--------|-----------------|--|--|
| S60 II (10-) | D4 | 3) Coull | 05.2012 | | 03.0655-0007.2 | 370007 | DISTANCE SENSOR | 9G433311077 , 6804 6475AA , 9M68-2M113-AA , C2C 39935 , 163 540 12 17 , 30665607 | |
| | D5 | 3) Coull | 04.2010 | | 03.0655-0007.2 | 370007 | DISTANCE SENSOR | 9G433311077 , 6804 6475AA , 9M68-2M113-AA , C2C 39935 , 163 540 12 17 , 30665607 | |
| | | 3) Coull | 06.2011 | | 03.0655-0007.2 | 370007 | DISTANCE SENSOR | 9G433311077 , 6804 6475AA , 9M68-2M113-AA , C2C 39935 , 163 540 12 17 , 30665607 | |
| | D5 AWD | 3) Coull | 04.2010 | | 03.0655-0007.2 | 370007 | DISTANCE SENSOR | 9G433311077 , 6804 6475AA , 9M68-2M113-AA , C2C 39935 , 163 540 12 17 , 30665607 | |
| | | 3) Coull | 06.2011 | | 03.0655-0007.2 | 370007 | DISTANCE SENSOR | 9G433311077 , 6804 6475AA , 9M68-2M113-AA , C2C 39935 , 163 540 12 17 , 30665607 | |
| | T3 | 3) Coull | 04.2010 | | 03.0655-0007.2 | 370007 | DISTANCE SENSOR | 9G433311077 , 6804 6475AA , 9M68-2M113-AA , C2C 39935 , 163 540 12 17 , 30665607 | |
| | T4 | 3) Coull | 04.2010 | | 03.0655-0007.2 | 370007 | DISTANCE SENSOR | 9G433311077 , 6804 6475AA , 9M68-2M113-AA , C2C 39935 , 163 540 12 17 , 30665607 | |
| | T4F | 3) Coull | 04.2011 | | 03.0655-0007.2 | 370007 | DISTANCE SENSOR | 9G433311077 , 6804 6475AA , 9M68-2M113-AA , C2C 39935 , 163 540 12 17 , 30665607 | |
| | T5 | 3) Coull | 09.2013 | | 03.0655-0007.2 | 370007 | DISTANCE SENSOR | 9G433311077 , 6804 6475AA , 9M68-2M113-AA , C2C 39935 , 163 540 12 17 , 30665607 | |



| | | | | | | | |
|--|--|--|--|--|--------------------|---|--------------------------------------|
| | | | | | Bezeichnung | OE-Nummern zu ATE Artikelnummern | z.B. Vorsachnummern / diverse |
|--|--|--|--|--|--------------------|---|--------------------------------------|

VOLVO

| | | | | | | | | |
|--------------|---------------|----------|---------|--|----------------|--------|-----------------|--|
| S60 II (10-) | T5 | 3) Coull | 04.2010 | | 03.0655-0007.2 | 370007 | DISTANCE SENSOR | 9G433311077 , 6804 6475AA , 9M68-2M113-AA , C2C 39935 , 163 540 12 17 , 30665607 |
| | T6 | 3) Coull | 09.2013 | | 03.0655-0007.2 | 370007 | DISTANCE SENSOR | 9G433311077 , 6804 6475AA , 9M68-2M113-AA , C2C 39935 , 163 540 12 17 , 30665607 |
| | T6 AWD | 3) Coull | 04.2010 | | 03.0655-0007.2 | 370007 | DISTANCE SENSOR | 9G433311077 , 6804 6475AA , 9M68-2M113-AA , C2C 39935 , 163 540 12 17 , 30665607 |
| S80 II (06-) | 1,6 D DRIVe | 3) Coull | | | 03.0655-0007.2 | 370007 | DISTANCE SENSOR | 9G433311077 , 6804 6475AA , 9M68-2M113-AA , C2C 39935 , 163 540 12 17 , 30665607 |
| | | 3) Coull | 01.2010 | | 03.0655-0007.2 | 370007 | DISTANCE SENSOR | 9G433311077 , 6804 6475AA , 9M68-2M113-AA , C2C 39935 , 163 540 12 17 , 30665607 |
| | 2 | 3) Coull | 09.2007 | | 03.0655-0007.2 | 370007 | DISTANCE SENSOR | 9G433311077 , 6804 6475AA , 9M68-2M113-AA , C2C 39935 , 163 540 12 17 , 30665607 |
| | 2,0 D | 3) Coull | 09.2007 | | 03.0655-0007.2 | 370007 | DISTANCE SENSOR | 9G433311077 , 6804 6475AA , 9M68-2M113-AA , C2C 39935 , 163 540 12 17 , 30665607 |
| | 2,0 FlexiFuel | 3) Coull | 09.2007 | | 03.0655-0007.2 | 370007 | DISTANCE SENSOR | 9G433311077 , 6804 6475AA , 9M68-2M113-AA , C2C 39935 , 163 540 12 17 , 30665607 |
| | 2,0 T | 3) Coull | 01.2010 | | 03.0655-0007.2 | 370007 | DISTANCE SENSOR | 9G433311077 , 6804 6475AA , 9M68-2M113-AA , C2C 39935 , 163 540 12 17 , 30665607 |



| | | | | | | | |
|--|----------|--|--|--|--------------------|---|--|
| | i | | | | Bezeichnung | OE-Nummern zu ATE Artikelnummern | i z.B. Vorsachnummern / diverse |
|--|----------|--|--|--|--------------------|---|--|

VOLVO

| | | | | | | | | | |
|--------------|------------|----------|---------|--|----------------|--------|-----------------|--|--|
| S80 II (06-) | 2,0 TDi | 3) Coull | 02.2008 | | 03.0655-0007.2 | 370007 | DISTANCE SENSOR | 9G433311077 , 6804 6475AA , 9M68-2M113-AA , C2C 39935 , 163 540 12 17 , 30665607 | |
| | 2,4 D | 3) Coull | 04.2009 | | 03.0655-0007.2 | 370007 | DISTANCE SENSOR | 9G433311077 , 6804 6475AA , 9M68-2M113-AA , C2C 39935 , 163 540 12 17 , 30665607 | |
| | | 3) Coull | 03.2006 | | 03.0655-0007.2 | 370007 | DISTANCE SENSOR | 9G433311077 , 6804 6475AA , 9M68-2M113-AA , C2C 39935 , 163 540 12 17 , 30665607 | |
| | 2,4 D5 | 3) Coull | 11.2008 | | 03.0655-0007.2 | 370007 | DISTANCE SENSOR | 9G433311077 , 6804 6475AA , 9M68-2M113-AA , C2C 39935 , 163 540 12 17 , 30665607 | |
| | | 3) Coull | 03.2006 | | 03.0655-0007.2 | 370007 | DISTANCE SENSOR | 9G433311077 , 6804 6475AA , 9M68-2M113-AA , C2C 39935 , 163 540 12 17 , 30665607 | |
| | | 3) Coull | 06.2011 | | 03.0655-0007.2 | 370007 | DISTANCE SENSOR | 9G433311077 , 6804 6475AA , 9M68-2M113-AA , C2C 39935 , 163 540 12 17 , 30665607 | |
| | | 3) Coull | | | 03.0655-0007.2 | 370007 | DISTANCE SENSOR | 9G433311077 , 6804 6475AA , 9M68-2M113-AA , C2C 39935 , 163 540 12 17 , 30665607 | |
| | 2,4 D5 AWD | 3) Coull | 06.2011 | | 03.0655-0007.2 | 370007 | DISTANCE SENSOR | 9G433311077 , 6804 6475AA , 9M68-2M113-AA , C2C 39935 , 163 540 12 17 , 30665607 | |
| | | 3) Coull | 01.2007 | | 03.0655-0007.2 | 370007 | DISTANCE SENSOR | 9G433311077 , 6804 6475AA , 9M68-2M113-AA , C2C 39935 , 163 540 12 17 , 30665607 | |



| | | | | | | | |
|--|--|--|--|--|--------------------|---|--------------------------------------|
| | | | | | Bezeichnung | OE-Nummern zu ATE Artikelnummern | z.B. Vorsachnummern / diverse |
|--|--|--|--|--|--------------------|---|--------------------------------------|

VOLVO

| | | | | | | | | |
|--------------|-----------------|----------|---------|--|----------------|--------|-----------------|--|
| S80 II (06-) | 2,4 D5 AWD | 3) Coull | | | 03.0655-0007.2 | 370007 | DISTANCE SENSOR | 9G433311077 , 6804 6475AA , 9M68-2M113-AA , C2C 39935 , 163 540 12 17 , 30665607 |
| | | 3) Coull | 01.2010 | | 03.0655-0007.2 | 370007 | DISTANCE SENSOR | 9G433311077 , 6804 6475AA , 9M68-2M113-AA , C2C 39935 , 163 540 12 17 , 30665607 |
| | 2,5 T | 3) Coull | | | 03.0655-0007.2 | 370007 | DISTANCE SENSOR | 9G433311077 , 6804 6475AA , 9M68-2M113-AA , C2C 39935 , 163 540 12 17 , 30665607 |
| | | 3) Coull | 01.2010 | | 03.0655-0007.2 | 370007 | DISTANCE SENSOR | 9G433311077 , 6804 6475AA , 9M68-2M113-AA , C2C 39935 , 163 540 12 17 , 30665607 |
| | | 3) Coull | 03.2006 | | 03.0655-0007.2 | 370007 | DISTANCE SENSOR | 9G433311077 , 6804 6475AA , 9M68-2M113-AA , C2C 39935 , 163 540 12 17 , 30665607 |
| | 2,5 T AWD | 3) Coull | 10.2006 | | 03.0655-0007.2 | 370007 | DISTANCE SENSOR | 9G433311077 , 6804 6475AA , 9M68-2M113-AA , C2C 39935 , 163 540 12 17 , 30665607 |
| | 2,5 T FlexFuel | 3) Coull | 04.2008 | | 03.0655-0007.2 | 370007 | DISTANCE SENSOR | 9G433311077 , 6804 6475AA , 9M68-2M113-AA , C2C 39935 , 163 540 12 17 , 30665607 |
| | 2,5 T FlexiFuel | 3) Coull | | | 03.0655-0007.2 | 370007 | DISTANCE SENSOR | 9G433311077 , 6804 6475AA , 9M68-2M113-AA , C2C 39935 , 163 540 12 17 , 30665607 |
| | | 3) Coull | 01.2010 | | 03.0655-0007.2 | 370007 | DISTANCE SENSOR | 9G433311077 , 6804 6475AA , 9M68-2M113-AA , C2C 39935 , 163 540 12 17 , 30665607 |



| | | | | | | | |
|--|----------|--|--|--|--------------------|---|--|
| | i | | | | Bezeichnung | OE-Nummern zu ATE Artikelnummern | i z.B. Vorsachnummern / diverse |
|--|----------|--|--|--|--------------------|---|--|

VOLVO

| | | | | | | | | |
|--------------|------------|----------|---------|--|----------------|--------|-----------------|--|
| S80 II (06-) | 3,0 T6 AWD | 3) Coull | 01.2007 | | 03.0655-0007.2 | 370007 | DISTANCE SENSOR | 9G433311077 , 6804 6475AA , 9M68-2M113-AA , C2C 39935 , 163 540 12 17 , 30665607 |
| | 3,2 | 3) Coull | 03.2006 | | 03.0655-0007.2 | 370007 | DISTANCE SENSOR | 9G433311077 , 6804 6475AA , 9M68-2M113-AA , C2C 39935 , 163 540 12 17 , 30665607 |
| | 3,2 AWD | 3) Coull | 01.2007 | | 03.0655-0007.2 | 370007 | DISTANCE SENSOR | 9G433311077 , 6804 6475AA , 9M68-2M113-AA , C2C 39935 , 163 540 12 17 , 30665607 |
| | D2 | 3) Coull | 04.2013 | | 03.0655-0007.2 | 370007 | DISTANCE SENSOR | 9G433311077 , 6804 6475AA , 9M68-2M113-AA , C2C 39935 , 163 540 12 17 , 30665607 |
| | | 3) Coull | | | 03.0655-0007.2 | 370007 | DISTANCE SENSOR | 9G433311077 , 6804 6475AA , 9M68-2M113-AA , C2C 39935 , 163 540 12 17 , 30665607 |
| | D3 | 3) Coull | 01.2010 | | 03.0655-0007.2 | 370007 | DISTANCE SENSOR | 9G433311077 , 6804 6475AA , 9M68-2M113-AA , C2C 39935 , 163 540 12 17 , 30665607 |
| | | 3) Coull | 05.2012 | | 03.0655-0007.2 | 370007 | DISTANCE SENSOR | 9G433311077 , 6804 6475AA , 9M68-2M113-AA , C2C 39935 , 163 540 12 17 , 30665607 |
| | | 3) Coull | | | 03.0655-0007.2 | 370007 | DISTANCE SENSOR | 9G433311077 , 6804 6475AA , 9M68-2M113-AA , C2C 39935 , 163 540 12 17 , 30665607 |
| | D4 | 3) Coull | 09.2013 | | 03.0655-0007.2 | 370007 | DISTANCE SENSOR | 9G433311077 , 6804 6475AA , 9M68-2M113-AA , C2C 39935 , 163 540 12 17 , 30665607 |



| | | | | | | | |
|--|--|--|--|--|--------------------|---|--------------------------------------|
| | | | | | Bezeichnung | OE-Nummern zu ATE Artikelnummern | z.B. Vorsachnummern / diverse |
|--|--|--|--|--|--------------------|---|--------------------------------------|

VOLVO

| | | | | | | | | |
|--------------|--------|----------|---------|---------|----------------|--------|-----------------|--|
| S80 II (06-) | T4 | 3) Coull | | | 03.0655-0007.2 | 370007 | DISTANCE SENSOR | 9G433311077 , 6804 6475AA , 9M68-2M113-AA , C2C 39935 , 163 540 12 17 , 30665607 |
| | | 3) Coull | 10.2010 | | 03.0655-0007.2 | 370007 | DISTANCE SENSOR | 9G433311077 , 6804 6475AA , 9M68-2M113-AA , C2C 39935 , 163 540 12 17 , 30665607 |
| | T4F | 3) Coull | | | 03.0655-0007.2 | 370007 | DISTANCE SENSOR | 9G433311077 , 6804 6475AA , 9M68-2M113-AA , C2C 39935 , 163 540 12 17 , 30665607 |
| | | 3) Coull | 05.2011 | | 03.0655-0007.2 | 370007 | DISTANCE SENSOR | 9G433311077 , 6804 6475AA , 9M68-2M113-AA , C2C 39935 , 163 540 12 17 , 30665607 |
| | T5 | 3) Coull | 09.2013 | | 03.0655-0007.2 | 370007 | DISTANCE SENSOR | 9G433311077 , 6804 6475AA , 9M68-2M113-AA , C2C 39935 , 163 540 12 17 , 30665607 |
| | | 3) Coull | 10.2010 | | 03.0655-0007.2 | 370007 | DISTANCE SENSOR | 9G433311077 , 6804 6475AA , 9M68-2M113-AA , C2C 39935 , 163 540 12 17 , 30665607 |
| | T6 AWD | 3) Coull | | | 03.0655-0007.2 | 370007 | DISTANCE SENSOR | 9G433311077 , 6804 6475AA , 9M68-2M113-AA , C2C 39935 , 163 540 12 17 , 30665607 |
| | | 3) Coull | 10.2010 | | 03.0655-0007.2 | 370007 | DISTANCE SENSOR | 9G433311077 , 6804 6475AA , 9M68-2M113-AA , C2C 39935 , 163 540 12 17 , 30665607 |
| V50 (04-12) | 1,6 D | 3) Coull | 04.2007 | 05.2012 | 03.0655-0007.2 | 370007 | DISTANCE SENSOR | 9G433311077 , 6804 6475AA , 9M68-2M113-AA , C2C 39935 , 163 540 12 17 , 30665607 |



| | | | | | | | |
|--|--|--|--|--|--------------------|---|--------------------------------------|
| | | | | | Bezeichnung | OE-Nummern zu ATE Artikelnummern | z.B. Vorsachnummern / diverse |
|--|--|--|--|--|--------------------|---|--------------------------------------|

VOLVO

| | | | | | | | | |
|-------------|---------------|----------|---------|---------|----------------|--------|-----------------|--|
| V50 (04-12) | 1,6 D | 3) Coull | 01.2005 | 05.2012 | 03.0655-0007.2 | 370007 | DISTANCE SENSOR | 9G433311077 , 6804 6475AA , 9M68-2M113-AA , C2C 39935 , 163 540 12 17 , 30665607 |
| | 1,6 i | 3) Coull | 01.2005 | 05.2012 | 03.0655-0007.2 | 370007 | DISTANCE SENSOR | 9G433311077 , 6804 6475AA , 9M68-2M113-AA , C2C 39935 , 163 540 12 17 , 30665607 |
| | 1,8 | 3) Coull | 04.2004 | 05.2012 | 03.0655-0007.2 | 370007 | DISTANCE SENSOR | 9G433311077 , 6804 6475AA , 9M68-2M113-AA , C2C 39935 , 163 540 12 17 , 30665607 |
| | 1,8 FlexiFuel | 3) Coull | 04.2007 | 05.2012 | 03.0655-0007.2 | 370007 | DISTANCE SENSOR | 9G433311077 , 6804 6475AA , 9M68-2M113-AA , C2C 39935 , 163 540 12 17 , 30665607 |
| | 2,0 D | 3) Coull | 04.2004 | 05.2012 | 03.0655-0007.2 | 370007 | DISTANCE SENSOR | 9G433311077 , 6804 6475AA , 9M68-2M113-AA , C2C 39935 , 163 540 12 17 , 30665607 |
| | 2,0 FlexiFuel | 3) Coull | 01.2010 | 05.2012 | 03.0655-0007.2 | 370007 | DISTANCE SENSOR | 9G433311077 , 6804 6475AA , 9M68-2M113-AA , C2C 39935 , 163 540 12 17 , 30665607 |
| | 2,0 i | 3) Coull | 10.2006 | 05.2012 | 03.0655-0007.2 | 370007 | DISTANCE SENSOR | 9G433311077 , 6804 6475AA , 9M68-2M113-AA , C2C 39935 , 163 540 12 17 , 30665607 |
| | 2,4 | 3) Coull | 04.2004 | 05.2012 | 03.0655-0007.2 | 370007 | DISTANCE SENSOR | 9G433311077 , 6804 6475AA , 9M68-2M113-AA , C2C 39935 , 163 540 12 17 , 30665607 |
| | 2,4 AWD | 3) Coull | 08.2006 | 05.2012 | 03.0655-0007.2 | 370007 | DISTANCE SENSOR | 9G433311077 , 6804 6475AA , 9M68-2M113-AA , C2C 39935 , 163 540 12 17 , 30665607 |



| | | | | | | | |
|--|----------|--|--|--|--------------------|---|--|
| | i | | | | Bezeichnung | OE-Nummern zu ATE Artikelnummern | i z.B. Vorsachnummern / diverse |
|--|----------|--|--|--|--------------------|---|--|

VOLVO

| | | | | | | | | |
|-------------|------------|----------|---------|---------|----------------|--------|-----------------|--|
| V50 (04-12) | 2,4 D5 | 3) Coull | 03.2006 | 05.2012 | 03.0655-0007.2 | 370007 | DISTANCE SENSOR | 9G433311077 , 6804 6475AA , 9M68-2M113-AA , C2C 39935 , 163 540 12 17 , 30665607 |
| | 2,4 Tdi | 3) Coull | 05.2007 | 05.2012 | 03.0655-0007.2 | 370007 | DISTANCE SENSOR | 9G433311077 , 6804 6475AA , 9M68-2M113-AA , C2C 39935 , 163 540 12 17 , 30665607 |
| | 2,5 T5 | 3) Coull | 04.2004 | 05.2012 | 03.0655-0007.2 | 370007 | DISTANCE SENSOR | 9G433311077 , 6804 6475AA , 9M68-2M113-AA , C2C 39935 , 163 540 12 17 , 30665607 |
| | | 3) Coull | 03.2007 | 05.2012 | 03.0655-0007.2 | 370007 | DISTANCE SENSOR | 9G433311077 , 6804 6475AA , 9M68-2M113-AA , C2C 39935 , 163 540 12 17 , 30665607 |
| | 2,5 T5 AWD | 3) Coull | 03.2007 | 05.2012 | 03.0655-0007.2 | 370007 | DISTANCE SENSOR | 9G433311077 , 6804 6475AA , 9M68-2M113-AA , C2C 39935 , 163 540 12 17 , 30665607 |
| | | 3) Coull | 04.2004 | 05.2012 | 03.0655-0007.2 | 370007 | DISTANCE SENSOR | 9G433311077 , 6804 6475AA , 9M68-2M113-AA , C2C 39935 , 163 540 12 17 , 30665607 |
| V60 (10-) | 1,6 DRiVe | 3) Coull | 06.2011 | | 03.0655-0007.2 | 370007 | DISTANCE SENSOR | 9G433311077 , 6804 6475AA , 9M68-2M113-AA , C2C 39935 , 163 540 12 17 , 30665607 |
| | 2,0 T | 3) Coull | 11.2010 | | 03.0655-0007.2 | 370007 | DISTANCE SENSOR | 9G433311077 , 6804 6475AA , 9M68-2M113-AA , C2C 39935 , 163 540 12 17 , 30665607 |
| | 2,4 D5 | 3) Coull | 06.2011 | | 03.0655-0007.2 | 370007 | DISTANCE SENSOR | 9G433311077 , 6804 6475AA , 9M68-2M113-AA , C2C 39935 , 163 540 12 17 , 30665607 |



Bezeichnung

OE-Nummern
zu ATE
Artikelnummern



z.B. Vorsachnummern /
diverse

VOLVO

| V60 (10-) | 2,4 D5 AWD | 3) Coull | 06.2011 | | 03.0655-0007.2 | 370007 | DISTANCE SENSOR | 9G433311077 , 6804 6475AA , 9M68-2M113-AA , C2C 39935 , 163 540 12 17 , 30665607 | |
|-----------|-----------------------|----------|---------|--|----------------|--------|-----------------|--|--|
| | 2,4 D6 Plug-in-Hybrid | 3) Coull | 11.2012 | | 03.0655-0007.2 | 370007 | DISTANCE SENSOR | 9G433311077 , 6804 6475AA , 9M68-2M113-AA , C2C 39935 , 163 540 12 17 , 30665607 | |
| | D 3 | 3) Coull | 11.2010 | | 03.0655-0007.2 | 370007 | DISTANCE SENSOR | 9G433311077 , 6804 6475AA , 9M68-2M113-AA , C2C 39935 , 163 540 12 17 , 30665607 | |
| | | 3) Coull | 10.2012 | | 03.0655-0007.2 | 370007 | DISTANCE SENSOR | 9G433311077 , 6804 6475AA , 9M68-2M113-AA , C2C 39935 , 163 540 12 17 , 30665607 | |
| | D 5 | 3) Coull | 11.2010 | | 03.0655-0007.2 | 370007 | DISTANCE SENSOR | 9G433311077 , 6804 6475AA , 9M68-2M113-AA , C2C 39935 , 163 540 12 17 , 30665607 | |
| | D 5 AWD | 3) Coull | 11.2010 | | 03.0655-0007.2 | 370007 | DISTANCE SENSOR | 9G433311077 , 6804 6475AA , 9M68-2M113-AA , C2C 39935 , 163 540 12 17 , 30665607 | |
| | D4 | 3) Coull | 10.2013 | | 03.0655-0007.2 | 370007 | DISTANCE SENSOR | 9G433311077 , 6804 6475AA , 9M68-2M113-AA , C2C 39935 , 163 540 12 17 , 30665607 | |
| | D4 AWD | 3) Coull | 10.2013 | | 03.0655-0007.2 | 370007 | DISTANCE SENSOR | 9G433311077 , 6804 6475AA , 9M68-2M113-AA , C2C 39935 , 163 540 12 17 , 30665607 | |
| | T 6 AWD | 3) Coull | 11.2010 | | 03.0655-0007.2 | 370007 | DISTANCE SENSOR | 9G433311077 , 6804 6475AA , 9M68-2M113-AA , C2C 39935 , 163 540 12 17 , 30665607 | |



Bezeichnung

OE-Nummern
zu ATE
Artikelnummern



z.B. Vorsachnummern /
diverse

VOLVO

| | | | | | | | | | |
|---------------|-----------|----------|---------|--|----------------|--------|-----------------|--|--|
| V60 (10-) | T3 | 3) Coull | 11.2010 | | 03.0655-0007.2 | 370007 | DISTANCE SENSOR | 9G433311077 , 6804 6475AA , 9M68-2M113-AA , C2C 39935 , 163 540 12 17 , 30665607 | |
| | T4 | 3) Coull | 11.2010 | | 03.0655-0007.2 | 370007 | DISTANCE SENSOR | 9G433311077 , 6804 6475AA , 9M68-2M113-AA , C2C 39935 , 163 540 12 17 , 30665607 | |
| | T4F | 3) Coull | 04.2011 | | 03.0655-0007.2 | 370007 | DISTANCE SENSOR | 9G433311077 , 6804 6475AA , 9M68-2M113-AA , C2C 39935 , 163 540 12 17 , 30665607 | |
| | T5 | 3) Coull | 10.2013 | | 03.0655-0007.2 | 370007 | DISTANCE SENSOR | 9G433311077 , 6804 6475AA , 9M68-2M113-AA , C2C 39935 , 163 540 12 17 , 30665607 | |
| | | 3) Coull | 11.2010 | | 03.0655-0007.2 | 370007 | DISTANCE SENSOR | 9G433311077 , 6804 6475AA , 9M68-2M113-AA , C2C 39935 , 163 540 12 17 , 30665607 | |
| | T6 | 3) Coull | 10.2013 | | 03.0655-0007.2 | 370007 | DISTANCE SENSOR | 9G433311077 , 6804 6475AA , 9M68-2M113-AA , C2C 39935 , 163 540 12 17 , 30665607 | |
| V70 III (07-) | 1,6 DRiVe | 3) Coull | 01.2010 | | 03.0655-0007.2 | 370007 | DISTANCE SENSOR | 9G433311077 , 6804 6475AA , 9M68-2M113-AA , C2C 39935 , 163 540 12 17 , 30665607 | |
| | 1,6 T4F | 3) Coull | | | 03.0655-0007.2 | 370007 | DISTANCE SENSOR | 9G433311077 , 6804 6475AA , 9M68-2M113-AA , C2C 39935 , 163 540 12 17 , 30665607 | |
| | | 3) Coull | 01.2011 | | 03.0655-0007.2 | 370007 | DISTANCE SENSOR | 9G433311077 , 6804 6475AA , 9M68-2M113-AA , C2C 39935 , 163 540 12 17 , 30665607 | |



| | | | | | | | |
|--|--|--|--|--|--------------------|---|--------------------------------------|
| | | | | | Bezeichnung | OE-Nummern zu ATE Artikelnummern | z.B. Vorsachnummern / diverse |
|--|--|--|--|--|--------------------|---|--------------------------------------|

VOLVO

| | | | | | | | | | |
|---------------|---------------|----------|---------|--|----------------|--------|-----------------|--|--|
| V70 III (07-) | 2 | 3) Coull | 10.2007 | | 03.0655-0007.2 | 370007 | DISTANCE SENSOR | 9G433311077 , 6804 6475AA , 9M68-2M113-AA , C2C 39935 , 163 540 12 17 , 30665607 | |
| | 2,0 D | 3) Coull | 10.2007 | | 03.0655-0007.2 | 370007 | DISTANCE SENSOR | 9G433311077 , 6804 6475AA , 9M68-2M113-AA , C2C 39935 , 163 540 12 17 , 30665607 | |
| | 2,0 D3 | 3) Coull | 03.2010 | | 03.0655-0007.2 | 370007 | DISTANCE SENSOR | 9G433311077 , 6804 6475AA , 9M68-2M113-AA , C2C 39935 , 163 540 12 17 , 30665607 | |
| | | 3) Coull | 05.2012 | | 03.0655-0007.2 | 370007 | DISTANCE SENSOR | 9G433311077 , 6804 6475AA , 9M68-2M113-AA , C2C 39935 , 163 540 12 17 , 30665607 | |
| | | 3) Coull | | | 03.0655-0007.2 | 370007 | DISTANCE SENSOR | 9G433311077 , 6804 6475AA , 9M68-2M113-AA , C2C 39935 , 163 540 12 17 , 30665607 | |
| | 2,0 D4 | 3) Coull | 01.2013 | | 03.0655-0007.2 | 370007 | DISTANCE SENSOR | 9G433311077 , 6804 6475AA , 9M68-2M113-AA , C2C 39935 , 163 540 12 17 , 30665607 | |
| | 2,0 FlexiFuel | 3) Coull | 09.2007 | | 03.0655-0007.2 | 370007 | DISTANCE SENSOR | 9G433311077 , 6804 6475AA , 9M68-2M113-AA , C2C 39935 , 163 540 12 17 , 30665607 | |
| | 2,0 T | 3) Coull | 01.2010 | | 03.0655-0007.2 | 370007 | DISTANCE SENSOR | 9G433311077 , 6804 6475AA , 9M68-2M113-AA , C2C 39935 , 163 540 12 17 , 30665607 | |
| | 2,4 D | 3) Coull | | | 03.0655-0007.2 | 370007 | DISTANCE SENSOR | 9G433311077 , 6804 6475AA , 9M68-2M113-AA , C2C 39935 , 163 540 12 17 , 30665607 | |



| | | | | | | | |
|--|----------|--|--|--|--------------------|---|--|
| | i | | | | Bezeichnung | OE-Nummern zu ATE Artikelnummern | i z.B. Vorsachnummern / diverse |
|--|----------|--|--|--|--------------------|---|--|

VOLVO

| | | | | | | | | | |
|---------------|------------|----------|---------|--|----------------|--------|-----------------|--|--|
| V70 III (07-) | 2,4 D | 3) Coull | 08.2007 | | 03.0655-0007.2 | 370007 | DISTANCE SENSOR | 9G433311077 , 6804 6475AA , 9M68-2M113-AA , C2C 39935 , 163 540 12 17 , 30665607 | |
| | | 3) Coull | 10.2009 | | 03.0655-0007.2 | 370007 | DISTANCE SENSOR | 9G433311077 , 6804 6475AA , 9M68-2M113-AA , C2C 39935 , 163 540 12 17 , 30665607 | |
| | 2,4 D4 AWD | 3) Coull | 01.2013 | | 03.0655-0007.2 | 370007 | DISTANCE SENSOR | 9G433311077 , 6804 6475AA , 9M68-2M113-AA , C2C 39935 , 163 540 12 17 , 30665607 | |
| | 2,4 D5 | 3) Coull | 12.2009 | | 03.0655-0007.2 | 370007 | DISTANCE SENSOR | 9G433311077 , 6804 6475AA , 9M68-2M113-AA , C2C 39935 , 163 540 12 17 , 30665607 | |
| | | 3) Coull | | | 03.0655-0007.2 | 370007 | DISTANCE SENSOR | 9G433311077 , 6804 6475AA , 9M68-2M113-AA , C2C 39935 , 163 540 12 17 , 30665607 | |
| | | 3) Coull | 06.2011 | | 03.0655-0007.2 | 370007 | DISTANCE SENSOR | 9G433311077 , 6804 6475AA , 9M68-2M113-AA , C2C 39935 , 163 540 12 17 , 30665607 | |
| | | 3) Coull | 08.2007 | | 03.0655-0007.2 | 370007 | DISTANCE SENSOR | 9G433311077 , 6804 6475AA , 9M68-2M113-AA , C2C 39935 , 163 540 12 17 , 30665607 | |
| | 2,4 D5 AWD | 3) Coull | 10.2007 | | 03.0655-0007.2 | 370007 | DISTANCE SENSOR | 9G433311077 , 6804 6475AA , 9M68-2M113-AA , C2C 39935 , 163 540 12 17 , 30665607 | |
| | | 3) Coull | 12.2009 | | 03.0655-0007.2 | 370007 | DISTANCE SENSOR | 9G433311077 , 6804 6475AA , 9M68-2M113-AA , C2C 39935 , 163 540 12 17 , 30665607 | |



| | | | | | | | |
|--|----------|--|--|--|--------------------|---|--|
| | i | | | | Bezeichnung | OE-Nummern zu ATE Artikelnummern | i z.B. Vorsachnummern / diverse |
|--|----------|--|--|--|--------------------|---|--|

VOLVO

| | | | | | | | | |
|---------------|-----------------|----------|---------|--|----------------|--------|-----------------|--|
| V70 III (07-) | 2,4 D5 AWD | 3) Coull | | | 03.0655-0007.2 | 370007 | DISTANCE SENSOR | 9G433311077 , 6804 6475AA , 9M68-2M113-AA , C2C 39935 , 163 540 12 17 , 30665607 |
| | | 3) Coull | 06.2011 | | 03.0655-0007.2 | 370007 | DISTANCE SENSOR | 9G433311077 , 6804 6475AA , 9M68-2M113-AA , C2C 39935 , 163 540 12 17 , 30665607 |
| | 2,5 T | 3) Coull | 08.2007 | | 03.0655-0007.2 | 370007 | DISTANCE SENSOR | 9G433311077 , 6804 6475AA , 9M68-2M113-AA , C2C 39935 , 163 540 12 17 , 30665607 |
| | | 3) Coull | 10.2009 | | 03.0655-0007.2 | 370007 | DISTANCE SENSOR | 9G433311077 , 6804 6475AA , 9M68-2M113-AA , C2C 39935 , 163 540 12 17 , 30665607 |
| | | 3) Coull | | | 03.0655-0007.2 | 370007 | DISTANCE SENSOR | 9G433311077 , 6804 6475AA , 9M68-2M113-AA , C2C 39935 , 163 540 12 17 , 30665607 |
| | 2,5 T FlexiFuel | 3) Coull | | | 03.0655-0007.2 | 370007 | DISTANCE SENSOR | 9G433311077 , 6804 6475AA , 9M68-2M113-AA , C2C 39935 , 163 540 12 17 , 30665607 |
| | | 3) Coull | 04.2008 | | 03.0655-0007.2 | 370007 | DISTANCE SENSOR | 9G433311077 , 6804 6475AA , 9M68-2M113-AA , C2C 39935 , 163 540 12 17 , 30665607 |
| | | 3) Coull | 10.2009 | | 03.0655-0007.2 | 370007 | DISTANCE SENSOR | 9G433311077 , 6804 6475AA , 9M68-2M113-AA , C2C 39935 , 163 540 12 17 , 30665607 |
| | 3,0 T6 AWD | 3) Coull | | | 03.0655-0007.2 | 370007 | DISTANCE SENSOR | 9G433311077 , 6804 6475AA , 9M68-2M113-AA , C2C 39935 , 163 540 12 17 , 30665607 |



| | | | | | | | |
|--|----------|--|--|--|--------------------|---|--|
| | i | | | | Bezeichnung | OE-Nummern zu ATE Artikelnummern | i z.B. Vorsachnummern / diverse |
|--|----------|--|--|--|--------------------|---|--|

VOLVO

| | | | | | | | | | |
|---------------|------------|----------|---------|--|----------------|--------|-----------------|--|--|
| V70 III (07-) | 3,0 T6 AWD | 3) Coull | 04.2011 | | 03.0655-0007.2 | 370007 | DISTANCE SENSOR | 9G433311077 , 6804 6475AA , 9M68-2M113-AA , C2C 39935 , 163 540 12 17 , 30665607 | |
| | | 3) Coull | 08.2007 | | 03.0655-0007.2 | 370007 | DISTANCE SENSOR | 9G433311077 , 6804 6475AA , 9M68-2M113-AA , C2C 39935 , 163 540 12 17 , 30665607 | |
| | 3,2 | 3) Coull | | | 03.0655-0007.2 | 370007 | DISTANCE SENSOR | 9G433311077 , 6804 6475AA , 9M68-2M113-AA , C2C 39935 , 163 540 12 17 , 30665607 | |
| | | 3) Coull | 08.2007 | | 03.0655-0007.2 | 370007 | DISTANCE SENSOR | 9G433311077 , 6804 6475AA , 9M68-2M113-AA , C2C 39935 , 163 540 12 17 , 30665607 | |
| | 3,2 AWD | 3) Coull | | | 03.0655-0007.2 | 370007 | DISTANCE SENSOR | 9G433311077 , 6804 6475AA , 9M68-2M113-AA , C2C 39935 , 163 540 12 17 , 30665607 | |
| | | 3) Coull | 08.2007 | | 03.0655-0007.2 | 370007 | DISTANCE SENSOR | 9G433311077 , 6804 6475AA , 9M68-2M113-AA , C2C 39935 , 163 540 12 17 , 30665607 | |
| | D4 | 3) Coull | 10.2013 | | 03.0655-0007.2 | 370007 | DISTANCE SENSOR | 9G433311077 , 6804 6475AA , 9M68-2M113-AA , C2C 39935 , 163 540 12 17 , 30665607 | |
| | D4 AWD | 3) Coull | 10.2013 | | 03.0655-0007.2 | 370007 | DISTANCE SENSOR | 9G433311077 , 6804 6475AA , 9M68-2M113-AA , C2C 39935 , 163 540 12 17 , 30665607 | |
| | T4 | 3) Coull | | | 03.0655-0007.2 | 370007 | DISTANCE SENSOR | 9G433311077 , 6804 6475AA , 9M68-2M113-AA , C2C 39935 , 163 540 12 17 , 30665607 | |



| | | | | | | | |
|--|----------|--|--|--|--------------------|---|--|
| | i | | | | Bezeichnung | OE-Nummern zu ATE Artikelnummern | i z.B. Vorsachnummern / diverse |
|--|----------|--|--|--|--------------------|---|--|

VOLVO

| | | | | | | | | | |
|---------------|--------------|----------|---------|--|----------------|--------|-----------------|--|--|
| V70 III (07-) | T4 | 3) Coull | 10.2010 | | 03.0655-0007.2 | 370007 | DISTANCE SENSOR | 9G433311077 , 6804 6475AA , 9M68-2M113-AA , C2C 39935 , 163 540 12 17 , 30665607 | |
| | T5 | 3) Coull | 01.2010 | | 03.0655-0007.2 | 370007 | DISTANCE SENSOR | 9G433311077 , 6804 6475AA , 9M68-2M113-AA , C2C 39935 , 163 540 12 17 , 30665607 | |
| | | 3) Coull | 10.2013 | | 03.0655-0007.2 | 370007 | DISTANCE SENSOR | 9G433311077 , 6804 6475AA , 9M68-2M113-AA , C2C 39935 , 163 540 12 17 , 30665607 | |
| XC60 (08-) | 2,0 D3 DRIVE | 3) Coull | 03.2010 | | 03.0655-0007.2 | 370007 | DISTANCE SENSOR | 9G433311077 , 6804 6475AA , 9M68-2M113-AA , C2C 39935 , 163 540 12 17 , 30665607 | |
| | 2,0 T | 3) Coull | 03.2010 | | 03.0655-0007.2 | 370007 | DISTANCE SENSOR | 9G433311077 , 6804 6475AA , 9M68-2M113-AA , C2C 39935 , 163 540 12 17 , 30665607 | |
| | 2,4 D | 3) Coull | 04.2009 | | 03.0655-0007.2 | 370007 | DISTANCE SENSOR | 9G433311077 , 6804 6475AA , 9M68-2M113-AA , C2C 39935 , 163 540 12 17 , 30665607 | |
| | | 3) Coull | 07.2009 | | 03.0655-0007.2 | 370007 | DISTANCE SENSOR | 9G433311077 , 6804 6475AA , 9M68-2M113-AA , C2C 39935 , 163 540 12 17 , 30665607 | |
| | 2,4 D AWD | 3) Coull | 09.2008 | | 03.0655-0007.2 | 370007 | DISTANCE SENSOR | 9G433311077 , 6804 6475AA , 9M68-2M113-AA , C2C 39935 , 163 540 12 17 , 30665607 | |
| | 2,4 D5 | 3) Coull | 06.2011 | | 03.0655-0007.2 | 370007 | DISTANCE SENSOR | 9G433311077 , 6804 6475AA , 9M68-2M113-AA , C2C 39935 , 163 540 12 17 , 30665607 | |



| | | | | | | | |
|--|----------|--|--|--|--------------------|---|--|
| | i | | | | Bezeichnung | OE-Nummern zu ATE Artikelnummern | i z.B. Vorsachnummern / diverse |
|--|----------|--|--|--|--------------------|---|--|

VOLVO

| | | | | | | | | | |
|------------|------------|----------|---------|--|----------------|--------|-----------------|--|--|
| XC60 (08-) | 2,4 D5 AWD | 3) Coull | | | 03.0655-0007.2 | 370007 | DISTANCE SENSOR | 9G433311077 , 6804 6475AA , 9M68-2M113-AA , C2C 39935 , 163 540 12 17 , 30665607 | |
| | | 3) Coull | 04.2009 | | 03.0655-0007.2 | 370007 | DISTANCE SENSOR | 9G433311077 , 6804 6475AA , 9M68-2M113-AA , C2C 39935 , 163 540 12 17 , 30665607 | |
| | | 3) Coull | 06.2011 | | 03.0655-0007.2 | 370007 | DISTANCE SENSOR | 9G433311077 , 6804 6475AA , 9M68-2M113-AA , C2C 39935 , 163 540 12 17 , 30665607 | |
| | | 3) Coull | 09.2008 | | 03.0655-0007.2 | 370007 | DISTANCE SENSOR | 9G433311077 , 6804 6475AA , 9M68-2M113-AA , C2C 39935 , 163 540 12 17 , 30665607 | |
| | 3,0 T6 AWD | 3) Coull | | | 03.0655-0007.2 | 370007 | DISTANCE SENSOR | 9G433311077 , 6804 6475AA , 9M68-2M113-AA , C2C 39935 , 163 540 12 17 , 30665607 | |
| | | 3) Coull | 03.2010 | | 03.0655-0007.2 | 370007 | DISTANCE SENSOR | 9G433311077 , 6804 6475AA , 9M68-2M113-AA , C2C 39935 , 163 540 12 17 , 30665607 | |
| | | 3) Coull | 09.2008 | | 03.0655-0007.2 | 370007 | DISTANCE SENSOR | 9G433311077 , 6804 6475AA , 9M68-2M113-AA , C2C 39935 , 163 540 12 17 , 30665607 | |
| | 3,2 AWD | 3) Coull | | | 03.0655-0007.2 | 370007 | DISTANCE SENSOR | 9G433311077 , 6804 6475AA , 9M68-2M113-AA , C2C 39935 , 163 540 12 17 , 30665607 | |
| | | 3) Coull | 03.2010 | | 03.0655-0007.2 | 370007 | DISTANCE SENSOR | 9G433311077 , 6804 6475AA , 9M68-2M113-AA , C2C 39935 , 163 540 12 17 , 30665607 | |



Bezeichnung

OE-Nummern
zu ATE
Artikelnummern



z.B. Vorsachnummern /
diverse

VOLVO

| XC60 (08-) | 3,2 AWD | 3) Coull | 04.2009 | | 03.0655-0007.2 | 370007 | DISTANCE SENSOR | 9G433311077 , 6804 6475AA , 9M68-2M113-AA , C2C 39935 , 163 540 12 17 , 30665607 | |
|-----------------------------|------------|----------|---------|--|----------------|--------|-----------------|--|--|
| | D4 | 3) Coull | 10.2013 | | 03.0655-0007.2 | 370007 | DISTANCE SENSOR | 9G433311077 , 6804 6475AA , 9M68-2M113-AA , C2C 39935 , 163 540 12 17 , 30665607 | |
| | D4 AWD | 3) Coull | 10.2013 | | 03.0655-0007.2 | 370007 | DISTANCE SENSOR | 9G433311077 , 6804 6475AA , 9M68-2M113-AA , C2C 39935 , 163 540 12 17 , 30665607 | |
| | | 3) Coull | | | 03.0655-0007.2 | 370007 | DISTANCE SENSOR | 9G433311077 , 6804 6475AA , 9M68-2M113-AA , C2C 39935 , 163 540 12 17 , 30665607 | |
| | T5 | 3) Coull | 10.2013 | | 03.0655-0007.2 | 370007 | DISTANCE SENSOR | 9G433311077 , 6804 6475AA , 9M68-2M113-AA , C2C 39935 , 163 540 12 17 , 30665607 | |
| | | 3) Coull | 09.2010 | | 03.0655-0007.2 | 370007 | DISTANCE SENSOR | 9G433311077 , 6804 6475AA , 9M68-2M113-AA , C2C 39935 , 163 540 12 17 , 30665607 | |
| | T6 | 3) Coull | 10.2013 | | 03.0655-0007.2 | 370007 | DISTANCE SENSOR | 9G433311077 , 6804 6475AA , 9M68-2M113-AA , C2C 39935 , 163 540 12 17 , 30665607 | |
| XC70 II CROSS COUNTRY (07-) | 2,0 D3 | 3) Coull | 08.2011 | | 03.0655-0007.2 | 370007 | DISTANCE SENSOR | 9G433311077 , 6804 6475AA , 9M68-2M113-AA , C2C 39935 , 163 540 12 17 , 30665607 | |
| | 2,0 D3 AWD | 3) Coull | 08.2011 | | 03.0655-0007.2 | 370007 | DISTANCE SENSOR | 9G433311077 , 6804 6475AA , 9M68-2M113-AA , C2C 39935 , 163 540 12 17 , 30665607 | |









| | | | | | | | |
|--|----------|--|--|--|--------------------|---|--|
| | i | | | | Bezeichnung | OE-Nummern zu ATE Artikelnummern | i z.B. Vorsachnummern / diverse |
|--|----------|--|--|--|--------------------|---|--|

VOLVO

| | | | | | | | | | |
|-----------------------------|------------|----------|---------|--|----------------|--------|-----------------|--|--|
| XC70 II CROSS COUNTRY (07-) | 2,4 D | 3) Coull | 01.2010 | | 03.0655-0007.2 | 370007 | DISTANCE SENSOR | 9G433311077 , 6804 6475AA , 9M68-2M113-AA , C2C 39935 , 163 540 12 17 , 30665607 | |
| | 2,4 D AWD | 3) Coull | 08.2007 | | 03.0655-0007.2 | 370007 | DISTANCE SENSOR | 9G433311077 , 6804 6475AA , 9M68-2M113-AA , C2C 39935 , 163 540 12 17 , 30665607 | |
| | 2,4 D5 AWD | 3) Coull | 06.2011 | | 03.0655-0007.2 | 370007 | DISTANCE SENSOR | 9G433311077 , 6804 6475AA , 9M68-2M113-AA , C2C 39935 , 163 540 12 17 , 30665607 | |
| | | 3) Coull | 08.2007 | | 03.0655-0007.2 | 370007 | DISTANCE SENSOR | 9G433311077 , 6804 6475AA , 9M68-2M113-AA , C2C 39935 , 163 540 12 17 , 30665607 | |
| | | 3) Coull | 12.2009 | | 03.0655-0007.2 | 370007 | DISTANCE SENSOR | 9G433311077 , 6804 6475AA , 9M68-2M113-AA , C2C 39935 , 163 540 12 17 , 30665607 | |
| | 3,0 T6 AWD | 3) Coull | 01.2008 | | 03.0655-0007.2 | 370007 | DISTANCE SENSOR | 9G433311077 , 6804 6475AA , 9M68-2M113-AA , C2C 39935 , 163 540 12 17 , 30665607 | |
| | | 3) Coull | 01.2010 | | 03.0655-0007.2 | 370007 | DISTANCE SENSOR | 9G433311077 , 6804 6475AA , 9M68-2M113-AA , C2C 39935 , 163 540 12 17 , 30665607 | |
| | 3,2 | 3) Coull | 08.2007 | | 03.0655-0007.2 | 370007 | DISTANCE SENSOR | 9G433311077 , 6804 6475AA , 9M68-2M113-AA , C2C 39935 , 163 540 12 17 , 30665607 | |
| | 3,2 AWD | 3) Coull | 08.2007 | | 03.0655-0007.2 | 370007 | DISTANCE SENSOR | 9G433311077 , 6804 6475AA , 9M68-2M113-AA , C2C 39935 , 163 540 12 17 , 30665607 | |



| | | | | | | | |
|---|---|---|--|---|--------------------|---|--|
|  |  |  |  |  | Bezeichnung | OE-Nummern zu ATE Artikelnummern |  z.B. Vorsachnummern / diverse |
|---|---|---|--|---|--------------------|---|--|

VOLVO

| | | | | | | | | | |
|-----------------------------|----|---------|---------|--|----------------|--------|-----------------|---|--|
| XC70 II CROSS COUNTRY (07-) | T5 | 3) Coup | 10.2013 | | 03.0655-0007.2 | 370007 | DISTANCE SENSOR | 9G433311077 , 6804 6475AA , 9M68-2M113-AA , C2C 39935 , 163 540 12 17 , 30665607 | |
|-----------------------------|----|---------|---------|--|----------------|--------|-----------------|---|--|



13.0460-2756.2 602756

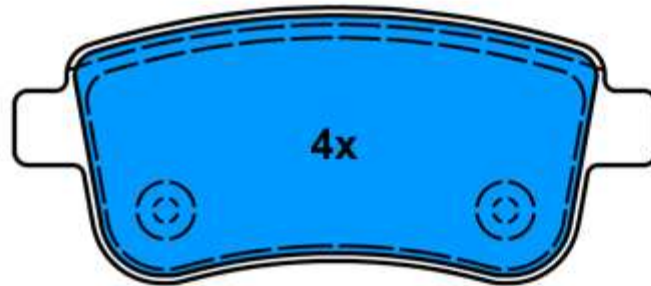
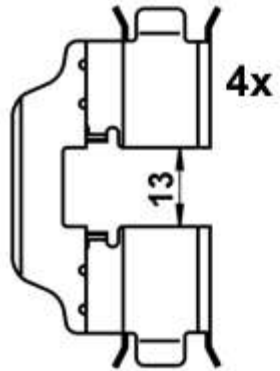

24820 16,1

106,0 x 45,3

Verwendungen:

- RENAULT MEGANE III CC (EZ0_) (10-)
- RENAULT MEGANE III Coupe (DZ0_) (08-)
- RENAULT MEGANE III Grandtour (KZ_) (08-)
- RENAULT MEGANE III Schrägheck (BZ0_) (08-)
- RENAULT SCENIC III (JZ_) (09-)



13.0460-2757.2 602757

Verwendungen:

RENAULT GRAND SCENIC (JZ_) (09-)
RENAULT SCENIC III (JZ_) (09-)

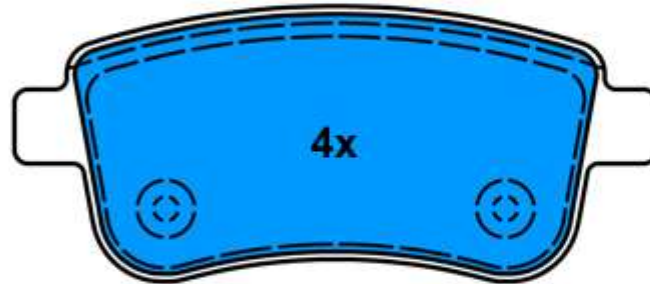
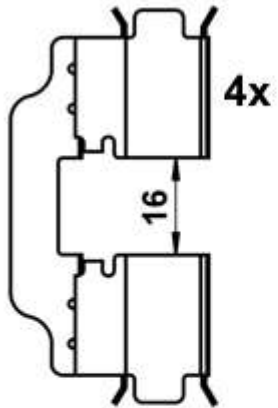

24820 16,1

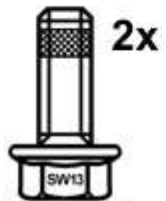

M8x22

106,0 x 45,3



13.0460-5786.2 605786

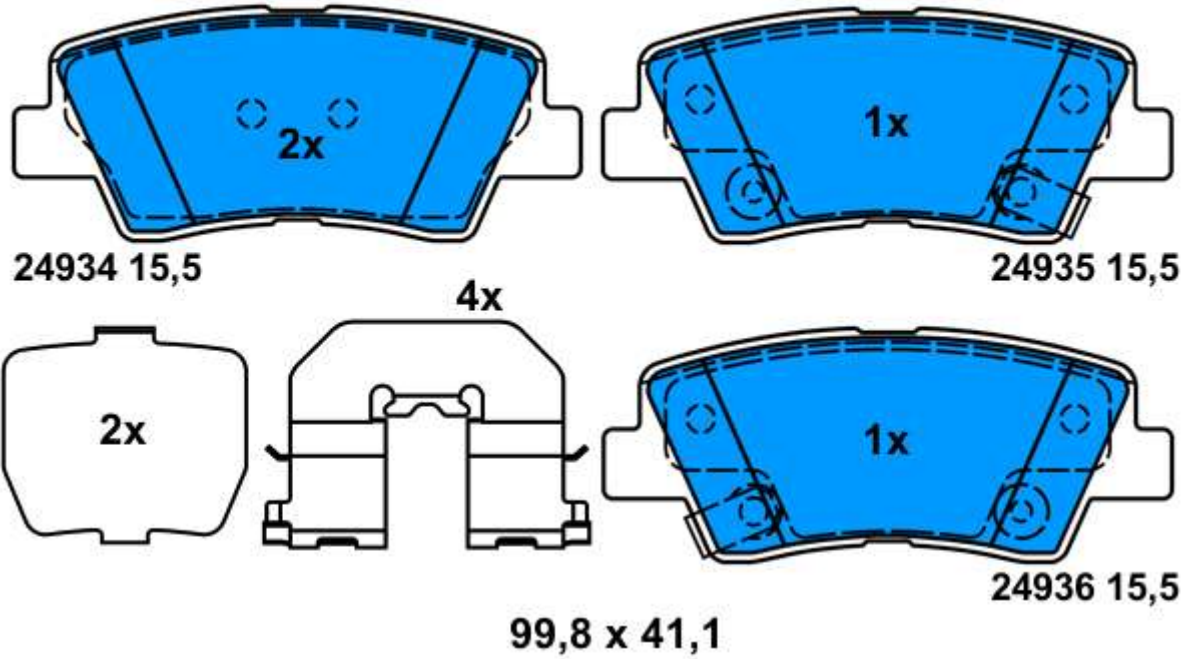

Verwendungen:

- HYUNDAI ACCENT IV (10-)
- HYUNDAI ELANTRA (11-)
- HYUNDAI i40 (12-)
- HYUNDAI i40 CW Kombi (11-)
- KIA OPTIMA (12-)
- KIA RIO III (UB) (11-)
- KIA SOUL (09-)
- HYUNDAI VELOSTER (11-)