



# Neue Teile im Lager

nach Kfz-Verwendungen

06/2015

[www.ate.de](http://www.ate.de)



Original AT  
Original AT  
Pieces d'O  
Repuestos  
Ricambi O  
Original AT



	<b>i</b>				<b>Bezeichnung</b>	<b>OE-Nummern zu ATE Artikelnummern</b>	<b>i</b> z.B. Vorsachnummern / diverse
--	----------	--	--	--	--------------------	---	--

## ALFA ROMEO

159 (05-11)	1,8 TBi	3) Coupl	05.2009	10.2011	13.0460-4867.2	604867	BELAGSATZ	77364900 , 77365202	s. Abb.
	2,0 JTDM	3) Coupl	05.2009	10.2011	13.0460-4867.2	604867	BELAGSATZ	77364900 , 77365202	s. Abb.
		3) Coupl	06.2010	10.2011	13.0460-4867.2	604867	BELAGSATZ	77364900 , 77365202	s. Abb.
BRERA (06-11)		3) Coupl	05.2009	09.2011	13.0460-4867.2	604867	BELAGSATZ	77364900 , 77365202	s. Abb.
SPIDER (06-11)		3) Coupl	04.2009	09.2011	13.0460-4867.2	604867	BELAGSATZ	77364900 , 77365202	s. Abb.
		3) Coupl	05.2009	09.2011	13.0460-4867.2	604867	BELAGSATZ	77364900 , 77365202	s. Abb.
	2,2 JTS	3) Coupl	03.2008	09.2011	13.0460-4867.2	604867	BELAGSATZ	77364900 , 77365202	s. Abb.



					<b>Bezeichnung</b>	<b>OE-Nummern zu ATE Artikelnummern</b>	 z.B. Vorsachnummern / diverse
--	--	--	--	--	--------------------	---	-----------------------------------

## AUDI

A1 / A1 Sportback (10-)	2,0 TFSI quattro	3) Coupl	10.2012		03.2125-5112.3	010966	TANDEM MASTER CYLINDE	8J1 611 021 C , 8J1 611 021 A , 8J1 611 021 E	
A3 / A3 Sportback (03-13)	RS 3	3) Coupl	04.2011	08.2013	03.2125-5112.3	010966	TANDEM MASTER CYLINDE	8J1 611 021 C , 8J1 611 021 A , 8J1 611 021 E	
A4 (B8) Avant (08-)	RS 4	3) Coupl	05.2012		13.0460-2770.2	602770	BELAGSATZ	4G0 698 451 C , 4G0 698 451 B , 4G0 698 451 A	s. Abb.
A5 Cabrio (09-)	RS 5	3) Coupl	02.2013		13.0460-2770.2	602770	BELAGSATZ	4G0 698 451 C , 4G0 698 451 B , 4G0 698 451 A	s. Abb.
A6 (4G2/C7) Limousine (11-)	1,8 TFSI	3) Coupl	09.2014		13.0460-2769.2	602769	BELAGSATZ	4G0 698 451	s. Abb.
		3) Coupl	09.2014		13.0460-2770.2	602770	BELAGSATZ	4G0 698 451 C , 4G0 698 451 B , 4G0 698 451 A	s. Abb.
	2,0 TDI	3) Coupl	01.2012		13.0460-2769.2	602769	BELAGSATZ	4G0 698 451	s. Abb.
		3) Coupl	09.2014		13.0460-2770.2	602770	BELAGSATZ	4G0 698 451 C , 4G0 698 451 B , 4G0 698 451 A	s. Abb.
		3) Coupl	04.2011		13.0460-2770.2	602770	BELAGSATZ	4G0 698 451 C , 4G0 698 451 B , 4G0 698 451 A	s. Abb.
		3) Coupl	01.2012		13.0460-2770.2	602770	BELAGSATZ	4G0 698 451 C , 4G0 698 451 B , 4G0 698 451 A	s. Abb.
		3) Coupl	09.2014		13.0460-2769.2	602769	BELAGSATZ	4G0 698 451	s. Abb.
		3) Coupl	04.2011		13.0460-2769.2	602769	BELAGSATZ	4G0 698 451	s. Abb.
	2,0 TDI quattro	3) Coupl	04.2015		13.0460-2770.2	602770	BELAGSATZ	4G0 698 451 C , 4G0 698 451 B , 4G0 698 451 A	s. Abb.
		3) Coupl	04.2015		13.0460-2769.2	602769	BELAGSATZ	4G0 698 451	s. Abb.
	2,0 TDI ultra	3) Coupl	11.2013		13.0460-2770.2	602770	BELAGSATZ	4G0 698 451 C , 4G0 698 451 B , 4G0 698 451 A	s. Abb.
		3) Coupl	11.2013		13.0460-2769.2	602769	BELAGSATZ	4G0 698 451	s. Abb.









					<b>Bezeichnung</b>	<b>OE-Nummern zu ATE Artikelnummern</b>	<b>i</b> z.B. Vorsachnummern / diverse
--	--	--	--	--	--------------------	---	---

## AUDI

A6 (4G2/C7) Limousine (11-)	2,0 TFSI	3) Coupl	05.2013		13.0460-2770.2	602770	BELAGSATZ	4G0 698 451 C , 4G0 698 451 B , 4G0 698 451 A	s. Abb.
		3) Coupl	09.2014		13.0460-2770.2	602770	BELAGSATZ	4G0 698 451 C , 4G0 698 451 B , 4G0 698 451 A	s. Abb.
		3) Coupl	04.2011		13.0460-2769.2	602769	BELAGSATZ	4G0 698 451	s. Abb.
		3) Coupl	05.2013		13.0460-2769.2	602769	BELAGSATZ	4G0 698 451	s. Abb.
		3) Coupl	09.2014		13.0460-2769.2	602769	BELAGSATZ	4G0 698 451	s. Abb.
		3) Coupl	04.2011		13.0460-2770.2	602770	BELAGSATZ	4G0 698 451 C , 4G0 698 451 B , 4G0 698 451 A	s. Abb.
	2,0 TFSI hybrid	3) Coupl	11.2011		13.0460-2769.2	602769	BELAGSATZ	4G0 698 451	s. Abb.
		3) Coupl	11.2011		13.0460-2770.2	602770	BELAGSATZ	4G0 698 451 C , 4G0 698 451 B , 4G0 698 451 A	s. Abb.
	2,0 TFSI quattro	3) Coupl	05.2013		13.0460-2770.2	602770	BELAGSATZ	4G0 698 451 C , 4G0 698 451 B , 4G0 698 451 A	s. Abb.
		3) Coupl	05.2012		13.0460-2770.2	602770	BELAGSATZ	4G0 698 451 C , 4G0 698 451 B , 4G0 698 451 A	s. Abb.
		3) Coupl	05.2012		13.0460-2769.2	602769	BELAGSATZ	4G0 698 451	s. Abb.
		3) Coupl	05.2013		13.0460-2769.2	602769	BELAGSATZ	4G0 698 451	s. Abb.
	2,8 FSI	3) Coupl	04.2011		13.0460-2769.2	602769	BELAGSATZ	4G0 698 451	s. Abb.
		3) Coupl	04.2011		13.0460-2770.2	602770	BELAGSATZ	4G0 698 451 C , 4G0 698 451 B , 4G0 698 451 A	s. Abb.
	2,8 FSI quattro	3) Coupl	04.2011		13.0460-2770.2	602770	BELAGSATZ	4G0 698 451 C , 4G0 698 451 B , 4G0 698 451 A	s. Abb.
		3) Coupl	04.2011		13.0460-2769.2	602769	BELAGSATZ	4G0 698 451	s. Abb.
	3,0 TDI	3) Coupl	09.2014		13.0460-2770.2	602770	BELAGSATZ	4G0 698 451 C , 4G0 698 451 B , 4G0 698 451 A	s. Abb.







					<b>Bezeichnung</b>	<b>OE-Nummern zu ATE Artikelnummern</b>	 <b>z.B. Vorsachnummern / diverse</b>
---	---	---	--	---	--------------------	---	---

## AUDI

A6 (4G2/C7) Limousine (11-)	3,0 TDI	3) Coull	04.2011		13.0460-2769.2	602769	BELAGSATZ	4G0 698 451	s. Abb.
		3) Coull	09.2014		13.0460-2769.2	602769	BELAGSATZ	4G0 698 451	s. Abb.
		3) Coull	04.2011		13.0460-2770.2	602770	BELAGSATZ	4G0 698 451 C , 4G0 698 451 B , 4G0 698 451 A	s. Abb.
	3,0 TDI quattro	3) Coull	04.2011		13.0460-2770.2	602770	BELAGSATZ	4G0 698 451 C , 4G0 698 451 B , 4G0 698 451 A	s. Abb.
		3) Coull	12.2011		13.0460-2770.2	602770	BELAGSATZ	4G0 698 451 C , 4G0 698 451 B , 4G0 698 451 A	s. Abb.
		3) Coull	09.2014		13.0460-2770.2	602770	BELAGSATZ	4G0 698 451 C , 4G0 698 451 B , 4G0 698 451 A	s. Abb.
		3) Coull	05.2013		13.0460-2770.2	602770	BELAGSATZ	4G0 698 451 C , 4G0 698 451 B , 4G0 698 451 A	s. Abb.
		3) Coull	04.2011		13.0460-2769.2	602769	BELAGSATZ	4G0 698 451	s. Abb.
		3) Coull	05.2013		13.0460-2769.2	602769	BELAGSATZ	4G0 698 451	s. Abb.
		3) Coull	12.2011		13.0460-2769.2	602769	BELAGSATZ	4G0 698 451	s. Abb.
		3) Coull	09.2014		13.0460-2769.2	602769	BELAGSATZ	4G0 698 451	s. Abb.
	3,0 TFSI quattro	3) Coull	04.2011		13.0460-2770.2	602770	BELAGSATZ	4G0 698 451 C , 4G0 698 451 B , 4G0 698 451 A	s. Abb.
		3) Coull	09.2014		13.0460-2769.2	602769	BELAGSATZ	4G0 698 451	s. Abb.
		3) Coull	04.2011		13.0460-2769.2	602769	BELAGSATZ	4G0 698 451	s. Abb.
		3) Coull	09.2014		13.0460-2770.2	602770	BELAGSATZ	4G0 698 451 C , 4G0 698 451 B , 4G0 698 451 A	s. Abb.
	S6	3) Coull	10.2014		13.0460-2769.2	602769	BELAGSATZ	4G0 698 451	s. Abb.
		3) Coull	04.2012		13.0460-2769.2	602769	BELAGSATZ	4G0 698 451	s. Abb.









					<b>Bezeichnung</b>	<b>OE-Nummern zu ATE Artikelnummern</b>	 <b>z.B. Vorsachnummern / diverse</b>
---	---	---	--	---	--------------------	---	---

## AUDI

A6 (4G2/C7) Limousine (11-)	S6	3) Coull	04.2012		13.0460-2770.2	602770	BELAGSATZ	4G0 698 451 C , 4G0 698 451 B , 4G0 698 451 A	s. Abb.
		3) Coull	10.2014		13.0460-2770.2	602770	BELAGSATZ	4G0 698 451 C , 4G0 698 451 B , 4G0 698 451 A	s. Abb.
A6 (4G5/C7) Avant (11-)	1,8 TFSI	3) Coull	09.2014		13.0460-2769.2	602769	BELAGSATZ	4G0 698 451	s. Abb.
		3) Coull	09.2014		13.0460-2770.2	602770	BELAGSATZ	4G0 698 451 C , 4G0 698 451 B , 4G0 698 451 A	s. Abb.
	2,0 TDI	3) Coull	09.2011		13.0460-2770.2	602770	BELAGSATZ	4G0 698 451 C , 4G0 698 451 B , 4G0 698 451 A	s. Abb.
		3) Coull	09.2014		13.0460-2770.2	602770	BELAGSATZ	4G0 698 451 C , 4G0 698 451 B , 4G0 698 451 A	s. Abb.
		3) Coull	09.2011		13.0460-2769.2	602769	BELAGSATZ	4G0 698 451	s. Abb.
		3) Coull	09.2014		13.0460-2769.2	602769	BELAGSATZ	4G0 698 451	s. Abb.
		3) Coull	01.2012		13.0460-2770.2	602770	BELAGSATZ	4G0 698 451 C , 4G0 698 451 B , 4G0 698 451 A	s. Abb.
		3) Coull	01.2012		13.0460-2769.2	602769	BELAGSATZ	4G0 698 451	s. Abb.
	2,0 TDI quattro	3) Coull	04.2015		13.0460-2769.2	602769	BELAGSATZ	4G0 698 451	s. Abb.
		3) Coull	04.2015		13.0460-2770.2	602770	BELAGSATZ	4G0 698 451 C , 4G0 698 451 B , 4G0 698 451 A	s. Abb.
	2,0 TDI ultra	3) Coull	11.2013		13.0460-2770.2	602770	BELAGSATZ	4G0 698 451 C , 4G0 698 451 B , 4G0 698 451 A	s. Abb.
		3) Coull	11.2013		13.0460-2769.2	602769	BELAGSATZ	4G0 698 451	s. Abb.
	2,0 TFSI	3) Coull	09.2014		13.0460-2769.2	602769	BELAGSATZ	4G0 698 451	s. Abb.
		3) Coull	06.2011		13.0460-2769.2	602769	BELAGSATZ	4G0 698 451	s. Abb.
		3) Coull	06.2011		13.0460-2770.2	602770	BELAGSATZ	4G0 698 451 C , 4G0 698 451 B , 4G0 698 451 A	s. Abb.







					<b>Bezeichnung</b>	<b>OE-Nummern zu ATE Artikelnummern</b>	 <b>z.B. Vorsachnummern / diverse</b>
---	---	---	--	---	--------------------	---	---

## AUDI

A6 (4G5/C7) Avant (11-)	2,0 TFSI	3) Coull	09.2014		13.0460-2770.2	602770	BELAGSATZ	4G0 698 451 C , 4G0 698 451 B , 4G0 698 451 A	s. Abb.
	2,8 FSI	3) Coull	09.2011		13.0460-2769.2	602769	BELAGSATZ	4G0 698 451	s. Abb.
		3) Coull	09.2011		13.0460-2770.2	602770	BELAGSATZ	4G0 698 451 C , 4G0 698 451 B , 4G0 698 451 A	s. Abb.
	2,8 FSI quattro	3) Coull	09.2011		13.0460-2770.2	602770	BELAGSATZ	4G0 698 451 C , 4G0 698 451 B , 4G0 698 451 A	s. Abb.
		3) Coull	09.2011		13.0460-2769.2	602769	BELAGSATZ	4G0 698 451	s. Abb.
	3,0 TDI	3) Coull	09.2011		13.0460-2770.2	602770	BELAGSATZ	4G0 698 451 C , 4G0 698 451 B , 4G0 698 451 A	s. Abb.
		3) Coull	09.2014		13.0460-2770.2	602770	BELAGSATZ	4G0 698 451 C , 4G0 698 451 B , 4G0 698 451 A	s. Abb.
		3) Coull	09.2014		13.0460-2769.2	602769	BELAGSATZ	4G0 698 451	s. Abb.
		3) Coull	09.2011		13.0460-2769.2	602769	BELAGSATZ	4G0 698 451	s. Abb.
	3,0 TDI quattro	3) Coull	12.2011		13.0460-2769.2	602769	BELAGSATZ	4G0 698 451	s. Abb.
		3) Coull	09.2011		13.0460-2769.2	602769	BELAGSATZ	4G0 698 451	s. Abb.
		3) Coull	09.2014		13.0460-2769.2	602769	BELAGSATZ	4G0 698 451	s. Abb.
		3) Coull	09.2014		13.0460-2770.2	602770	BELAGSATZ	4G0 698 451 C , 4G0 698 451 B , 4G0 698 451 A	s. Abb.
		3) Coull	12.2011		13.0460-2770.2	602770	BELAGSATZ	4G0 698 451 C , 4G0 698 451 B , 4G0 698 451 A	s. Abb.
		3) Coull	09.2011		13.0460-2770.2	602770	BELAGSATZ	4G0 698 451 C , 4G0 698 451 B , 4G0 698 451 A	s. Abb.
	3,0 TFSI quattro	3) Coull	09.2011		13.0460-2769.2	602769	BELAGSATZ	4G0 698 451	s. Abb.
		3) Coull	09.2014		13.0460-2769.2	602769	BELAGSATZ	4G0 698 451	s. Abb.









					<b>Bezeichnung</b>	<b>OE-Nummern zu ATE Artikelnummern</b>	 <b>z.B. Vorsachnummern / diverse</b>
---	---	---	--	---	--------------------	---	---

## AUDI

A6 (4G5/C7) Avant (11-)	3,0 TFSI quattro	3) Coull	09.2011		13.0460-2770.2	602770	BELAGSATZ	4G0 698 451 C , 4G0 698 451 B , 4G0 698 451 A	s. Abb.
		3) Coull	09.2014		13.0460-2770.2	602770	BELAGSATZ	4G0 698 451 C , 4G0 698 451 B , 4G0 698 451 A	s. Abb.
	RS 6	3) Coull	03.2013		13.0460-2770.2	602770	BELAGSATZ	4G0 698 451 C , 4G0 698 451 B , 4G0 698 451 A	s. Abb.
	S6	3) Coull	04.2012		13.0460-2770.2	602770	BELAGSATZ	4G0 698 451 C , 4G0 698 451 B , 4G0 698 451 A	s. Abb.
		3) Coull	04.2012		13.0460-2769.2	602769	BELAGSATZ	4G0 698 451	s. Abb.
		3) Coull	09.2014		13.0460-2769.2	602769	BELAGSATZ	4G0 698 451	s. Abb.
		3) Coull	09.2014		13.0460-2770.2	602770	BELAGSATZ	4G0 698 451 C , 4G0 698 451 B , 4G0 698 451 A	s. Abb.
A6 Allroad (12-)	3,0 TDI quattro	3) Coull	01.2012		13.0460-2770.2	602770	BELAGSATZ	4G0 698 451 C , 4G0 698 451 B , 4G0 698 451 A	s. Abb.
		3) Coull	09.2014		13.0460-2770.2	602770	BELAGSATZ	4G0 698 451 C , 4G0 698 451 B , 4G0 698 451 A	s. Abb.
	3,0 TFSI quattro	3) Coull	01.2012		13.0460-2770.2	602770	BELAGSATZ	4G0 698 451 C , 4G0 698 451 B , 4G0 698 451 A	s. Abb.
		3) Coull	09.2014		13.0460-2770.2	602770	BELAGSATZ	4G0 698 451 C , 4G0 698 451 B , 4G0 698 451 A	s. Abb.
A7 Sportback (10-)	2,0 TFSI	3) Coull	09.2014		13.0460-2769.2	602769	BELAGSATZ	4G0 698 451	s. Abb.
		3) Coull	09.2014		13.0460-2770.2	602770	BELAGSATZ	4G0 698 451 C , 4G0 698 451 B , 4G0 698 451 A	s. Abb.
	2,8 FSI	3) Coull	05.2011		13.0460-2770.2	602770	BELAGSATZ	4G0 698 451 C , 4G0 698 451 B , 4G0 698 451 A	s. Abb.
		3) Coull	05.2011		13.0460-2769.2	602769	BELAGSATZ	4G0 698 451	s. Abb.
	2,8 FSI quattro	3) Coull	07.2010		13.0460-2770.2	602770	BELAGSATZ	4G0 698 451 C , 4G0 698 451 B , 4G0 698 451 A	s. Abb.





					<b>Bezeichnung</b>	<b>OE-Nummern zu ATE Artikelnummern</b>	 <b>z.B. Vorsachnummern / diverse</b>
---	---	---	--	---	--------------------	---	---

## AUDI

A7 Sportback (10-)	2,8 FSI quattro	3) Cou	07.2010		13.0460-2769.2	602769	BELAGSATZ	4G0 698 451	s. Abb.
	3,0 TDI	3) Cou	11.2010		13.0460-2769.2	602769	BELAGSATZ	4G0 698 451	s. Abb.
		3) Cou	11.2010		13.0460-2770.2	602770	BELAGSATZ	4G0 698 451 C , 4G0 698 451 B , 4G0 698 451 A	s. Abb.
	3,0 TDI quattro	3) Cou	07.2010		13.0460-2769.2	602769	BELAGSATZ	4G0 698 451	s. Abb.
		3) Cou	08.2014		13.0460-2769.2	602769	BELAGSATZ	4G0 698 451	s. Abb.
		3) Cou	05.2014		13.0460-2769.2	602769	BELAGSATZ	4G0 698 451	s. Abb.
		3) Cou	11.2011		13.0460-2769.2	602769	BELAGSATZ	4G0 698 451	s. Abb.
		3) Cou	05.2013		13.0460-2769.2	602769	BELAGSATZ	4G0 698 451	s. Abb.
		3) Cou	05.2013		13.0460-2770.2	602770	BELAGSATZ	4G0 698 451 C , 4G0 698 451 B , 4G0 698 451 A	s. Abb.
		3) Cou	05.2014		13.0460-2770.2	602770	BELAGSATZ	4G0 698 451 C , 4G0 698 451 B , 4G0 698 451 A	s. Abb.
		3) Cou	07.2010		13.0460-2770.2	602770	BELAGSATZ	4G0 698 451 C , 4G0 698 451 B , 4G0 698 451 A	s. Abb.
		3) Cou	08.2014		13.0460-2770.2	602770	BELAGSATZ	4G0 698 451 C , 4G0 698 451 B , 4G0 698 451 A	s. Abb.
		3) Cou	11.2011		13.0460-2770.2	602770	BELAGSATZ	4G0 698 451 C , 4G0 698 451 B , 4G0 698 451 A	s. Abb.
	3,0 TDI ultra	3) Cou	05.2014		13.0460-2770.2	602770	BELAGSATZ	4G0 698 451 C , 4G0 698 451 B , 4G0 698 451 A	s. Abb.
		3) Cou	05.2014		13.0460-2769.2	602769	BELAGSATZ	4G0 698 451	s. Abb.
	3,0 TFSI quattro	3) Cou	07.2010		13.0460-2769.2	602769	BELAGSATZ	4G0 698 451	s. Abb.
		3) Cou	05.2014		13.0460-2770.2	602770	BELAGSATZ	4G0 698 451 C , 4G0 698 451 B , 4G0 698 451 A	s. Abb.







					<b>Bezeichnung</b>	<b>OE-Nummern zu ATE Artikelnummern</b>	 z.B. Vorsachnummern / diverse
--	--	--	--	--	--------------------	---	--------------------------------------

## AUDI

A7 Sportback (10-)	3,0 TFSI quattro	3) Coull	07.2010		13.0460-2770.2	602770	BELAGSATZ	4G0 698 451 C , 4G0 698 451 B , 4G0 698 451 A	s. Abb.
		3) Coull	05.2014		13.0460-2769.2	602769	BELAGSATZ	4G0 698 451	s. Abb.
	RS 7	3) Coull	10.2013		13.0460-2770.2	602770	BELAGSATZ	4G0 698 451 C , 4G0 698 451 B , 4G0 698 451 A	s. Abb.
	S7	3) Coull	05.2014		13.0460-2769.2	602769	BELAGSATZ	4G0 698 451	s. Abb.
		3) Coull	10.2011		13.0460-2769.2	602769	BELAGSATZ	4G0 698 451	s. Abb.
		3) Coull	10.2011		13.0460-2770.2	602770	BELAGSATZ	4G0 698 451 C , 4G0 698 451 B , 4G0 698 451 A	s. Abb.
		3) Coull	05.2014		13.0460-2770.2	602770	BELAGSATZ	4G0 698 451 C , 4G0 698 451 B , 4G0 698 451 A	s. Abb.
A8 (09-)	2,0 TFSI hybrid	3) Coull	05.2012		13.0460-2773.2	602773	BELAGSATZ	4H0 698 451 A , 4H0 698 451 D , 4H0 698 451 C	s. Abb.
	3,0 TDI	3) Coull	09.2011		13.0460-2773.2	602773	BELAGSATZ	4H0 698 451 A , 4H0 698 451 D , 4H0 698 451 C	s. Abb.
	3,0 TDI quattro	3) Coull	09.2013		13.0460-2773.2	602773	BELAGSATZ	4H0 698 451 A , 4H0 698 451 D , 4H0 698 451 C	s. Abb.
		3) Coull	07.2010		13.0460-2773.2	602773	BELAGSATZ	4H0 698 451 A , 4H0 698 451 D , 4H0 698 451 C	s. Abb.
	3,0 TFSI quattro	3) Coull	07.2010		13.0460-2773.2	602773	BELAGSATZ	4H0 698 451 A , 4H0 698 451 D , 4H0 698 451 C	s. Abb.
	4,0 TFSI quattro	3) Coull	09.2013		13.0460-2773.2	602773	BELAGSATZ	4H0 698 451 A , 4H0 698 451 D , 4H0 698 451 C	s. Abb.
		3) Coull	03.2012		13.0460-2773.2	602773	BELAGSATZ	4H0 698 451 A , 4H0 698 451 D , 4H0 698 451 C	s. Abb.
	4,2 FSI quattro	3) Coull	11.2009		13.0460-2773.2	602773	BELAGSATZ	4H0 698 451 A , 4H0 698 451 D , 4H0 698 451 C	s. Abb.



					<b>Bezeichnung</b>	<b>OE-Nummern zu ATE Artikelnummern</b>	 z.B. Vorsachnummern / diverse
---	---	---	--	---	--------------------	---	---

## AUDI

A8 (09-)	4,2 TDI quattro	3) Coull	11.2009		13.0460-2773.2	602773	BELAGSATZ	4H0 698 451 A , 4H0 698 451 D , 4H0 698 451 C	s. Abb.
		3) Coull	09.2013		13.0460-2773.2	602773	BELAGSATZ	4H0 698 451 A , 4H0 698 451 D , 4H0 698 451 C	s. Abb.
	6,3 W12 quattro	3) Coull	01.2011		13.0460-2773.2	602773	BELAGSATZ	4H0 698 451 A , 4H0 698 451 D , 4H0 698 451 C	s. Abb.
	S8	3) Coull	04.2012		13.0460-2773.2	602773	BELAGSATZ	4H0 698 451 A , 4H0 698 451 D , 4H0 698 451 C	s. Abb.
Q3 (11-)	RS 2,5	3) Coull	03.2015		03.2125-5112.3	010966	TANDEM MASTER CYLINDE	8J1 611 021 C , 8J1 611 021 A , 8J1 611 021 E	
		3) Coull	09.2013		03.2125-5112.3	010966	TANDEM MASTER CYLINDE	8J1 611 021 C , 8J1 611 021 A , 8J1 611 021 E	
TT Coupe (06-14)	3,2 quattro	3) Coull	07.2006	06.2014	03.2125-5112.3	010966	TANDEM MASTER CYLINDE	8J1 611 021 C , 8J1 611 021 A , 8J1 611 021 E	
	RS 2,5 TFSI	3) Coull	05.2009	06.2014	03.2125-5112.3	010966	TANDEM MASTER CYLINDE	8J1 611 021 C , 8J1 611 021 A , 8J1 611 021 E	
	RS 2,5 TFSI plus	3) Coull	05.2011	06.2014	03.2125-5112.3	010966	TANDEM MASTER CYLINDE	8J1 611 021 C , 8J1 611 021 A , 8J1 611 021 E	
	TTS 2,0 TFSI	3) Coull	05.2008	06.2014	03.2125-5112.3	010966	TANDEM MASTER CYLINDE	8J1 611 021 C , 8J1 611 021 A , 8J1 611 021 E	
TT Roadster (07-14)	3,2 quattro	3) Coull	02.2007	06.2014	03.2125-5112.3	010966	TANDEM MASTER CYLINDE	8J1 611 021 C , 8J1 611 021 A , 8J1 611 021 E	
	RS 2,5 TFSI	3) Coull	05.2009	06.2014	03.2125-5112.3	010966	TANDEM MASTER CYLINDE	8J1 611 021 C , 8J1 611 021 A , 8J1 611 021 E	
	RS 2,5 TFSI plus	3) Coull	02.2012	06.2014	03.2125-5112.3	010966	TANDEM MASTER CYLINDE	8J1 611 021 C , 8J1 611 021 A , 8J1 611 021 E	
	TTS 2,0 TFSI	3) Coull	05.2008	06.2014	03.2125-5112.3	010966	TANDEM MASTER CYLINDE	8J1 611 021 C , 8J1 611 021 A , 8J1 611 021 E	



					<b>Bezeichnung</b>	<b>OE-Nummern zu ATE Artikelnummern</b>	 z.B. Vorsachnummern / diverse
--	--	--	--	--	--------------------	---	-----------------------------------

## BMW

1er Reihe/F20/F21 Limousine (11-)	114 d	3) Cour	10.2012	24.0130-0233.2	430233	2-PIECE BRAKE DISC	34 11 6 792 223	
		3) Cour	10.2012	13.0460-4874.2	604874	BELAGSATZ	34 21 6 855 474	s. Abb.
		VA	10.2012	24.0711-6282.3	360387	RADSENSOR	34 52 6 869 320 , 34 52 6 791 224	
	114 i	3) Cour	09.2012	24.0130-0233.2	430233	2-PIECE BRAKE DISC	34 11 6 792 223	
		3) Cour	09.2012	13.0460-4874.2	604874	BELAGSATZ	34 21 6 855 474	s. Abb.
		VA	09.2012	24.0711-6282.3	360387	RADSENSOR	34 52 6 869 320 , 34 52 6 791 224	
	116 d	3) Cour	03.2015	24.0130-0233.2	430233	2-PIECE BRAKE DISC	34 11 6 792 223	
		3) Cour	03.2015	13.0460-4874.2	604874	BELAGSATZ	34 21 6 855 474	s. Abb.
		VA	03.2015	24.0711-6282.3	360387	RADSENSOR	34 52 6 869 320 , 34 52 6 791 224	
		VA	06.2011	24.0711-6282.3	360387	RADSENSOR	34 52 6 869 320 , 34 52 6 791 224	
	116 d ed	VA	03.2012	24.0711-6282.3	360387	RADSENSOR	34 52 6 869 320 , 34 52 6 791 224	
	116 i	3) Cour	03.2015	24.0130-0233.2	430233	2-PIECE BRAKE DISC	34 11 6 792 223	
		3) Cour	03.2015	13.0460-4874.2	604874	BELAGSATZ	34 21 6 855 474	s. Abb.
		VA	06.2011	24.0711-6282.3	360387	RADSENSOR	34 52 6 869 320 , 34 52 6 791 224	
		VA	03.2015	24.0711-6282.3	360387	RADSENSOR	34 52 6 869 320 , 34 52 6 791 224	
	118 d	3) Cour	03.2015	24.0130-0233.2	430233	2-PIECE BRAKE DISC	34 11 6 792 223	
		3) Cour	03.2015	13.0460-4874.2	604874	BELAGSATZ	34 21 6 855 474	s. Abb.



					<b>Bezeichnung</b>	<b>OE-Nummern zu ATE Artikelnummern</b>	<b>i</b> z.B. Vorsachnummern / diverse
--	--	--	--	--	--------------------	---	---

## BMW

1er Reihe/F20/F21 Limousine (11-)	118 d	VA	03.2015		24.0711-6282.3	360387	RADSENSOR	34 52 6 869 320 , 34 52 6 791 224	
		VA	06.2011		24.0711-6282.3	360387	RADSENSOR	34 52 6 869 320 , 34 52 6 791 224	
	118 d xDrive	3) Coull	05.2013		24.0130-0233.2	430233	2-PIECE BRAKE DISC	34 11 6 792 223	
		3) Coull	03.2015		24.0130-0233.2	430233	2-PIECE BRAKE DISC	34 11 6 792 223	
		3) Coull	05.2013		13.0460-3866.2	603866	BELAGSATZ	34 11 6 850 568	s. Abb.
		3) Coull	03.2015		13.0460-4874.2	604874	BELAGSATZ	34 21 6 855 474	s. Abb.
		3) Coull	05.2013		13.0460-4874.2	604874	BELAGSATZ	34 21 6 855 474	s. Abb.
	118 i	3) Coull	03.2015		24.0130-0233.2	430233	2-PIECE BRAKE DISC	34 11 6 792 223	
		3) Coull	03.2015		13.0460-4874.2	604874	BELAGSATZ	34 21 6 855 474	s. Abb.
		3) Coull	06.2011		13.0460-3866.2	603866	BELAGSATZ	34 11 6 850 568	s. Abb.
		VA	06.2011		24.0711-6282.3	360387	RADSENSOR	34 52 6 869 320 , 34 52 6 791 224	
		VA	03.2015		24.0711-6282.3	360387	RADSENSOR	34 52 6 869 320 , 34 52 6 791 224	
	120 d	3) Coull	03.2015		24.0130-0233.2	430233	2-PIECE BRAKE DISC	34 11 6 792 223	
		3) Coull	03.2015		13.0460-3866.2	603866	BELAGSATZ	34 11 6 850 568	s. Abb.
		3) Coull	06.2011		13.0460-3866.2	603866	BELAGSATZ	34 11 6 850 568	s. Abb.
		3) Coull	03.2015		13.0460-4874.2	604874	BELAGSATZ	34 21 6 855 474	s. Abb.
		VA	03.2015		24.0711-6282.3	360387	RADSENSOR	34 52 6 869 320 , 34 52 6 791 224	
		VA	06.2011		24.0711-6282.3	360387	RADSENSOR	34 52 6 869 320 , 34 52 6 791 224	



					<b>Bezeichnung</b>	<b>OE-Nummern zu ATE Artikelnummern</b>	 z.B. Vorsachnummern / diverse
--	--	--	--	--	--------------------	---	--------------------------------------

## BMW

1er Reihe/F20/F21 Limousine (11-)	120 d xDrive	3) Coull	07.2012		24.0130-0233.2	430233	2-PIECE BRAKE DISC	34 11 6 792 223	
		3) Coull	03.2015		24.0130-0233.2	430233	2-PIECE BRAKE DISC	34 11 6 792 223	
		3) Coull	07.2012		13.0460-3866.2	603866	BELAGSATZ	34 11 6 850 568	s. Abb.
		3) Coull	07.2012		13.0460-4874.2	604874	BELAGSATZ	34 21 6 855 474	s. Abb.
		3) Coull	03.2015		13.0460-4874.2	604874	BELAGSATZ	34 21 6 855 474	s. Abb.
		3) Coull	03.2015		13.0460-3866.2	603866	BELAGSATZ	34 11 6 850 568	s. Abb.
	120 i	3) Coull	03.2015		13.0460-3866.2	603866	BELAGSATZ	34 11 6 850 568	s. Abb.
		3) Coull	03.2015		13.0460-4874.2	604874	BELAGSATZ	34 21 6 855 474	s. Abb.
		VA	03.2015		24.0711-6282.3	360387	RADSENSOR	34 52 6 869 320 , 34 52 6 791 224	
	125 d	3) Coull	03.2015		24.0130-0233.2	430233	2-PIECE BRAKE DISC	34 11 6 792 223	
		3) Coull	03.2012		24.0130-0233.2	430233	2-PIECE BRAKE DISC	34 11 6 792 223	
		3) Coull	03.2012		13.0460-4874.2	604874	BELAGSATZ	34 21 6 855 474	s. Abb.
		3) Coull	03.2015		13.0460-4874.2	604874	BELAGSATZ	34 21 6 855 474	s. Abb.
		VA	03.2012		24.0711-6282.3	360387	RADSENSOR	34 52 6 869 320 , 34 52 6 791 224	
		VA	03.2015		24.0711-6282.3	360387	RADSENSOR	34 52 6 869 320 , 34 52 6 791 224	
	125 i	3) Coull	03.2012		24.0130-0233.2	430233	2-PIECE BRAKE DISC	34 11 6 792 223	
		3) Coull	03.2012		13.0460-4874.2	604874	BELAGSATZ	34 21 6 855 474	s. Abb.
		VA	03.2012		24.0711-6282.3	360387	RADSENSOR	34 52 6 869 320 , 34 52 6 791 224	
	M 135 i	3) Coull	09.2012		24.0130-0233.2	430233	2-PIECE BRAKE DISC	34 11 6 792 223	



					<b>Bezeichnung</b>	<b>OE-Nummern zu ATE Artikelnummern</b>	 z.B. Vorsachnummern / diverse
--	--	--	--	--	--------------------	---	--------------------------------------

## BMW

1er Reihe/F20/F21 Limousine (11-)	M 135 i	3) Coupl	03.2015		24.0130-0233.2	430233	2-PIECE BRAKE DISC	34 11 6 792 223	
		3) Coupl	03.2015		13.0460-4874.2	604874	BELAGSATZ	34 21 6 855 474	s. Abb.
		3) Coupl	09.2012		13.0460-4874.2	604874	BELAGSATZ	34 21 6 855 474	s. Abb.
		VA	03.2015		24.0711-6282.3	360387	RADSENSOR	34 52 6 869 320 , 34 52 6 791 224	
		VA	09.2012		24.0711-6282.3	360387	RADSENSOR	34 52 6 869 320 , 34 52 6 791 224	
	M 135 i xDrive	3) Coupl	07.2012		24.0130-0233.2	430233	2-PIECE BRAKE DISC	34 11 6 792 223	
		3) Coupl	03.2015		24.0130-0233.2	430233	2-PIECE BRAKE DISC	34 11 6 792 223	
		3) Coupl	07.2012		13.0460-4874.2	604874	BELAGSATZ	34 21 6 855 474	s. Abb.
		3) Coupl	03.2015		13.0460-4874.2	604874	BELAGSATZ	34 21 6 855 474	s. Abb.
2er Reihe/F22 Coupe (13-)	218 d	3) Coupl	10.2013		24.0130-0233.2	430233	2-PIECE BRAKE DISC	34 11 6 792 223	
		3) Coupl	10.2013		13.0460-4874.2	604874	BELAGSATZ	34 21 6 855 474	s. Abb.
		VA	10.2013		24.0711-6282.3	360387	RADSENSOR	34 52 6 869 320 , 34 52 6 791 224	
	218 i	3) Coupl	03.2015		24.0130-0233.2	430233	2-PIECE BRAKE DISC	34 11 6 792 223	
		3) Coupl	03.2015		13.0460-4874.2	604874	BELAGSATZ	34 21 6 855 474	s. Abb.
		VA	03.2015		24.0711-6282.3	360387	RADSENSOR	34 52 6 869 320 , 34 52 6 791 224	
	220 d	3) Coupl	10.2013		24.0130-0233.2	430233	2-PIECE BRAKE DISC	34 11 6 792 223	
		3) Coupl	11.2014		24.0130-0233.2	430233	2-PIECE BRAKE DISC	34 11 6 792 223	
		3) Coupl	11.2014		13.0460-4874.2	604874	BELAGSATZ	34 21 6 855 474	s. Abb.
		3) Coupl	10.2013		13.0460-4874.2	604874	BELAGSATZ	34 21 6 855 474	s. Abb.





					<b>Bezeichnung</b>	<b>OE-Nummern zu ATE Artikelnummern</b>	 z.B. Vorsachnummern / diverse
--	--	--	--	--	--------------------	---	--------------------------------------

## BMW

2er Reihe/F22 Coupe (13-)	220 d	VA	11.2014		24.0711-6282.3	360387	RADSENSOR	34 52 6 869 320 , 34 52 6 791 224	
		VA	10.2013		24.0711-6282.3	360387	RADSENSOR	34 52 6 869 320 , 34 52 6 791 224	
	220 d xDrive	3) Coull	03.2015		24.0130-0233.2	430233	2-PIECE BRAKE DISC	34 11 6 792 223	
		3) Coull	03.2015		13.0460-4874.2	604874	BELAGSATZ	34 21 6 855 474	s. Abb.
	220 i	3) Coull	10.2013		24.0130-0233.2	430233	2-PIECE BRAKE DISC	34 11 6 792 223	
		3) Coull	10.2013		13.0460-4874.2	604874	BELAGSATZ	34 21 6 855 474	s. Abb.
		VA	10.2013		24.0711-6282.3	360387	RADSENSOR	34 52 6 869 320 , 34 52 6 791 224	
	225 d	3) Coull	10.2013		24.0130-0233.2	430233	2-PIECE BRAKE DISC	34 11 6 792 223	
		3) Coull	10.2013		13.0460-4874.2	604874	BELAGSATZ	34 21 6 855 474	s. Abb.
		VA	10.2013		24.0711-6282.3	360387	RADSENSOR	34 52 6 869 320 , 34 52 6 791 224	
	228 i	3) Coull	07.2014		24.0130-0233.2	430233	2-PIECE BRAKE DISC	34 11 6 792 223	
		3) Coull	07.2014		13.0460-4874.2	604874	BELAGSATZ	34 21 6 855 474	s. Abb.
		VA	07.2014		24.0711-6282.3	360387	RADSENSOR	34 52 6 869 320 , 34 52 6 791 224	
	M 235 i	3) Coull	10.2013		24.0130-0233.2	430233	2-PIECE BRAKE DISC	34 11 6 792 223	
		3) Coull	10.2013		13.0460-4874.2	604874	BELAGSATZ	34 21 6 855 474	s. Abb.
		VA	10.2013		24.0711-6282.3	360387	RADSENSOR	34 52 6 869 320 , 34 52 6 791 224	
	M 235 i xDrive	3) Coull	07.2014		24.0130-0233.2	430233	2-PIECE BRAKE DISC	34 11 6 792 223	
		3) Coull	07.2014		13.0460-4874.2	604874	BELAGSATZ	34 21 6 855 474	s. Abb.



					<b>Bezeichnung</b>	<b>OE-Nummern zu ATE Artikelnummern</b>	 z.B. Vorsachnummern / diverse
--	--	--	--	--	--------------------	---	--------------------------------------

## BMW

2er Reihe/F23 Cabrio (14-)	218 i	3) Coupl	03.2015	24.0130-0233.2	430233	2-PIECE BRAKE DISC	34 11 6 792 223	
		3) Coupl	03.2015	13.0460-4874.2	604874	BELAGSATZ	34 21 6 855 474	s. Abb.
	220 d	3) Coupl	11.2014	24.0130-0233.2	430233	2-PIECE BRAKE DISC	34 11 6 792 223	
		3) Coupl	11.2014	13.0460-4874.2	604874	BELAGSATZ	34 21 6 855 474	s. Abb.
	220 i	3) Coupl	11.2014	24.0130-0233.2	430233	2-PIECE BRAKE DISC	34 11 6 792 223	
		3) Coupl	11.2014	13.0460-4874.2	604874	BELAGSATZ	34 21 6 855 474	s. Abb.
	228 i	3) Coupl	11.2014	24.0130-0233.2	430233	2-PIECE BRAKE DISC	34 11 6 792 223	
		3) Coupl	11.2014	13.0460-4874.2	604874	BELAGSATZ	34 21 6 855 474	s. Abb.
	228 i xDrive	3) Coupl	11.2014	24.0130-0233.2	430233	2-PIECE BRAKE DISC	34 11 6 792 223	
		3) Coupl	11.2014	13.0460-4874.2	604874	BELAGSATZ	34 21 6 855 474	s. Abb.
	M 235 i	3) Coupl	11.2014	24.0130-0233.2	430233	2-PIECE BRAKE DISC	34 11 6 792 223	
		3) Coupl	11.2014	13.0460-4874.2	604874	BELAGSATZ	34 21 6 855 474	s. Abb.
3er Reihe/F30 Limousine (12-)	316 d	3) Coupl	02.2012	24.0130-0233.2	430233	2-PIECE BRAKE DISC	34 11 6 792 223	
		3) Coupl	02.2012	13.0460-3866.2	603866	BELAGSATZ	34 11 6 850 568	s. Abb.
		3) Coupl	02.2012	13.0460-4874.2	604874	BELAGSATZ	34 21 6 855 474	s. Abb.
		VA	02.2012	24.0711-6282.3	360387	RADSENSOR	34 52 6 869 320 , 34 52 6 791 224	
	316 i	3) Coupl	11.2012	24.0130-0233.2	430233	2-PIECE BRAKE DISC	34 11 6 792 223	
		3) Coupl	11.2012	13.0460-3866.2	603866	BELAGSATZ	34 11 6 850 568	s. Abb.
		3) Coupl	11.2012	13.0460-4874.2	604874	BELAGSATZ	34 21 6 855 474	s. Abb.
		VA	11.2012	24.0711-6282.3	360387	RADSENSOR	34 52 6 869 320 , 34 52 6 791 224	



					<b>Bezeichnung</b>	<b>OE-Nummern zu ATE Artikelnummern</b>	 z.B. Vorsachnummern / diverse
--	--	--	--	--	--------------------	---	--------------------------------------

## BMW

3er Reihe/F30 Limousine (12-)	318 d	3) Coull	02.2012		24.0130-0233.2	430233	2-PIECE BRAKE DISC	34 11 6 792 223	
		3) Coull	02.2012		13.0460-3866.2	603866	BELAGSATZ	34 11 6 850 568	s. Abb.
		3) Coull	02.2012		13.0460-4874.2	604874	BELAGSATZ	34 21 6 855 474	s. Abb.
		VA	02.2012		24.0711-6282.3	360387	RADSENSOR	34 52 6 869 320 , 34 52 6 791 224	
	318 d xDrive	3) Coull	05.2013		24.0124-0251.2	424251	2-PIECE BRAKE DISC	34 20 6 797 607	
		3) Coull	05.2013		24.0130-0233.2	430233	2-PIECE BRAKE DISC	34 11 6 792 223	
		3) Coull	05.2013		13.0460-4874.2	604874	BELAGSATZ	34 21 6 855 474	s. Abb.
		3) Coull	05.2013		13.0460-3866.2	603866	BELAGSATZ	34 11 6 850 568	s. Abb.
	320 d	3) Coull	02.2012		24.0130-0233.2	430233	2-PIECE BRAKE DISC	34 11 6 792 223	
		3) Coull	02.2012		13.0460-3866.2	603866	BELAGSATZ	34 11 6 850 568	s. Abb.
		3) Coull	02.2012		13.0460-4874.2	604874	BELAGSATZ	34 21 6 855 474	s. Abb.
		VA	02.2012		24.0711-6282.3	360387	RADSENSOR	34 52 6 869 320 , 34 52 6 791 224	
	320 d xDrive	3) Coull	02.2012		24.0130-0233.2	430233	2-PIECE BRAKE DISC	34 11 6 792 223	
		3) Coull	02.2012		24.0124-0251.2	424251	2-PIECE BRAKE DISC	34 20 6 797 607	
		3) Coull	02.2012		13.0460-4874.2	604874	BELAGSATZ	34 21 6 855 474	s. Abb.
	320 i	3) Coull	02.2012		24.0130-0233.2	430233	2-PIECE BRAKE DISC	34 11 6 792 223	
		3) Coull	02.2012		13.0460-3866.2	603866	BELAGSATZ	34 11 6 850 568	s. Abb.
		3) Coull	02.2012		13.0460-4874.2	604874	BELAGSATZ	34 21 6 855 474	s. Abb.
		VA	02.2012		24.0711-6282.3	360387	RADSENSOR	34 52 6 869 320 , 34 52 6 791 224	



					<b>Bezeichnung</b>	<b>OE-Nummern zu ATE Artikelnummern</b>	<b>z.B. Vorsachnummern / diverse</b>
--	--	--	--	--	--------------------	---	--------------------------------------

## BMW

3er Reihe/F30 Limousine (12-)	320 i ed	3) Coull	11.2012	13.0460-3866.2	603866	BELAGSATZ	34 11 6 850 568	s. Abb.
		VA	11.2012	24.0711-6282.3	360387	RADSENSOR	34 52 6 869 320 , 34 52 6 791 224	
	320 i xDrive	3) Coull	02.2012	24.0130-0233.2	430233	2-PIECE BRAKE DISC	34 11 6 792 223	
		3) Coull	02.2012	24.0124-0251.2	424251	2-PIECE BRAKE DISC	34 20 6 797 607	
		3) Coull	02.2012	13.0460-3866.2	603866	BELAGSATZ	34 11 6 850 568	s. Abb.
		3) Coull	02.2012	13.0460-4874.2	604874	BELAGSATZ	34 21 6 855 474	s. Abb.
	325 d	3) Coull	04.2013	24.0130-0234.2	430234	2-PIECE BRAKE DISC	34 10 6 797 606	
		3) Coull	04.2013	13.0460-4874.2	604874	BELAGSATZ	34 21 6 855 474	s. Abb.
		VA	04.2013	24.0711-6282.3	360387	RADSENSOR	34 52 6 869 320 , 34 52 6 791 224	
	328 i	3) Coull	02.2012	24.0130-0234.2	430234	2-PIECE BRAKE DISC	34 10 6 797 606	
		3) Coull	02.2012	24.0124-0251.2	424251	2-PIECE BRAKE DISC	34 20 6 797 607	
		3) Coull	02.2012	13.0460-4874.2	604874	BELAGSATZ	34 21 6 855 474	s. Abb.
		VA	02.2012	24.0711-6282.3	360387	RADSENSOR	34 52 6 869 320 , 34 52 6 791 224	
	328 i xDrive	3) Coull	02.2012	24.0124-0251.2	424251	2-PIECE BRAKE DISC	34 20 6 797 607	
		3) Coull	02.2012	24.0130-0234.2	430234	2-PIECE BRAKE DISC	34 10 6 797 606	
		3) Coull	02.2012	13.0460-4874.2	604874	BELAGSATZ	34 21 6 855 474	s. Abb.
	330 d	3) Coull	07.2012	24.0124-0251.2	424251	2-PIECE BRAKE DISC	34 20 6 797 607	
		3) Coull	07.2012	24.0130-0234.2	430234	2-PIECE BRAKE DISC	34 10 6 797 606	
		3) Coull	07.2012	13.0460-4874.2	604874	BELAGSATZ	34 21 6 855 474	s. Abb.



					<b>Bezeichnung</b>	<b>OE-Nummern zu ATE Artikelnummern</b>	 z.B. Vorsachnummern / diverse
--	--	--	--	--	--------------------	---	-----------------------------------

## BMW

3er Reihe/F30 Limousine (12-)	330 d	VA	07.2012		24.0711-6282.3	360387	RADSENSOR	34 52 6 869 320 , 34 52 6 791 224	
	330 d xDrive	3) Coull	03.2013		24.0130-0234.2	430234	2-PIECE BRAKE DISC	34 10 6 797 606	
		3) Coull	03.2013		24.0124-0251.2	424251	2-PIECE BRAKE DISC	34 20 6 797 607	
		3) Coull	03.2013		13.0460-4874.2	604874	BELAGSATZ	34 21 6 855 474	s. Abb.
	335 d xDrive	3) Coull	07.2013		24.0130-0233.2	430233	2-PIECE BRAKE DISC	34 11 6 792 223	
		3) Coull	07.2013		24.0124-0251.2	424251	2-PIECE BRAKE DISC	34 20 6 797 607	
		3) Coull	07.2013		24.0130-0234.2	430234	2-PIECE BRAKE DISC	34 10 6 797 606	
		3) Coull	07.2013		13.0460-4874.2	604874	BELAGSATZ	34 21 6 855 474	s. Abb.
	335 i	3) Coull	07.2013		24.0130-0233.2	430233	2-PIECE BRAKE DISC	34 11 6 792 223	
		3) Coull	07.2013		24.0124-0251.2	424251	2-PIECE BRAKE DISC	34 20 6 797 607	
		3) Coull	02.2012		24.0124-0251.2	424251	2-PIECE BRAKE DISC	34 20 6 797 607	
		3) Coull	02.2012		24.0130-0233.2	430233	2-PIECE BRAKE DISC	34 11 6 792 223	
		3) Coull	07.2013		24.0130-0234.2	430234	2-PIECE BRAKE DISC	34 10 6 797 606	
		3) Coull	02.2012		24.0130-0234.2	430234	2-PIECE BRAKE DISC	34 10 6 797 606	
		3) Coull	07.2013		13.0460-4874.2	604874	BELAGSATZ	34 21 6 855 474	s. Abb.
		3) Coull	02.2012		13.0460-4874.2	604874	BELAGSATZ	34 21 6 855 474	s. Abb.
		VA	02.2012		24.0711-6282.3	360387	RADSENSOR	34 52 6 869 320 , 34 52 6 791 224	
		VA	07.2013		24.0711-6282.3	360387	RADSENSOR	34 52 6 869 320 , 34 52 6 791 224	
	335 i xDrive	3) Coull	02.2012		24.0130-0234.2	430234	2-PIECE BRAKE DISC	34 10 6 797 606	



					<b>Bezeichnung</b>	<b>OE-Nummern zu ATE Artikelnummern</b>	 z.B. Vorsachnummern / diverse
--	--	--	--	--	--------------------	---	--------------------------------------

## BMW

3er Reihe/F30 Limousine (12-)	335 i xDrive	3) Coull	02.2012		24.0124-0251.2	424251	2-PIECE BRAKE DISC	34 20 6 797 607	
		3) Coull	02.2012		24.0130-0233.2	430233	2-PIECE BRAKE DISC	34 11 6 792 223	
		3) Coull	02.2012		13.0460-4874.2	604874	BELAGSATZ	34 21 6 855 474	s. Abb.
	ActiveHybrid 3	3) Coull	07.2012		24.0130-0233.2	430233	2-PIECE BRAKE DISC	34 11 6 792 223	
		3) Coull	07.2012		24.0130-0234.2	430234	2-PIECE BRAKE DISC	34 10 6 797 606	
		3) Coull	07.2012		24.0124-0251.2	424251	2-PIECE BRAKE DISC	34 20 6 797 607	
		3) Coull	07.2012		13.0460-4874.2	604874	BELAGSATZ	34 21 6 855 474	s. Abb.
		VA	07.2012		24.0711-6282.3	360387	RADSENSOR	34 52 6 869 320 , 34 52 6 791 224	
	M3	VA	01.2014		24.0711-6282.3	360387	RADSENSOR	34 52 6 869 320 , 34 52 6 791 224	
3er Reihe/F31 Touring (12-)	316 d	3) Coull	05.2012		24.0130-0233.2	430233	2-PIECE BRAKE DISC	34 11 6 792 223	
		3) Coull	05.2012		13.0460-3866.2	603866	BELAGSATZ	34 11 6 850 568	s. Abb.
		3) Coull	05.2012		13.0460-4874.2	604874	BELAGSATZ	34 21 6 855 474	s. Abb.
		VA	05.2012		24.0711-6282.3	360387	RADSENSOR	34 52 6 869 320 , 34 52 6 791 224	
	316 i	3) Coull	03.2013		24.0130-0233.2	430233	2-PIECE BRAKE DISC	34 11 6 792 223	
		3) Coull	03.2013		13.0460-3866.2	603866	BELAGSATZ	34 11 6 850 568	s. Abb.
		3) Coull	03.2013		13.0460-4874.2	604874	BELAGSATZ	34 21 6 855 474	s. Abb.
		VA	03.2013		24.0711-6282.3	360387	RADSENSOR	34 52 6 869 320 , 34 52 6 791 224	
	318 d	3) Coull	05.2012		24.0130-0233.2	430233	2-PIECE BRAKE DISC	34 11 6 792 223	
		3) Coull	05.2012		13.0460-3866.2	603866	BELAGSATZ	34 11 6 850 568	s. Abb.



					<b>Bezeichnung</b>	<b>OE-Nummern zu ATE Artikelnummern</b>	 z.B. Vorsachnummern / diverse
--	--	--	--	--	--------------------	---	-----------------------------------

## BMW

3er Reihe/F31 Touring (12-)	318 d	3) Cour	05.2012		13.0460-4874.2	604874	BELAGSATZ	34 21 6 855 474	s. Abb.
		VA	05.2012		24.0711-6282.3	360387	RADSENSOR	34 52 6 869 320 , 34 52 6 791 224	
	318 d xDrive	3) Cour	05.2013		24.0124-0251.2	424251	2-PIECE BRAKE DISC	34 20 6 797 607	
		3) Cour	05.2013		24.0130-0233.2	430233	2-PIECE BRAKE DISC	34 11 6 792 223	
		3) Cour	05.2013		13.0460-4874.2	604874	BELAGSATZ	34 21 6 855 474	s. Abb.
		3) Cour	05.2013		13.0460-3866.2	603866	BELAGSATZ	34 11 6 850 568	s. Abb.
	320 d	3) Cour	05.2012		24.0130-0233.2	430233	2-PIECE BRAKE DISC	34 11 6 792 223	
		3) Cour	05.2012		24.0124-0251.2	424251	2-PIECE BRAKE DISC	34 20 6 797 607	
		3) Cour	05.2012		13.0460-3866.2	603866	BELAGSATZ	34 11 6 850 568	s. Abb.
		3) Cour	05.2012		13.0460-4874.2	604874	BELAGSATZ	34 21 6 855 474	s. Abb.
		VA	05.2012		24.0711-6282.3	360387	RADSENSOR	34 52 6 869 320 , 34 52 6 791 224	
	320 d xDrive	3) Cour	03.2013		24.0124-0251.2	424251	2-PIECE BRAKE DISC	34 20 6 797 607	
		3) Cour	03.2013		24.0130-0233.2	430233	2-PIECE BRAKE DISC	34 11 6 792 223	
		3) Cour	03.2013		13.0460-4874.2	604874	BELAGSATZ	34 21 6 855 474	s. Abb.
	320 i	3) Cour	05.2012		24.0130-0233.2	430233	2-PIECE BRAKE DISC	34 11 6 792 223	
		3) Cour	05.2012		13.0460-4874.2	604874	BELAGSATZ	34 21 6 855 474	s. Abb.
		3) Cour	05.2012		13.0460-3866.2	603866	BELAGSATZ	34 11 6 850 568	s. Abb.
		VA	05.2012		24.0711-6282.3	360387	RADSENSOR	34 52 6 869 320 , 34 52 6 791 224	
	320 i xDrive	3) Cour	03.2013		24.0130-0233.2	430233	2-PIECE BRAKE DISC	34 11 6 792 223	





					<b>Bezeichnung</b>	<b>OE-Nummern zu ATE Artikelnummern</b>	 z.B. Vorsachnummern / diverse
--	--	--	--	--	--------------------	---	--------------------------------------

## BMW

3er Reihe/F31 Touring (12-)	320 i xDrive	3) Cou	03.2013		24.0124-0251.2	424251	2-PIECE BRAKE DISC	34 20 6 797 607	
		3) Cou	03.2013		13.0460-3866.2	603866	BELAGSATZ	34 11 6 850 568	s. Abb.
		3) Cou	03.2013		13.0460-4874.2	604874	BELAGSATZ	34 21 6 855 474	s. Abb.
	325 d	3) Cou	04.2013		24.0130-0233.2	430233	2-PIECE BRAKE DISC	34 11 6 792 223	
		3) Cou	04.2013		24.0130-0234.2	430234	2-PIECE BRAKE DISC	34 10 6 797 606	
		3) Cou	04.2013		13.0460-4874.2	604874	BELAGSATZ	34 21 6 855 474	s. Abb.
		VA	04.2013		24.0711-6282.3	360387	RADSENSOR	34 52 6 869 320 , 34 52 6 791 224	
	328 i	3) Cou	05.2012		24.0124-0251.2	424251	2-PIECE BRAKE DISC	34 20 6 797 607	
		3) Cou	05.2012		24.0130-0234.2	430234	2-PIECE BRAKE DISC	34 10 6 797 606	
		3) Cou	05.2012		24.0130-0233.2	430233	2-PIECE BRAKE DISC	34 11 6 792 223	
		3) Cou	05.2012		13.0460-4874.2	604874	BELAGSATZ	34 21 6 855 474	s. Abb.
		VA	05.2012		24.0711-6282.3	360387	RADSENSOR	34 52 6 869 320 , 34 52 6 791 224	
	328 i xDrive	3) Cou	03.2013		24.0130-0233.2	430233	2-PIECE BRAKE DISC	34 11 6 792 223	
		3) Cou	03.2013		24.0130-0234.2	430234	2-PIECE BRAKE DISC	34 10 6 797 606	
		3) Cou	03.2013		24.0124-0251.2	424251	2-PIECE BRAKE DISC	34 20 6 797 607	
		3) Cou	03.2013		13.0460-4874.2	604874	BELAGSATZ	34 21 6 855 474	s. Abb.
	330 d	3) Cou	05.2012		24.0124-0251.2	424251	2-PIECE BRAKE DISC	34 20 6 797 607	
		3) Cou	05.2012		24.0130-0234.2	430234	2-PIECE BRAKE DISC	34 10 6 797 606	
		3) Cou	05.2012		24.0130-0233.2	430233	2-PIECE BRAKE DISC	34 11 6 792 223	
		3) Cou	05.2012		13.0460-4874.2	604874	BELAGSATZ	34 21 6 855 474	s. Abb.



					<b>Bezeichnung</b>	<b>OE-Nummern zu ATE Artikelnummern</b>	 z.B. Vorsachnummern / diverse
--	--	--	--	--	--------------------	---	-----------------------------------

## BMW

3er Reihe/F31 Touring (12-)	330 d	VA	05.2012		24.0711-6282.3	360387	RADSENSOR	34 52 6 869 320 , 34 52 6 791 224	
	330 d xDrive	3) Coull	03.2013		24.0130-0233.2	430233	2-PIECE BRAKE DISC	34 11 6 792 223	
		3) Coull	03.2013		24.0130-0234.2	430234	2-PIECE BRAKE DISC	34 10 6 797 606	
		3) Coull	03.2013		24.0124-0251.2	424251	2-PIECE BRAKE DISC	34 20 6 797 607	
		3) Coull	03.2013		13.0460-4874.2	604874	BELAGSATZ	34 21 6 855 474	s. Abb.
	335 d xDrive	3) Coull	11.2013		24.0124-0251.2	424251	2-PIECE BRAKE DISC	34 20 6 797 607	
		3) Coull	11.2013		24.0130-0234.2	430234	2-PIECE BRAKE DISC	34 10 6 797 606	
		3) Coull	11.2013		24.0130-0233.2	430233	2-PIECE BRAKE DISC	34 11 6 792 223	
		3) Coull	11.2013		13.0460-4874.2	604874	BELAGSATZ	34 21 6 855 474	s. Abb.
	335 i	3) Coull	03.2013		24.0124-0251.2	424251	2-PIECE BRAKE DISC	34 20 6 797 607	
		3) Coull	05.2012		24.0130-0234.2	430234	2-PIECE BRAKE DISC	34 10 6 797 606	
		3) Coull	03.2013		24.0130-0233.2	430233	2-PIECE BRAKE DISC	34 11 6 792 223	
		3) Coull	03.2013		13.0460-4874.2	604874	BELAGSATZ	34 21 6 855 474	s. Abb.
		VA	03.2013		24.0711-6282.3	360387	RADSENSOR	34 52 6 869 320 , 34 52 6 791 224	
	335 i xDrive	3) Coull	03.2013		24.0130-0233.2	430233	2-PIECE BRAKE DISC	34 11 6 792 223	
		3) Coull	03.2013		24.0124-0251.2	424251	2-PIECE BRAKE DISC	34 20 6 797 607	
		3) Coull	03.2013		24.0130-0234.2	430234	2-PIECE BRAKE DISC	34 10 6 797 606	
		3) Coull	03.2013		13.0460-4874.2	604874	BELAGSATZ	34 21 6 855 474	s. Abb.
3er Reihe/F34 GT (13-)	318 d	3) Coull	03.2013		24.0124-0251.2	424251	2-PIECE BRAKE DISC	34 20 6 797 607	
		3) Coull	03.2013		24.0130-0233.2	430233	2-PIECE BRAKE DISC	34 11 6 792 223	



					<b>Bezeichnung</b>	<b>OE-Nummern zu ATE Artikelnummern</b>	 z.B. Vorsachnummern / diverse
--	--	--	--	--	--------------------	---	--------------------------------------

## BMW

3er Reihe/F34 GT (13-)	318 d	3) Coull	03.2013		13.0460-3866.2	603866	BELAGSATZ	34 11 6 850 568	s. Abb.
		3) Coull	03.2013		13.0460-4874.2	604874	BELAGSATZ	34 21 6 855 474	s. Abb.
	320 d	3) Coull	03.2013		24.0130-0233.2	430233	2-PIECE BRAKE DISC	34 11 6 792 223	
		3) Coull	03.2013		24.0124-0251.2	424251	2-PIECE BRAKE DISC	34 20 6 797 607	
		3) Coull	03.2013		13.0460-4874.2	604874	BELAGSATZ	34 21 6 855 474	s. Abb.
	320 d xDrive	3) Coull	03.2013		24.0130-0233.2	430233	2-PIECE BRAKE DISC	34 11 6 792 223	
		3) Coull	03.2013		24.0124-0251.2	424251	2-PIECE BRAKE DISC	34 20 6 797 607	
		3) Coull	03.2013		13.0460-4874.2	604874	BELAGSATZ	34 21 6 855 474	s. Abb.
	320 i	3) Coull	03.2013		24.0130-0233.2	430233	2-PIECE BRAKE DISC	34 11 6 792 223	
		3) Coull	03.2013		24.0124-0251.2	424251	2-PIECE BRAKE DISC	34 20 6 797 607	
		3) Coull	03.2013		13.0460-4874.2	604874	BELAGSATZ	34 21 6 855 474	s. Abb.
		3) Coull	03.2013		13.0460-3866.2	603866	BELAGSATZ	34 11 6 850 568	s. Abb.
	320 i xDrive	3) Coull	03.2013		24.0130-0233.2	430233	2-PIECE BRAKE DISC	34 11 6 792 223	
		3) Coull	03.2013		24.0124-0251.2	424251	2-PIECE BRAKE DISC	34 20 6 797 607	
		3) Coull	03.2013		13.0460-4874.2	604874	BELAGSATZ	34 21 6 855 474	s. Abb.
		3) Coull	03.2013		13.0460-3866.2	603866	BELAGSATZ	34 11 6 850 568	s. Abb.
	325 d	3) Coull	03.2013		24.0130-0234.2	430234	2-PIECE BRAKE DISC	34 10 6 797 606	
		3) Coull	03.2013		13.0460-4874.2	604874	BELAGSATZ	34 21 6 855 474	s. Abb.
	328 i	3) Coull	03.2013		24.0124-0251.2	424251	2-PIECE BRAKE DISC	34 20 6 797 607	
		3) Coull	03.2013		24.0130-0234.2	430234	2-PIECE BRAKE DISC	34 10 6 797 606	
		3) Coull	03.2013		13.0460-4874.2	604874	BELAGSATZ	34 21 6 855 474	s. Abb.



					<b>Bezeichnung</b>	<b>OE-Nummern zu ATE Artikelnummern</b>	 z.B. Vorsachnummern / diverse
--	--	--	--	--	--------------------	---	--------------------------------------

## BMW

3er Reihe/F34 GT (13-)	328 i xDrive	3) Coup	03.2013		24.0130-0234.2	430234	2-PIECE BRAKE DISC	34 10 6 797 606	
		3) Coup	03.2013		24.0124-0251.2	424251	2-PIECE BRAKE DISC	34 20 6 797 607	
		3) Coup	03.2013		13.0460-4874.2	604874	BELAGSATZ	34 21 6 855 474	s. Abb.
	330 d	3) Coup	03.2014		24.0130-0234.2	430234	2-PIECE BRAKE DISC	34 10 6 797 606	
		3) Coup	03.2014		24.0124-0251.2	424251	2-PIECE BRAKE DISC	34 20 6 797 607	
		3) Coup	03.2014		13.0460-4874.2	604874	BELAGSATZ	34 21 6 855 474	s. Abb.
	330 d xDrive	3) Coup	03.2014		24.0124-0251.2	424251	2-PIECE BRAKE DISC	34 20 6 797 607	
		3) Coup	03.2014		24.0130-0234.2	430234	2-PIECE BRAKE DISC	34 10 6 797 606	
		3) Coup	03.2014		13.0460-4874.2	604874	BELAGSATZ	34 21 6 855 474	s. Abb.
	335 d xDrive	3) Coup	03.2014		24.0124-0251.2	424251	2-PIECE BRAKE DISC	34 20 6 797 607	
		3) Coup	03.2014		24.0130-0234.2	430234	2-PIECE BRAKE DISC	34 10 6 797 606	
		3) Coup	03.2014		13.0460-4874.2	604874	BELAGSATZ	34 21 6 855 474	s. Abb.
	335 i	3) Coup	03.2013		24.0124-0251.2	424251	2-PIECE BRAKE DISC	34 20 6 797 607	
		3) Coup	03.2013		24.0130-0233.2	430233	2-PIECE BRAKE DISC	34 11 6 792 223	
		3) Coup	03.2013		24.0130-0234.2	430234	2-PIECE BRAKE DISC	34 10 6 797 606	
		3) Coup	03.2013		13.0460-4874.2	604874	BELAGSATZ	34 21 6 855 474	s. Abb.
	335 i xDrive	3) Coup	03.2013		24.0130-0234.2	430234	2-PIECE BRAKE DISC	34 10 6 797 606	
		3) Coup	03.2013		24.0124-0251.2	424251	2-PIECE BRAKE DISC	34 20 6 797 607	
		3) Coup	03.2013		24.0130-0233.2	430233	2-PIECE BRAKE DISC	34 11 6 792 223	
		3) Coup	03.2013		13.0460-4874.2	604874	BELAGSATZ	34 21 6 855 474	s. Abb.
4er Reihe/F32 Coupe (13-)	418 d	3) Coup	03.2015		24.0130-0233.2	430233	2-PIECE BRAKE DISC	34 11 6 792 223	



					<b>Bezeichnung</b>	<b>OE-Nummern zu ATE Artikelnummern</b>	<b>i</b> z.B. Vorsachnummern / diverse
--	--	--	--	--	--------------------	---	---

## BMW

4er Reihe/F32 Coupe (13-)	418 d	3) Cou	03.2015		13.0460-3866.2	603866	BELAGSATZ	34 11 6 850 568	s. Abb.
		3) Cou	03.2015		13.0460-4874.2	604874	BELAGSATZ	34 21 6 855 474	s. Abb.
		VA	03.2015		24.0711-6282.3	360387	RADSENSOR	34 52 6 869 320 , 34 52 6 791 224	
	420 d	3) Cou	07.2013		24.0130-0233.2	430233	2-PIECE BRAKE DISC	34 11 6 792 223	
		3) Cou	03.2015		24.0130-0233.2	430233	2-PIECE BRAKE DISC	34 11 6 792 223	
		3) Cou	03.2015		13.0460-4874.2	604874	BELAGSATZ	34 21 6 855 474	s. Abb.
		3) Cou	07.2013		13.0460-4874.2	604874	BELAGSATZ	34 21 6 855 474	s. Abb.
		VA	07.2013		24.0711-6282.3	360387	RADSENSOR	34 52 6 869 320 , 34 52 6 791 224	
		VA	03.2015		24.0711-6282.3	360387	RADSENSOR	34 52 6 869 320 , 34 52 6 791 224	
	420 d xDrive	3) Cou	03.2015		24.0124-0251.2	424251	2-PIECE BRAKE DISC	34 20 6 797 607	
		3) Cou	03.2015		24.0130-0233.2	430233	2-PIECE BRAKE DISC	34 11 6 792 223	
		3) Cou	07.2013		24.0130-0233.2	430233	2-PIECE BRAKE DISC	34 11 6 792 223	
		3) Cou	07.2013		24.0124-0251.2	424251	2-PIECE BRAKE DISC	34 20 6 797 607	
		3) Cou	07.2013		13.0460-4874.2	604874	BELAGSATZ	34 21 6 855 474	s. Abb.
		3) Cou	03.2015		13.0460-4874.2	604874	BELAGSATZ	34 21 6 855 474	s. Abb.
	420 i	3) Cou	07.2013		24.0130-0233.2	430233	2-PIECE BRAKE DISC	34 11 6 792 223	
		3) Cou	07.2013		13.0460-3866.2	603866	BELAGSATZ	34 11 6 850 568	s. Abb.
		3) Cou	07.2013		13.0460-4874.2	604874	BELAGSATZ	34 21 6 855 474	s. Abb.
		VA	07.2013		24.0711-6282.3	360387	RADSENSOR	34 52 6 869 320 , 34 52 6 791 224	



					<b>Bezeichnung</b>	<b>OE-Nummern zu ATE Artikelnummern</b>	 z.B. Vorsachnummern / diverse
--	--	--	--	--	--------------------	---	--------------------------------------

## BMW

4er Reihe/F32 Coupe (13-)	420 i xDrive	3) Cou	07.2013		24.0130-0233.2	430233	2-PIECE BRAKE DISC	34 11 6 792 223	
		3) Cou	07.2013		24.0124-0251.2	424251	2-PIECE BRAKE DISC	34 20 6 797 607	
		3) Cou	07.2013		13.0460-3866.2	603866	BELAGSATZ	34 11 6 850 568	s. Abb.
		3) Cou	07.2013		13.0460-4874.2	604874	BELAGSATZ	34 21 6 855 474	s. Abb.
	425 d	3) Cou	03.2014		24.0130-0234.2	430234	2-PIECE BRAKE DISC	34 10 6 797 606	
		3) Cou	03.2014		13.0460-4874.2	604874	BELAGSATZ	34 21 6 855 474	s. Abb.
		VA	03.2014		24.0711-6282.3	360387	RADSENSOR	34 52 6 869 320 , 34 52 6 791 224	
	428 i	3) Cou	07.2013		24.0130-0234.2	430234	2-PIECE BRAKE DISC	34 10 6 797 606	
		3) Cou	07.2013		24.0124-0251.2	424251	2-PIECE BRAKE DISC	34 20 6 797 607	
		3) Cou	07.2013		13.0460-4874.2	604874	BELAGSATZ	34 21 6 855 474	s. Abb.
		VA	07.2013		24.0711-6282.3	360387	RADSENSOR	34 52 6 869 320 , 34 52 6 791 224	
	428 i xDrive	3) Cou	07.2013		24.0130-0234.2	430234	2-PIECE BRAKE DISC	34 10 6 797 606	
		3) Cou	07.2013		24.0124-0251.2	424251	2-PIECE BRAKE DISC	34 20 6 797 607	
		3) Cou	07.2013		13.0460-4874.2	604874	BELAGSATZ	34 21 6 855 474	s. Abb.
	430 d	3) Cou	07.2013		24.0130-0234.2	430234	2-PIECE BRAKE DISC	34 10 6 797 606	
		3) Cou	07.2013		24.0124-0251.2	424251	2-PIECE BRAKE DISC	34 20 6 797 607	
		3) Cou	07.2013		13.0460-4874.2	604874	BELAGSATZ	34 21 6 855 474	s. Abb.
		VA	07.2013		24.0711-6282.3	360387	RADSENSOR	34 52 6 869 320 , 34 52 6 791 224	
	430 d xDrive	3) Cou	03.2014		24.0130-0234.2	430234	2-PIECE BRAKE DISC	34 10 6 797 606	



					<b>Bezeichnung</b>	<b>OE-Nummern zu ATE Artikelnummern</b>	 z.B. Vorsachnummern / diverse
--	--	--	--	--	--------------------	---	-----------------------------------

## BMW

4er Reihe/F32 Coupe (13-)	430 d xDrive	3) Cou	03.2014		24.0124-0251.2	424251	2-PIECE BRAKE DISC	34 20 6 797 607	
		3) Cou	03.2014		13.0460-4874.2	604874	BELAGSATZ	34 21 6 855 474	s. Abb.
	435 d xDrive	3) Cou	07.2013		24.0130-0234.2	430234	2-PIECE BRAKE DISC	34 10 6 797 606	
		3) Cou	07.2013		24.0124-0251.2	424251	2-PIECE BRAKE DISC	34 20 6 797 607	
		3) Cou	07.2013		24.0130-0233.2	430233	2-PIECE BRAKE DISC	34 11 6 792 223	
		3) Cou	07.2013		13.0460-4874.2	604874	BELAGSATZ	34 21 6 855 474	s. Abb.
	435 i	3) Cou	07.2013		24.0130-0234.2	430234	2-PIECE BRAKE DISC	34 10 6 797 606	
		3) Cou	07.2013		24.0130-0233.2	430233	2-PIECE BRAKE DISC	34 11 6 792 223	
		3) Cou	07.2013		24.0124-0251.2	424251	2-PIECE BRAKE DISC	34 20 6 797 607	
		3) Cou	07.2013		13.0460-4874.2	604874	BELAGSATZ	34 21 6 855 474	s. Abb.
		VA	07.2013		24.0711-6282.3	360387	RADSENSOR	34 52 6 869 320 , 34 52 6 791 224	
	435 i xDrive	3) Cou	07.2013		24.0124-0251.2	424251	2-PIECE BRAKE DISC	34 20 6 797 607	
		3) Cou	07.2013		24.0130-0234.2	430234	2-PIECE BRAKE DISC	34 10 6 797 606	
		3) Cou	07.2013		24.0130-0233.2	430233	2-PIECE BRAKE DISC	34 11 6 792 223	
		3) Cou	07.2013		13.0460-4874.2	604874	BELAGSATZ	34 21 6 855 474	s. Abb.
	M4	VA	03.2014		24.0711-6282.3	360387	RADSENSOR	34 52 6 869 320 , 34 52 6 791 224	
4er Reihe/F33 Cabrio (14-)	420 d	3) Cou	10.2013		24.0130-0233.2	430233	2-PIECE BRAKE DISC	34 11 6 792 223	
		3) Cou	10.2013		24.0124-0251.2	424251	2-PIECE BRAKE DISC	34 20 6 797 607	
		3) Cou	10.2013		13.0460-4874.2	604874	BELAGSATZ	34 21 6 855 474	s. Abb.





	<b>i</b>			<b>Bezeichnung</b>	<b>OE-Nummern zu ATE Artikelnummern</b>	<b>i</b> z.B. Vorsachnummern / diverse
--	----------	--	--	--------------------	---	--

## BMW

4er Reihe/F33 Cabrio (14-)	420 d	VA	10.2013		24.0711-6282.3	360387	RADSENSOR	34 52 6 869 320 , 34 52 6 791 224	
	420 i	3) Coull	07.2014		24.0130-0233.2	430233	2-PIECE BRAKE DISC	34 11 6 792 223	
		3) Coull	07.2014		24.0124-0251.2	424251	2-PIECE BRAKE DISC	34 20 6 797 607	
		3) Coull	07.2014		13.0460-4874.2	604874	BELAGSATZ	34 21 6 855 474	s. Abb.
		3) Coull	07.2014		13.0460-3866.2	603866	BELAGSATZ	34 11 6 850 568	s. Abb.
		VA	07.2014		24.0711-6282.3	360387	RADSENSOR	34 52 6 869 320 , 34 52 6 791 224	
	425 d	3) Coull	07.2014		24.0130-0234.2	430234	2-PIECE BRAKE DISC	34 10 6 797 606	
		3) Coull	07.2014		24.0124-0251.2	424251	2-PIECE BRAKE DISC	34 20 6 797 607	
		3) Coull	07.2014		13.0460-4874.2	604874	BELAGSATZ	34 21 6 855 474	s. Abb.
		VA	07.2014		24.0711-6282.3	360387	RADSENSOR	34 52 6 869 320 , 34 52 6 791 224	
	428 i	3) Coull	10.2013		24.0124-0251.2	424251	2-PIECE BRAKE DISC	34 20 6 797 607	
		3) Coull	10.2013		24.0130-0234.2	430234	2-PIECE BRAKE DISC	34 10 6 797 606	
		3) Coull	10.2013		13.0460-4874.2	604874	BELAGSATZ	34 21 6 855 474	s. Abb.
		VA	10.2013		24.0711-6282.3	360387	RADSENSOR	34 52 6 869 320 , 34 52 6 791 224	
	428 i xDrive	3) Coull	10.2013		24.0130-0234.2	430234	2-PIECE BRAKE DISC	34 10 6 797 606	
		3) Coull	10.2013		24.0124-0251.2	424251	2-PIECE BRAKE DISC	34 20 6 797 607	
		3) Coull	10.2013		13.0460-4874.2	604874	BELAGSATZ	34 21 6 855 474	s. Abb.
	430 d	3) Coull	07.2014		24.0130-0234.2	430234	2-PIECE BRAKE DISC	34 10 6 797 606	
		3) Coull	07.2014		24.0124-0251.2	424251	2-PIECE BRAKE DISC	34 20 6 797 607	



					<b>Bezeichnung</b>	<b>OE-Nummern zu ATE Artikelnummern</b>	 z.B. Vorsachnummern / diverse
--	--	--	--	--	--------------------	---	-----------------------------------

## BMW

4er Reihe/F33 Cabrio (14-)	430 d	3) Coupl	07.2014		13.0460-4874.2	604874	BELAGSATZ	34 21 6 855 474	s. Abb.
		VA	07.2014		24.0711-6282.3	360387	RADSENSOR	34 52 6 869 320 , 34 52 6 791 224	
	435 d xDrive	3) Coupl	07.2014		24.0130-0234.2	430234	2-PIECE BRAKE DISC	34 10 6 797 606	
		3) Coupl	07.2014		24.0130-0233.2	430233	2-PIECE BRAKE DISC	34 11 6 792 223	
		3) Coupl	07.2014		24.0124-0251.2	424251	2-PIECE BRAKE DISC	34 20 6 797 607	
		3) Coupl	07.2014		13.0460-4874.2	604874	BELAGSATZ	34 21 6 855 474	s. Abb.
	435 i	3) Coupl	10.2013		24.0130-0234.2	430234	2-PIECE BRAKE DISC	34 10 6 797 606	
		3) Coupl	10.2013		24.0130-0233.2	430233	2-PIECE BRAKE DISC	34 11 6 792 223	
		3) Coupl	10.2013		24.0124-0251.2	424251	2-PIECE BRAKE DISC	34 20 6 797 607	
		3) Coupl	10.2013		13.0460-4874.2	604874	BELAGSATZ	34 21 6 855 474	s. Abb.
		VA	10.2013		24.0711-6282.3	360387	RADSENSOR	34 52 6 869 320 , 34 52 6 791 224	
	435 i xDrive	3) Coupl	10.2013		24.0130-0233.2	430233	2-PIECE BRAKE DISC	34 11 6 792 223	
		3) Coupl	10.2013		24.0130-0234.2	430234	2-PIECE BRAKE DISC	34 10 6 797 606	
		3) Coupl	10.2013		24.0124-0251.2	424251	2-PIECE BRAKE DISC	34 20 6 797 607	
		3) Coupl	10.2013		13.0460-4874.2	604874	BELAGSATZ	34 21 6 855 474	s. Abb.
	M4	VA	07.2014		24.0711-6282.3	360387	RADSENSOR	34 52 6 869 320 , 34 52 6 791 224	
4er Reihe/F36 Gran Coupe (14-)	418 d	3) Coupl	03.2014		24.0130-0233.2	430233	2-PIECE BRAKE DISC	34 11 6 792 223	
		3) Coupl	03.2014		13.0460-4874.2	604874	BELAGSATZ	34 21 6 855 474	s. Abb.
		3) Coupl	03.2014		13.0460-3866.2	603866	BELAGSATZ	34 11 6 850 568	s. Abb.



					<b>Bezeichnung</b>	<b>OE-Nummern zu ATE Artikelnummern</b>	<b>i</b> z.B. Vorsachnummern / diverse
--	--	--	--	--	--------------------	---	---

## BMW

4er Reihe/F36 Gran Coupe (14-)	418 d	VA	03.2014		24.0711-6282.3	360387	RADSENSOR	34 52 6 869 320 , 34 52 6 791 224	
	420 d	3) Coup	03.2015		24.0130-0233.2	430233	2-PIECE BRAKE DISC	34 11 6 792 223	
		3) Coup	03.2014		24.0130-0233.2	430233	2-PIECE BRAKE DISC	34 11 6 792 223	
		3) Coup	03.2015		24.0124-0251.2	424251	2-PIECE BRAKE DISC	34 20 6 797 607	
		3) Coup	03.2015		13.0460-4874.2	604874	BELAGSATZ	34 21 6 855 474	s. Abb.
		3) Coup	03.2014		13.0460-4874.2	604874	BELAGSATZ	34 21 6 855 474	s. Abb.
		VA	03.2015		24.0711-6282.3	360387	RADSENSOR	34 52 6 869 320 , 34 52 6 791 224	
		VA	03.2014		24.0711-6282.3	360387	RADSENSOR	34 52 6 869 320 , 34 52 6 791 224	
	420 d xDrive	3) Coup	03.2014		24.0130-0233.2	430233	2-PIECE BRAKE DISC	34 11 6 792 223	
		3) Coup	03.2015		24.0130-0233.2	430233	2-PIECE BRAKE DISC	34 11 6 792 223	
		3) Coup	03.2014		24.0124-0251.2	424251	2-PIECE BRAKE DISC	34 20 6 797 607	
		3) Coup	03.2015		24.0124-0251.2	424251	2-PIECE BRAKE DISC	34 20 6 797 607	
		3) Coup	03.2015		13.0460-4874.2	604874	BELAGSATZ	34 21 6 855 474	s. Abb.
		3) Coup	03.2014		13.0460-4874.2	604874	BELAGSATZ	34 21 6 855 474	s. Abb.
	420 i	3) Coup	03.2014		24.0124-0251.2	424251	2-PIECE BRAKE DISC	34 20 6 797 607	
		3) Coup	03.2014		24.0130-0233.2	430233	2-PIECE BRAKE DISC	34 11 6 792 223	
		3) Coup	03.2014		13.0460-4874.2	604874	BELAGSATZ	34 21 6 855 474	s. Abb.
		VA	03.2014		24.0711-6282.3	360387	RADSENSOR	34 52 6 869 320 , 34 52 6 791 224	
	420 i xDrive	3) Coup	07.2014		24.0124-0251.2	424251	2-PIECE BRAKE DISC	34 20 6 797 607	



					<b>Bezeichnung</b>	<b>OE-Nummern zu ATE Artikelnummern</b>	 z.B. Vorsachnummern / diverse
--	--	--	--	--	--------------------	---	--------------------------------------

## BMW

4er Reihe/F36 Gran Coupe (14-)	420 i xDrive	3) Coull	07.2014		24.0130-0233.2	430233	2-PIECE BRAKE DISC	34 11 6 792 223	
		3) Coull	07.2014		13.0460-3866.2	603866	BELAGSATZ	34 11 6 850 568	s. Abb.
		3) Coull	07.2014		13.0460-4874.2	604874	BELAGSATZ	34 21 6 855 474	s. Abb.
	428 i	3) Coull	03.2014		24.0124-0251.2	424251	2-PIECE BRAKE DISC	34 20 6 797 607	
		3) Coull	03.2014		24.0130-0234.2	430234	2-PIECE BRAKE DISC	34 10 6 797 606	
		3) Coull	03.2014		13.0460-4874.2	604874	BELAGSATZ	34 21 6 855 474	s. Abb.
		VA	03.2014		24.0711-6282.3	360387	RADSENSOR	34 52 6 869 320 , 34 52 6 791 224	
	428 i xDrive	3) Coull	03.2014		24.0124-0251.2	424251	2-PIECE BRAKE DISC	34 20 6 797 607	
		3) Coull	03.2014		24.0130-0234.2	430234	2-PIECE BRAKE DISC	34 10 6 797 606	
		3) Coull	03.2014		13.0460-4874.2	604874	BELAGSATZ	34 21 6 855 474	s. Abb.
	430 d	3) Coull	07.2014		24.0130-0234.2	430234	2-PIECE BRAKE DISC	34 10 6 797 606	
		3) Coull	07.2014		24.0124-0251.2	424251	2-PIECE BRAKE DISC	34 20 6 797 607	
		3) Coull	07.2014		13.0460-4874.2	604874	BELAGSATZ	34 21 6 855 474	s. Abb.
	430 d xDrive	3) Coull	07.2014		24.0130-0234.2	430234	2-PIECE BRAKE DISC	34 10 6 797 606	
		3) Coull	07.2014		24.0124-0251.2	424251	2-PIECE BRAKE DISC	34 20 6 797 607	
		3) Coull	07.2014		13.0460-4874.2	604874	BELAGSATZ	34 21 6 855 474	s. Abb.
	435 d xDrive	3) Coull	07.2014		24.0124-0251.2	424251	2-PIECE BRAKE DISC	34 20 6 797 607	
		3) Coull	07.2014		24.0130-0233.2	430233	2-PIECE BRAKE DISC	34 11 6 792 223	
		3) Coull	07.2014		24.0130-0234.2	430234	2-PIECE BRAKE DISC	34 10 6 797 606	
		3) Coull	07.2014		13.0460-4874.2	604874	BELAGSATZ	34 21 6 855 474	s. Abb.



					<b>Bezeichnung</b>	<b>OE-Nummern zu ATE Artikelnummern</b>	 z.B. Vorsachnummern / diverse
--	--	--	--	--	--------------------	---	-----------------------------------

## BMW

4er Reihe/F36 Gran Coupe (14-)	435 i	3) Coull	03.2014		24.0130-0234.2	430234	2-PIECE BRAKE DISC	34 10 6 797 606	
		3) Coull	03.2014		24.0130-0233.2	430233	2-PIECE BRAKE DISC	34 11 6 792 223	
		3) Coull	03.2014		24.0124-0251.2	424251	2-PIECE BRAKE DISC	34 20 6 797 607	
		3) Coull	03.2014		13.0460-4874.2	604874	BELAGSATZ	34 21 6 855 474	s. Abb.
		VA	03.2014		24.0711-6282.3	360387	RADSENSOR	34 52 6 869 320 , 34 52 6 791 224	
	435 i xDrive	3) Coull	07.2014		24.0124-0251.2	424251	2-PIECE BRAKE DISC	34 20 6 797 607	
		3) Coull	07.2014		24.0130-0233.2	430233	2-PIECE BRAKE DISC	34 11 6 792 223	
		3) Coull	07.2014		24.0130-0234.2	430234	2-PIECE BRAKE DISC	34 10 6 797 606	
		3) Coull	07.2014		13.0460-4874.2	604874	BELAGSATZ	34 21 6 855 474	s. Abb.
5er Reihe/E60 Limousine (03-10)	520 d	3) Coull	09.2007	02.2010	13.0460-7296.2	607296	BELAGSATZ	34 11 6 794 916 , 34 11 6 794 918	s. Abb.
		3) Coull	07.2005	02.2010	13.0460-7296.2	607296	BELAGSATZ	34 11 6 794 916 , 34 11 6 794 918	s. Abb.
	520 i	3) Coull	07.2003	03.2005	13.0460-7296.2	607296	BELAGSATZ	34 11 6 794 916 , 34 11 6 794 918	s. Abb.
	523 i	3) Coull	03.2007	02.2010	13.0460-7296.2	607296	BELAGSATZ	34 11 6 794 916 , 34 11 6 794 918	s. Abb.
		3) Coull	07.2005	03.2007	13.0460-7296.2	607296	BELAGSATZ	34 11 6 794 916 , 34 11 6 794 918	s. Abb.
	525 d	3) Coull	03.2007	02.2010	13.0460-7296.2	607296	BELAGSATZ	34 11 6 794 916 , 34 11 6 794 918	s. Abb.
		3) Coull	10.2003	03.2007	13.0460-7296.2	607296	BELAGSATZ	34 11 6 794 916 , 34 11 6 794 918	s. Abb.
	525 i	3) Coull	03.2007	02.2010	13.0460-7296.2	607296	BELAGSATZ	34 11 6 794 916 , 34 11 6 794 918	s. Abb.



					<b>Bezeichnung</b>	<b>OE-Nummern zu ATE Artikelnummern</b>	<b>i</b> z.B. Vorsachnummern / diverse
--	--	--	--	--	--------------------	---	---

## BMW

5er Reihe/E60 Limousine (03-10)	525 i	3) Coull	07.2003	06.2005	13.0460-7296.2	607296	BELAGSATZ	34 11 6 794 916 , 34 11 6 794 918	s. Abb.
		3) Coull	07.2005	03.2007	13.0460-7296.2	607296	BELAGSATZ	34 11 6 794 916 , 34 11 6 794 918	s. Abb.
	525 xd	3) Coull	03.2007	02.2010	13.0460-7296.2	607296	BELAGSATZ	34 11 6 794 916 , 34 11 6 794 918	s. Abb.
	525 xi	3) Coull	07.2005	02.2010	13.0460-7296.2	607296	BELAGSATZ	34 11 6 794 916 , 34 11 6 794 918	s. Abb.
	530 d	3) Coull	03.2007	02.2010	13.0460-7296.2	607296	BELAGSATZ	34 11 6 794 916 , 34 11 6 794 918	s. Abb.
		3) Coull	07.2003	03.2007	13.0460-7296.2	607296	BELAGSATZ	34 11 6 794 916 , 34 11 6 794 918	s. Abb.
		3) Coull	07.2003	08.2005	13.0460-7296.2	607296	BELAGSATZ	34 11 6 794 916 , 34 11 6 794 918	s. Abb.
	530 i	3) Coull	07.2003	03.2005	13.0460-7296.2	607296	BELAGSATZ	34 11 6 794 916 , 34 11 6 794 918	s. Abb.
		3) Coull	07.2005	03.2007	13.0460-7296.2	607296	BELAGSATZ	34 11 6 794 916 , 34 11 6 794 918	s. Abb.
		3) Coull	01.2007	02.2010	13.0460-7296.2	607296	BELAGSATZ	34 11 6 794 916 , 34 11 6 794 918	s. Abb.
	530 xd	3) Coull	07.2005	03.2007	13.0460-7296.2	607296	BELAGSATZ	34 11 6 794 916 , 34 11 6 794 918	s. Abb.
		3) Coull	03.2007	02.2010	13.0460-7296.2	607296	BELAGSATZ	34 11 6 794 916 , 34 11 6 794 918	s. Abb.
	530 xi	3) Coull	03.2007	02.2010	13.0460-7296.2	607296	BELAGSATZ	34 11 6 794 916 , 34 11 6 794 918	s. Abb.
		3) Coull	07.2005	03.2007	13.0460-7296.2	607296	BELAGSATZ	34 11 6 794 916 , 34 11 6 794 918	s. Abb.



					<b>Bezeichnung</b>	<b>OE-Nummern zu ATE Artikelnummern</b>	 z.B. Vorsachnummern / diverse
--	--	--	--	--	--------------------	---	--------------------------------------

## BMW

5er Reihe/E60 Limousine (03-10)	540 i	3) Coull	03.2007	02.2010	13.0460-7296.2	607296	BELAGSATZ	34 11 6 794 916 , 34 11 6 794 918	s. Abb.
		3) Coull	07.2005	03.2007	13.0460-7296.2	607296	BELAGSATZ	34 11 6 794 916 , 34 11 6 794 918	s. Abb.
	545 i	3) Coull	07.2003	08.2005	13.0460-7296.2	607296	BELAGSATZ	34 11 6 794 916 , 34 11 6 794 918	s. Abb.
	550 i	3) Coull	03.2007	02.2010	13.0460-7296.2	607296	BELAGSATZ	34 11 6 794 916 , 34 11 6 794 918	s. Abb.
5er Reihe/E61 Touring (04-10)	520 d	3) Coull	09.2007	05.2010	13.0460-7296.2	607296	BELAGSATZ	34 11 6 794 916 , 34 11 6 794 918	s. Abb.
		3) Coull	09.2005	05.2010	13.0460-7296.2	607296	BELAGSATZ	34 11 6 794 916 , 34 11 6 794 918	s. Abb.
		3) Coull	07.2005	05.2010	13.0460-7296.2	607296	BELAGSATZ	34 11 6 794 916 , 34 11 6 794 918	s. Abb.
	520 i	3) Coull	06.2004	05.2010	13.0460-7296.2	607296	BELAGSATZ	34 11 6 794 916 , 34 11 6 794 918	s. Abb.
	523 i	3) Coull	03.2007	05.2010	13.0460-7296.2	607296	BELAGSATZ	34 11 6 794 916 , 34 11 6 794 918	s. Abb.
		3) Coull	07.2005	03.2007	13.0460-7296.2	607296	BELAGSATZ	34 11 6 794 916 , 34 11 6 794 918	s. Abb.
	525 d	3) Coull	12.2004	05.2010	13.0460-7296.2	607296	BELAGSATZ	34 11 6 794 916 , 34 11 6 794 918	s. Abb.
		3) Coull	05.2004	03.2007	13.0460-7296.2	607296	BELAGSATZ	34 11 6 794 916 , 34 11 6 794 918	s. Abb.
		3) Coull	03.2007	05.2010	13.0460-7296.2	607296	BELAGSATZ	34 11 6 794 916 , 34 11 6 794 918	s. Abb.
	525 i	3) Coull	07.2005	03.2007	13.0460-7296.2	607296	BELAGSATZ	34 11 6 794 916 , 34 11 6 794 918	s. Abb.



					<b>Bezeichnung</b>	<b>OE-Nummern zu ATE Artikelnummern</b>	<b>i</b> z.B. Vorsachnummern / diverse
--	--	--	--	--	--------------------	---	---

## BMW

5er Reihe/E61 Touring (04-10)	525 i	3) Coull	05.2004	03.2005	13.0460-7296.2	607296	BELAGSATZ	34 11 6 794 916 , 34 11 6 794 918	s. Abb.
		3) Coull	03.2007	05.2010	13.0460-7296.2	607296	BELAGSATZ	34 11 6 794 916 , 34 11 6 794 918	s. Abb.
	525 xd	3) Coull	03.2007	05.2010	13.0460-7296.2	607296	BELAGSATZ	34 11 6 794 916 , 34 11 6 794 918	s. Abb.
	525 xi	3) Coull	07.2005	05.2010	13.0460-7296.2	607296	BELAGSATZ	34 11 6 794 916 , 34 11 6 794 918	s. Abb.
	530 d	3) Coull	05.2004	08.2005	13.0460-7296.2	607296	BELAGSATZ	34 11 6 794 916 , 34 11 6 794 918	s. Abb.
		3) Coull	07.2005	05.2010	13.0460-7296.2	607296	BELAGSATZ	34 11 6 794 916 , 34 11 6 794 918	s. Abb.
		3) Coull	03.2007	05.2010	13.0460-7296.2	607296	BELAGSATZ	34 11 6 794 916 , 34 11 6 794 918	s. Abb.
	530 i	3) Coull	07.2005	03.2007	13.0460-7296.2	607296	BELAGSATZ	34 11 6 794 916 , 34 11 6 794 918	s. Abb.
		3) Coull	03.2007	05.2010	13.0460-7296.2	607296	BELAGSATZ	34 11 6 794 916 , 34 11 6 794 918	s. Abb.
	530 xd	3) Coull	07.2005	03.2007	13.0460-7296.2	607296	BELAGSATZ	34 11 6 794 916 , 34 11 6 794 918	s. Abb.
		3) Coull	03.2007	05.2010	13.0460-7296.2	607296	BELAGSATZ	34 11 6 794 916 , 34 11 6 794 918	s. Abb.
	530 xi	3) Coull	03.2007	05.2010	13.0460-7296.2	607296	BELAGSATZ	34 11 6 794 916 , 34 11 6 794 918	s. Abb.
		3) Coull	07.2005	03.2007	13.0460-7296.2	607296	BELAGSATZ	34 11 6 794 916 , 34 11 6 794 918	s. Abb.
	545 i	3) Coull	05.2004	08.2005	13.0460-7296.2	607296	BELAGSATZ	34 11 6 794 916 , 34 11 6 794 918	s. Abb.









					<b>Bezeichnung</b>	<b>OE-Nummern zu ATE Artikelnummern</b>	 z.B. Vorsachnummern / diverse
--	--	--	--	--	--------------------	---	--------------------------------------

## BMW

5er Reihe/E61 Touring (04-10)	550 i	3) Coup	03.2007	05.2010	13.0460-7296.2	607296	BELAGSATZ	34 11 6 794 916 , 34 11 6 794 918	s. Abb.
6er Reihe/E63 Coupe (04-11)	630 i	3) Coup	07.2004	08.2007	13.0460-7296.2	607296	BELAGSATZ	34 11 6 794 916 , 34 11 6 794 918	s. Abb.
		3) Coup	09.2007	05.2011	13.0460-7296.2	607296	BELAGSATZ	34 11 6 794 916 , 34 11 6 794 918	s. Abb.
6er Reihe/E64 Cabrio (04-11)		3) Coup	09.2007	02.2011	13.0460-7296.2	607296	BELAGSATZ	34 11 6 794 916 , 34 11 6 794 918	s. Abb.
		3) Coup	07.2004	08.2007	13.0460-7296.2	607296	BELAGSATZ	34 11 6 794 916 , 34 11 6 794 918	s. Abb.
Z4 Roadster/E89 (09-)	sDrive 18i	3) Coup	03.2013		03.2025-5826.3	010960	TANDEM MASTER CYLINDE	34 33 6 786 755	
	sDrive 20i	3) Coup	09.2011		03.2025-5826.3	010960	TANDEM MASTER CYLINDE	34 33 6 786 755	
	sDrive 23i	3) Coup	01.2009		03.2025-5826.3	010960	TANDEM MASTER CYLINDE	34 33 6 786 755	
	sDrive 28i	3) Coup	09.2011		03.2025-5826.3	010960	TANDEM MASTER CYLINDE	34 33 6 786 755	
	sDrive 30i	3) Coup	01.2009		03.2025-5826.3	010960	TANDEM MASTER CYLINDE	34 33 6 786 755	
	sDrive 35i	3) Coup	01.2009		03.2025-5826.3	010960	TANDEM MASTER CYLINDE	34 33 6 786 755	
	sDrive 35is	3) Coup	09.2010		03.2025-5826.3	010960	TANDEM MASTER CYLINDE	34 33 6 786 755	



					<b>Bezeichnung</b>	<b>OE-Nummern zu ATE Artikelnummern</b>	 <b>z.B. Vorsachnummern / diverse</b>
---	---	---	--	---	--------------------	---	---

## CHEVROLET

SPARK (10-)	1	3) Cou	03.2010		13.0460-5642.2	605642	BELAGSATZ	96682858	s. Abb.
	1,0 16V	3) Cou	03.2010		13.0460-5642.2	605642	BELAGSATZ	96682858	s. Abb.
	1,2 16V	3) Cou	01.2011		13.0460-5642.2	605642	BELAGSATZ	96682858	s. Abb.
		3) Cou	03.2010		13.0460-5642.2	605642	BELAGSATZ	96682858	s. Abb.
	1,2 LPG	3) Cou	03.2010		13.0460-5642.2	605642	BELAGSATZ	96682858	s. Abb.
		3) Cou	01.2011		13.0460-5642.2	605642	BELAGSATZ	96682858	s. Abb.



					<b>Bezeichnung</b>	<b>OE-Nummern zu ATE Artikelnummern</b>	 z.B. Vorsachnummern / diverse
--	--	--	--	--	--------------------	---	--------------------------------------

## CITROEN

C3 II (09-)	1,0 VTi 68	3) Coull	10.2012		03.0520-9620.3	699620	ATE TOPKIT	4242 45	
	1,1	3) Coull	09.2009		03.0520-9620.3	699620	ATE TOPKIT	4242 45	
	1,2 VTi 110	3) Coull	10.2014		03.0520-9620.3	699620	ATE TOPKIT	4242 45	
	1,2 VTi 82	3) Coull	10.2012		03.0520-9620.3	699620	ATE TOPKIT	4242 45	
	1,4	3) Coull	09.2009		03.0520-9620.3	699620	ATE TOPKIT	4242 45	
	1,4 Flex	3) Coull	11.2009		03.0520-9620.3	699620	ATE TOPKIT	4242 45	
	1,4 HDi 70	3) Coull	11.2009		03.0520-9620.3	699620	ATE TOPKIT	4242 45	
	1,6 HDi	3) Coull	11.2009		03.0520-9620.3	699620	ATE TOPKIT	4242 45	
	1,6 HDi 90	3) Coull	09.2009		03.0520-9620.3	699620	ATE TOPKIT	4242 45	
C4 CACTUS (14-)	1,2 THP 110	3) Coull	09.2014		03.0520-9620.3	699620	ATE TOPKIT	4242 45	
	1,2 VTi 75	3) Coull	05.2014		03.0520-9620.3	699620	ATE TOPKIT	4242 45	
	1,2 VTi 82	3) Coull	05.2014		03.0520-9620.3	699620	ATE TOPKIT	4242 45	
	1,6 e-HDi 92	3) Coull	05.2014		03.0520-9620.3	699620	ATE TOPKIT	4242 45	
	1,6 HDi 100	3) Coull	09.2014		03.0520-9620.3	699620	ATE TOPKIT	4242 45	
C4 II GRAND PICASSO (13-)	1,2 THP 130	3) Coull	04.2014		13.0460-7300.2	607300	BELAGSATZ	16 124 123 80 , 16 098 985 80	s. Abb.
	1,6 BlueHDi 120	3) Coull	07.2014		13.0460-7300.2	607300	BELAGSATZ	16 124 123 80 , 16 098 985 80	s. Abb.
	1,6 HDi 115	3) Coull	08.2013		13.0460-7300.2	607300	BELAGSATZ	16 124 123 80 , 16 098 985 80	s. Abb.
	1,6 HDi 90	3) Coull	08.2013		13.0460-7300.2	607300	BELAGSATZ	16 124 123 80 , 16 098 985 80	s. Abb.
	1,6 THP 155	3) Coull	08.2013		13.0460-7300.2	607300	BELAGSATZ	16 124 123 80 , 16 098 985 80	s. Abb.



					<b>Bezeichnung</b>	<b>OE-Nummern zu ATE Artikelnummern</b>	 z.B. Vorsachnummern / diverse
--	--	--	--	--	--------------------	---	--------------------------------------

## CITROEN

C4 II GRAND PICASSO (13-)	1,6 THP 165	3) Coull	07.2014		13.0460-7300.2	607300	BELAGSATZ	16 124 123 80 , 16 098 985 80	s. Abb.
	1,6 VTi 120	3) Coull	08.2013		13.0460-7300.2	607300	BELAGSATZ	16 124 123 80 , 16 098 985 80	s. Abb.
	2,0 HDi 150	3) Coull	09.2013		13.0460-7300.2	607300	BELAGSATZ	16 124 123 80 , 16 098 985 80	s. Abb.
C4 II PICASSO (13-)	1,2 THP 130	3) Coull	04.2014		13.0460-7300.2	607300	BELAGSATZ	16 124 123 80 , 16 098 985 80	s. Abb.
	1,6 BlueHDi 100	3) Coull	12.2014		13.0460-7300.2	607300	BELAGSATZ	16 124 123 80 , 16 098 985 80	s. Abb.
	1,6 BlueHDi 120	3) Coull	07.2014		13.0460-7300.2	607300	BELAGSATZ	16 124 123 80 , 16 098 985 80	s. Abb.
	1,6 HDi 115	3) Coull	06.2013		13.0460-7300.2	607300	BELAGSATZ	16 124 123 80 , 16 098 985 80	s. Abb.
	1,6 HDi 90	3) Coull	06.2013		13.0460-7300.2	607300	BELAGSATZ	16 124 123 80 , 16 098 985 80	s. Abb.
	1,6 THP 155	3) Coull	06.2013		13.0460-7300.2	607300	BELAGSATZ	16 124 123 80 , 16 098 985 80	s. Abb.
	1,6 THP 165	3) Coull	07.2014		13.0460-7300.2	607300	BELAGSATZ	16 124 123 80 , 16 098 985 80	s. Abb.
	1,6 VTi 120	3) Coull	06.2013		13.0460-7300.2	607300	BELAGSATZ	16 124 123 80 , 16 098 985 80	s. Abb.
	2,0 HDi 150	3) Coull	09.2013		13.0460-7300.2	607300	BELAGSATZ	16 124 123 80 , 16 098 985 80	s. Abb.
C-ELYSEE (12-)	1,2 VTi 72	3) Coull	11.2012		03.0520-9720.3	699720	ATE TOPKIT	16 071 390 80	
	1,6 HDi 92	3) Coull	11.2012		03.0520-9720.3	699720	ATE TOPKIT	16 071 390 80	
	1,6 VTi 115	3) Coull	11.2012		03.0520-9720.3	699720	ATE TOPKIT	16 071 390 80	
DS3 (09-)	1,2 VTi 110	3) Coull	10.2014		03.0520-9620.3	699620	ATE TOPKIT	4242 45	







					<b>Bezeichnung</b>	<b>OE-Nummern zu ATE Artikelnummern</b>	 z.B. Vorsachnummern / diverse
--	--	--	--	--	--------------------	---	--------------------------------------

## CITROEN

DS3 (09-)	1,2 VTi 82	3) Coupl	10.2012		03.0520-9620.3	699620	ATE TOPKIT	4242 45	
	1,4 HDi 70	3) Coupl	04.2010		03.0520-9620.3	699620	ATE TOPKIT	4242 45	
	1,6 HDi 100	3) Coupl	07.2014		03.0520-9620.3	699620	ATE TOPKIT	4242 45	
	1,6 HDi 90	3) Coupl	11.2009		03.0520-9620.3	699620	ATE TOPKIT	4242 45	
DS3 Cabrio (13-)	1,2 PureTech VTi 82	3) Coupl	03.2013		03.0520-9620.3	699620	ATE TOPKIT	4242 45	
	1,6 e-HDi 90	3) Coupl	03.2013		03.0520-9620.3	699620	ATE TOPKIT	4242 45	
	1,6 HDi 100	3) Coupl	07.2014		03.0520-9620.3	699620	ATE TOPKIT	4242 45	
DS5 (11-)	1,6 HDi 110	3) Coupl	11.2011		03.7860-3732.4	300306	BREMSGERAET T5x	16 112 440 80 , 4535 CF	
	1,6 HDi 115	3) Coupl	08.2012		03.7860-3732.4	300306	BREMSGERAET T5x	16 112 440 80 , 4535 CF	
	1,6 HDi 120	3) Coupl	11.2013		03.7860-3732.4	300306	BREMSGERAET T5x	16 112 440 80 , 4535 CF	
	1,6 THP 155	3) Coupl	11.2011		03.7860-3732.4	300306	BREMSGERAET T5x	16 112 440 80 , 4535 CF	
	1,6 THP 200	3) Coupl	11.2011		03.7860-3732.4	300306	BREMSGERAET T5x	16 112 440 80 , 4535 CF	
	2,0 HDi 135	3) Coupl	11.2011		03.7860-3732.4	300306	BREMSGERAET T5x	16 112 440 80 , 4535 CF	
	2,0 HDi 150	3) Coupl	07.2014		03.7860-3732.4	300306	BREMSGERAET T5x	16 112 440 80 , 4535 CF	
	2,0 HDi 165	3) Coupl	11.2011		03.7860-3732.4	300306	BREMSGERAET T5x	16 112 440 80 , 4535 CF	
	2,0 HDi 180	3) Coupl	08.2013		03.7860-3732.4	300306	BREMSGERAET T5x	16 112 440 80 , 4535 CF	



					<b>Bezeichnung</b>	<b>OE-Nummern zu ATE Artikelnummern</b>	 <b>z.B. Vorsachnummern / diverse</b>
---	---	---	--	---	--------------------	---	---

## Classic PKW

MERCEDES BENZ G-Klasse (W460) (79-93)	200 GE	VR	05.1986	07.1993	13.9441-0042.2	210280	FESTSATTEL	004 420 82 83 , 461 420 08 02 , 000 420 15 01	13.4441-8012.3
		VL	05.1986	07.1993	13.9441-0041.2	210279	FESTSATTEL	004 420 81 83 , 461 420 07 02 , 000 420 14 01	13.4441-8011.3
	230 G	VR	02.1979	08.1985	13.9441-0042.2	210280	FESTSATTEL	004 420 82 83 , 461 420 08 02 , 000 420 15 01	13.4441-8012.3
		VL	02.1979	08.1985	13.9441-0041.2	210279	FESTSATTEL	004 420 81 83 , 461 420 07 02 , 000 420 14 01	13.4441-8011.3
	230 GE	VL	04.1982	07.1993	13.9441-0041.2	210279	FESTSATTEL	004 420 81 83 , 461 420 07 02 , 000 420 14 01	13.4441-8011.3
		VR	04.1982	07.1993	13.9441-0042.2	210280	FESTSATTEL	004 420 82 83 , 461 420 08 02 , 000 420 15 01	13.4441-8012.3
	240 GD	VL	02.1979	07.1993	13.9441-0041.2	210279	FESTSATTEL	004 420 81 83 , 461 420 07 02 , 000 420 14 01	13.4441-8011.3
		VR	02.1979	07.1993	13.9441-0042.2	210280	FESTSATTEL	004 420 82 83 , 461 420 08 02 , 000 420 15 01	13.4441-8012.3
	250 GD	VL	08.1987	07.1993	13.9441-0041.2	210279	FESTSATTEL	004 420 81 83 , 461 420 07 02 , 000 420 14 01	13.4441-8011.3
		VR	08.1987	07.1993	13.9441-0042.2	210280	FESTSATTEL	004 420 82 83 , 461 420 08 02 , 000 420 15 01	13.4441-8012.3
	280 GE	VL	02.1979	07.1993	13.9441-0041.2	210279	FESTSATTEL	004 420 81 83 , 461 420 07 02 , 000 420 14 01	13.4441-8011.3
		VR	02.1979	07.1993	13.9441-0042.2	210280	FESTSATTEL	004 420 82 83 , 461 420 08 02 , 000 420 15 01	13.4441-8012.3
	300 GD	VL	02.1979	07.1993	13.9441-0041.2	210279	FESTSATTEL	004 420 81 83 , 461 420 07 02 , 000 420 14 01	13.4441-8011.3
		VR	02.1979	07.1993	13.9441-0042.2	210280	FESTSATTEL	004 420 82 83 , 461 420 08 02 , 000 420 15 01	13.4441-8012.3



	<b>i</b>			<b>Bezeichnung</b>	<b>OE-Nummern zu ATE Artikelnummern</b>	<b>i</b> z.B. Vorsachnummern / diverse
--	----------	--	--	--------------------	---	--

## Classic PKW

MERCEDES BENZ G-Klasse (W461) (90-)	230 GE	VL	02.1993		13.9441-0041.2	210279	FESTSATTEL	004 420 81 83 , 461 420 07 02 , 000 420 14 01	13.4441-8011.3
		VR	02.1993		13.9441-0042.2	210280	FESTSATTEL	004 420 82 83 , 461 420 08 02 , 000 420 15 01	13.4441-8012.3
	250 GD	VR	02.1990		13.9441-0042.2	210280	FESTSATTEL	004 420 82 83 , 461 420 08 02 , 000 420 15 01	13.4441-8012.3
		VL	02.1990		13.9441-0041.2	210279	FESTSATTEL	004 420 81 83 , 461 420 07 02 , 000 420 14 01	13.4441-8011.3
	290 GD	VL	04.1992		13.9441-0041.2	210279	FESTSATTEL	004 420 81 83 , 461 420 07 02 , 000 420 14 01	13.4441-8011.3
		VR	04.1992		13.9441-0042.2	210280	FESTSATTEL	004 420 82 83 , 461 420 08 02 , 000 420 15 01	13.4441-8012.3
	G 270 CDI	VR	01.2003		13.9441-0042.2	210280	FESTSATTEL	004 420 82 83 , 461 420 08 02 , 000 420 15 01	13.4441-8012.3
		VL	01.2003		13.9441-0041.2	210279	FESTSATTEL	004 420 81 83 , 461 420 07 02 , 000 420 14 01	13.4441-8011.3
	G 290 TD	VL	07.1997		13.9441-0041.2	210279	FESTSATTEL	004 420 81 83 , 461 420 07 02 , 000 420 14 01	13.4441-8011.3
		VR	07.1997		13.9441-0042.2	210280	FESTSATTEL	004 420 82 83 , 461 420 08 02 , 000 420 15 01	13.4441-8012.3



Bezeichnung

OE-Nummern  
zu ATE  
Artikelnummern



z.B. Vorsachnummern /  
diverse

## DACIA

DUSTER (HS_) (10-)	1,5 dCi	3) Coull	04.2010	10.2013	03.2122-2261.3	010964	TANDEM MASTER CYLINDE	46 01 199 52R	
		3) Coull	06.2010	10.2013	03.2122-2261.3	010964	TANDEM MASTER CYLINDE	46 01 199 52R	
		3) Coull	10.2010	10.2013	03.2122-2261.3	010964	TANDEM MASTER CYLINDE	46 01 199 52R	
	1,5 dCi 4x4	3) Coull	08.2013		03.2122-2261.3	010964	TANDEM MASTER CYLINDE	46 01 199 52R	
		3) Coull	06.2010	10.2013	03.2122-2261.3	010964	TANDEM MASTER CYLINDE	46 01 199 52R	
		3) Coull	10.2010	10.2013	03.2122-2261.3	010964	TANDEM MASTER CYLINDE	46 01 199 52R	
	1,6 16V	3) Coull	04.2010	10.2013	03.2122-2261.3	010964	TANDEM MASTER CYLINDE	46 01 199 52R	
	1,6 16V 4x4	3) Coull	06.2010	10.2013	03.2122-2261.3	010964	TANDEM MASTER CYLINDE	46 01 199 52R	
	1,6 16V LPG	3) Coull	04.2011	10.2013	03.2122-2261.3	010964	TANDEM MASTER CYLINDE	46 01 199 52R	

## DAEWOO

MATIZ (98-05)	0,8 (KLA4)	3) Coull	07.1998	02.2005	24.2120-1755.3	010974	TANDEM MASTER CYLINDE	96316463	
	1,0 (KLA0)	3) Coull	01.2003	02.2005	24.2120-1755.3	010974	TANDEM MASTER CYLINDE	96316463	





	<b>i</b>				<b>Bezeichnung</b>	<b>OE-Nummern zu ATE Artikelnummern</b>	<b>i</b> z.B. Vorsachnummern / diverse
--	----------	--	--	--	--------------------	---	--

## FORD

B-MAX (12-)	1,0 EcoBoost	3) Cour	10.2012		24.0123-0122.1	423122	BREMSSCHEIBE	EY16-1125-AA , 1833857 , AY11-1125-AA , 1751584
	1,4 Duratec	3) Cour	10.2012		24.0123-0122.1	423122	BREMSSCHEIBE	EY16-1125-AA , 1833857 , AY11-1125-AA , 1751584
	1,4 LPG	3) Cour	08.2013		24.0123-0122.1	423122	BREMSSCHEIBE	EY16-1125-AA , 1833857 , AY11-1125-AA , 1751584
	1,5 TDCi	3) Cour	10.2012		24.0123-0122.1	423122	BREMSSCHEIBE	EY16-1125-AA , 1833857 , AY11-1125-AA , 1751584
	1,6 TDCi	3) Cour	10.2012		24.0123-0122.1	423122	BREMSSCHEIBE	EY16-1125-AA , 1833857 , AY11-1125-AA , 1751584
	1,6 Ti-VCT	3) Cour	10.2012		24.0123-0122.1	423122	BREMSSCHEIBE	EY16-1125-AA , 1833857 , AY11-1125-AA , 1751584
FIESTA VI (08-)	1,6 EcoBoost ST	3) Cour	01.2013		24.0123-0122.1	423122	BREMSSCHEIBE	EY16-1125-AA , 1833857 , AY11-1125-AA , 1751584
TRANSIT COURIER / TOURNEO COURIER (14-)	1,0 EcoBoost	3) Cour	02.2014		24.0123-0122.1	423122	BREMSSCHEIBE	EY16-1125-AA , 1833857 , AY11-1125-AA , 1751584
	1,5 TDCi	3) Cour	02.2014		24.0123-0122.1	423122	BREMSSCHEIBE	EY16-1125-AA , 1833857 , AY11-1125-AA , 1751584
	1,6 TDCi	3) Cour	02.2014		24.0123-0122.1	423122	BREMSSCHEIBE	EY16-1125-AA , 1833857 , AY11-1125-AA , 1751584



					<b>Bezeichnung</b>	<b>OE-Nummern zu ATE Artikelnummern</b>	 z.B. Vorsachnummern / diverse
--	--	--	--	--	--------------------	---	--------------------------------------

## HYUNDAI

GRAND SANTA FE (13-)	2,2 CRDi Allrad	3) Coull	06.2013		13.0460-5633.2	605633	BELAGSATZ	58302-2WA70 , 58302-2PA70	s. Abb.
H-1 KASTEN (00-07)	2,4	3) Coull	11.2001	04.2004	13.0460-5637.2	605637	BELAGSATZ	58302-4AA00	s. Abb.
	2,5 CRDi	3) Coull	07.2001	04.2004	13.0460-5637.2	605637	BELAGSATZ	58302-4AA00	s. Abb.
		3) Coull	08.2003	04.2004	13.0460-5637.2	605637	BELAGSATZ	58302-4AA00	s. Abb.
	2,6 CRDi	3) Coull	08.2005	12.2007	13.0460-5637.2	605637	BELAGSATZ	58302-4AA00	s. Abb.
SANTA FE II (CM) (06-12)	2,0 CRDi	3) Coull	12.2010		13.0460-5633.2	605633	BELAGSATZ	58302-2WA70 , 58302-2PA70	s. Abb.
	2,0 CRDi 4x4	3) Coull	12.2010		13.0460-5633.2	605633	BELAGSATZ	58302-2WA70 , 58302-2PA70	s. Abb.
	2,2 CRDi	3) Coull	01.2009		13.0460-5633.2	605633	BELAGSATZ	58302-2WA70 , 58302-2PA70	s. Abb.
	2,2 CRDi 4x4	3) Coull	01.2009		13.0460-5633.2	605633	BELAGSATZ	58302-2WA70 , 58302-2PA70	s. Abb.
	2,4	3) Coull	07.2010		13.0460-5633.2	605633	BELAGSATZ	58302-2WA70 , 58302-2PA70	s. Abb.
	2,4 4x4	3) Coull	07.2010		13.0460-5633.2	605633	BELAGSATZ	58302-2WA70 , 58302-2PA70	s. Abb.
SANTA FE III (DM) (12-)	2,0 CRDi	3) Coull	09.2012		13.0460-5633.2	605633	BELAGSATZ	58302-2WA70 , 58302-2PA70	s. Abb.
	2,0 CRDi 4WD	3) Coull	09.2012		13.0460-5633.2	605633	BELAGSATZ	58302-2WA70 , 58302-2PA70	s. Abb.
	2,2 CRDi	3) Coull	09.2012		13.0460-5633.2	605633	BELAGSATZ	58302-2WA70 , 58302-2PA70	s. Abb.
	2,2 CRDi 4WD	3) Coull	09.2012		13.0460-5633.2	605633	BELAGSATZ	58302-2WA70 , 58302-2PA70	s. Abb.
	2,4 16V	3) Coull	09.2012		13.0460-5633.2	605633	BELAGSATZ	58302-2WA70 , 58302-2PA70	s. Abb.
	2,4 16V 4WD	3) Coull	09.2012		13.0460-5633.2	605633	BELAGSATZ	58302-2WA70 , 58302-2PA70	s. Abb.
	2,4 GDi 4WD	3) Coull	09.2012		13.0460-5633.2	605633	BELAGSATZ	58302-2WA70 , 58302-2PA70	s. Abb.



					<b>Bezeichnung</b>	<b>OE-Nummern zu ATE Artikelnummern</b>	 z.B. Vorsachnummern / diverse
--	--	--	--	--	--------------------	---	-----------------------------------

## KIA

SORENTO (XM) (09-14)	2,0 CRDi	3) Coull	11.2010	12.2014	13.0460-5633.2	605633	BELAGSATZ	58302-2WA70 , 58302-2PA70	s. Abb.
	2,0 CRDi 4WD	3) Coull	11.2010	12.2014	13.0460-5633.2	605633	BELAGSATZ	58302-2WA70 , 58302-2PA70	s. Abb.
	2,2 CRDi	3) Coull	11.2009	12.2014	13.0460-5633.2	605633	BELAGSATZ	58302-2WA70 , 58302-2PA70	s. Abb.
	2,2 CRDi 4WD	3) Coull	11.2009	12.2014	13.0460-5633.2	605633	BELAGSATZ	58302-2WA70 , 58302-2PA70	s. Abb.
	2,4 16V	3) Coull	11.2009	12.2014	13.0460-5633.2	605633	BELAGSATZ	58302-2WA70 , 58302-2PA70	s. Abb.
	2,4 16V 4WD	3) Coull	11.2009	12.2014	13.0460-5633.2	605633	BELAGSATZ	58302-2WA70 , 58302-2PA70	s. Abb.
VENGA (10-)	1,4 CRDi 75	3) Coull	02.2010		13.0460-2772.2	602772	BELAGSATZ		s. Abb.
		3) Coull	02.2010		24.4122-1716.3	010983	TANDEM MASTER CYLINDE	58510-1P130 , 58510-1P100	
	1,4 CRDi 90	3) Coull	02.2010		13.0460-2772.2	602772	BELAGSATZ		s. Abb.
		3) Coull	02.2010		24.4122-1716.3	010983	TANDEM MASTER CYLINDE	58510-1P130 , 58510-1P100	
	1,4 CVVT	3) Coull	02.2010		13.0460-2772.2	602772	BELAGSATZ		s. Abb.
		3) Coull	02.2010		24.4122-1716.3	010983	TANDEM MASTER CYLINDE	58510-1P130 , 58510-1P100	
	1,6 CRDi 115	3) Coull	02.2010		13.0460-2772.2	602772	BELAGSATZ		s. Abb.
		3) Coull	02.2010		24.4122-1716.3	010983	TANDEM MASTER CYLINDE	58510-1P130 , 58510-1P100	
	1,6 CRDi 128	3) Coull	02.2010		13.0460-2772.2	602772	BELAGSATZ		s. Abb.
		3) Coull	02.2010		24.4122-1716.3	010983	TANDEM MASTER CYLINDE	58510-1P130 , 58510-1P100	
	1,6 CVVT	3) Coull	02.2010		13.0460-2772.2	602772	BELAGSATZ		s. Abb.
		3) Coull	02.2010		24.4122-1716.3	010983	TANDEM MASTER CYLINDE	58510-1P130 , 58510-1P100	







					<b>Bezeichnung</b>	<b>OE-Nummern zu ATE Artikelnummern</b>	 z.B. Vorsachnummern / diverse
--	--	--	--	--	--------------------	---	-----------------------------------

## MAZDA

6 Kombi (GY) (02-07)	1,8 16V	3) Coup	08.2002	07.2007	24.2120-1756.3	010975	TANDEM MASTER CYLINDE	GJ6L-43-40ZA , GJ6L-43-40Z	
	2,0 16V	3) Coup	03.2005	07.2007	24.2120-1756.3	010975	TANDEM MASTER CYLINDE	GJ6L-43-40ZA , GJ6L-43-40Z	
		3) Coup	08.2002	07.2007	24.2120-1756.3	010975	TANDEM MASTER CYLINDE	GJ6L-43-40ZA , GJ6L-43-40Z	
	2,0 CITD 4x4	3) Coup	10.2002	02.2005	24.2120-1756.3	010975	TANDEM MASTER CYLINDE	GJ6L-43-40ZA , GJ6L-43-40Z	
	2,0 DI	3) Coup	06.2005	07.2007	24.2120-1756.3	010975	TANDEM MASTER CYLINDE	GJ6L-43-40ZA , GJ6L-43-40Z	
		3) Coup	08.2002	07.2007	24.2120-1756.3	010975	TANDEM MASTER CYLINDE	GJ6L-43-40ZA , GJ6L-43-40Z	
	2,3 16V	3) Coup	08.2002	07.2007	24.2120-1756.3	010975	TANDEM MASTER CYLINDE	GJ6L-43-40ZA , GJ6L-43-40Z	
	2,3 16V AWD	3) Coup	11.2002	07.2007	24.2120-1756.3	010975	TANDEM MASTER CYLINDE	GJ6L-43-40ZA , GJ6L-43-40Z	
6 Limousine (GG) (02-07)	1,8 16V	3) Coup	08.2002	07.2007	24.2120-1756.3	010975	TANDEM MASTER CYLINDE	GJ6L-43-40ZA , GJ6L-43-40Z	
	2,0 16V	3) Coup	03.2005	07.2007	24.2120-1756.3	010975	TANDEM MASTER CYLINDE	GJ6L-43-40ZA , GJ6L-43-40Z	
		3) Coup	06.2002	07.2007	24.2120-1756.3	010975	TANDEM MASTER CYLINDE	GJ6L-43-40ZA , GJ6L-43-40Z	
	2,0 DI	3) Coup	06.2002	07.2007	24.2120-1756.3	010975	TANDEM MASTER CYLINDE	GJ6L-43-40ZA , GJ6L-43-40Z	
		3) Coup	06.2005	07.2007	24.2120-1756.3	010975	TANDEM MASTER CYLINDE	GJ6L-43-40ZA , GJ6L-43-40Z	
		3) Coup	08.2002	07.2007	24.2120-1756.3	010975	TANDEM MASTER CYLINDE	GJ6L-43-40ZA , GJ6L-43-40Z	
	2,3 16V	3) Coup	07.2003	02.2005	24.2120-1756.3	010975	TANDEM MASTER CYLINDE	GJ6L-43-40ZA , GJ6L-43-40Z	
		3) Coup	03.2005	07.2007	24.2120-1756.3	010975	TANDEM MASTER CYLINDE	GJ6L-43-40ZA , GJ6L-43-40Z	
		3) Coup	06.2002	07.2007	24.2120-1756.3	010975	TANDEM MASTER CYLINDE	GJ6L-43-40ZA , GJ6L-43-40Z	
	2,3 MPS Turbo	3) Coup	12.2005	07.2007	24.2120-1756.3	010975	TANDEM MASTER CYLINDE	GJ6L-43-40ZA , GJ6L-43-40Z	



					<b>Bezeichnung</b>	<b>OE-Nummern zu ATE Artikelnummern</b>	 z.B. Vorsachnummern / diverse
---	---	---	--	---	--------------------	---	---

## MERCEDES BENZ

A-Klasse (W176 ) (12-)	A 160 CDI	3) Coull	06.2013		13.0460-2779.2	602779	BELAGSATZ	008 420 06 20 , 006 420 85 20 , 006 420 46 20	s. Abb.
		3) Coull	06.2013		13.0460-2778.2	602778	BELAGSATZ	006 420 48 20	s. Abb.
		3) Coull	06.2013		13.0460-2786.2	602786	BELAGSATZ	007 420 94 20 , 007 420 95 20 , 006 420 79 20 , 006 420 83 20 , 006 420 80 20 , 006 420 23 20	s. Abb.
	A 180	3) Coull	06.2012		24.0128-0276.1	428276	BREMSSCHEIBE	246 421 01 12	
		3) Coull	06.2012		13.0460-2786.2	602786	BELAGSATZ	007 420 94 20 , 007 420 95 20 , 006 420 79 20 , 006 420 83 20 , 006 420 80 20 , 006 420 23 20	s. Abb.
		3) Coull	06.2012		13.0460-2779.2	602779	BELAGSATZ	008 420 06 20 , 006 420 85 20 , 006 420 46 20	s. Abb.
		3) Coull	06.2012		13.0460-2778.2	602778	BELAGSATZ	006 420 48 20	s. Abb.
	A 180 CDI	3) Coull	06.2012		13.0460-2786.2	602786	BELAGSATZ	007 420 94 20 , 007 420 95 20 , 006 420 79 20 , 006 420 83 20 , 006 420 80 20 , 006 420 23 20	s. Abb.
		3) Coull	06.2012		13.0460-2779.2	602779	BELAGSATZ	008 420 06 20 , 006 420 85 20 , 006 420 46 20	s. Abb.
		3) Coull	06.2012		13.0460-2778.2	602778	BELAGSATZ	006 420 48 20	s. Abb.
	A 200	3) Coull	06.2012		24.0128-0276.1	428276	BREMSSCHEIBE	246 421 01 12	
		3) Coull	06.2012		13.0460-2786.2	602786	BELAGSATZ	007 420 94 20 , 007 420 95 20 , 006 420 79 20 , 006 420 83 20 , 006 420 80 20 , 006 420 23 20	s. Abb.
		3) Coull	06.2012		13.0460-2779.2	602779	BELAGSATZ	008 420 06 20 , 006 420 85 20 , 006 420 46 20	s. Abb.
	A 200 CDI	3) Coull	02.2014		24.0128-0276.1	428276	BREMSSCHEIBE	246 421 01 12	



					<b>Bezeichnung</b>	<b>OE-Nummern zu ATE Artikelnummern</b>	 z.B. Vorsachnummern / diverse
--	--	--	--	--	--------------------	---	--------------------------------------

## MERCEDES BENZ

A-Klasse (W176 ) (12-)	A 200 CDI	3) Coull	06.2012	02.2014	24.0128-0276.1	428276	BREMSSCHEIBE	246 421 01 12	
		3) Coull	02.2014		13.0460-2786.2	602786	BELAGSATZ	007 420 94 20 , 007 420 95 20 , 006 420 79 20 , 006 420 83 20 , 006 420 80 20 , 006 420 23 20	s. Abb.
		3) Coull	06.2012	02.2014	13.0460-2786.2	602786	BELAGSATZ	007 420 94 20 , 007 420 95 20 , 006 420 79 20 , 006 420 83 20 , 006 420 80 20 , 006 420 23 20	s. Abb.
		3) Coull	02.2014		13.0460-2779.2	602779	BELAGSATZ	008 420 06 20 , 006 420 85 20 , 006 420 46 20	s. Abb.
		3) Coull	06.2012	02.2014	13.0460-2779.2	602779	BELAGSATZ	008 420 06 20 , 006 420 85 20 , 006 420 46 20	s. Abb.
	A 200 CDI 4-Matic	3) Coull	02.2014		24.0128-0276.1	428276	BREMSSCHEIBE	246 421 01 12	
		3) Coull	02.2014		13.0460-2786.2	602786	BELAGSATZ	007 420 94 20 , 007 420 95 20 , 006 420 79 20 , 006 420 83 20 , 006 420 80 20 , 006 420 23 20	s. Abb.
		3) Coull	02.2014		13.0460-2779.2	602779	BELAGSATZ	008 420 06 20 , 006 420 85 20 , 006 420 46 20	s. Abb.
	A 220 4-matic	3) Coull	05.2014		24.0130-0238.1	430238	BREMSSCHEIBE	246 421 27 12	
		3) Coull	05.2014		24.0128-0275.1	428275	BREMSSCHEIBE	246 421 24 12	
		3) Coull	05.2014		13.0460-2786.2	602786	BELAGSATZ	007 420 94 20 , 007 420 95 20 , 006 420 79 20 , 006 420 83 20 , 006 420 80 20 , 006 420 23 20	s. Abb.
		3) Coull	05.2014		13.0460-2779.2	602779	BELAGSATZ	008 420 06 20 , 006 420 85 20 , 006 420 46 20	s. Abb.
	A 220 CDI	3) Coull	06.2012		24.0128-0275.1	428275	BREMSSCHEIBE	246 421 24 12	
		3) Coull	06.2012		24.0130-0238.1	430238	BREMSSCHEIBE	246 421 27 12	



					<b>Bezeichnung</b>	<b>OE-Nummern zu ATE Artikelnummern</b>	 z.B. Vorsachnummern / diverse
--	--	--	--	--	--------------------	---	-----------------------------------

## MERCEDES BENZ

A-Klasse (W176 ) (12-)	A 220 CDI	3) Coull	06.2012		13.0460-2786.2	602786	BELAGSATZ	007 420 94 20 , 007 420 95 20 , 006 420 79 20 , 006 420 83 20 , 006 420 80 20 , 006 420 23 20	s. Abb.
		3) Coull	06.2012		13.0460-2779.2	602779	BELAGSATZ	008 420 06 20 , 006 420 85 20 , 006 420 46 20	s. Abb.
	A 220 CDI 4-Matic	3) Coull	09.2012		24.0130-0238.1	430238	BREMSSCHEIBE	246 421 27 12	
		3) Coull	09.2012		24.0128-0275.1	428275	BREMSSCHEIBE	246 421 24 12	
		3) Coull	09.2012		13.0460-2779.2	602779	BELAGSATZ	008 420 06 20 , 006 420 85 20 , 006 420 46 20	s. Abb.
		3) Coull	09.2012		13.0460-2786.2	602786	BELAGSATZ	007 420 94 20 , 007 420 95 20 , 006 420 79 20 , 006 420 83 20 , 006 420 80 20 , 006 420 23 20	s. Abb.
	A 250	3) Coull	06.2012		24.0130-0238.1	430238	BREMSSCHEIBE	246 421 27 12	
		3) Coull	06.2012		13.0460-2779.2	602779	BELAGSATZ	008 420 06 20 , 006 420 85 20 , 006 420 46 20	s. Abb.
		3) Coull	06.2012		13.0460-2786.2	602786	BELAGSATZ	007 420 94 20 , 007 420 95 20 , 006 420 79 20 , 006 420 83 20 , 006 420 80 20 , 006 420 23 20	s. Abb.
	A 250 4-Matic	3) Coull	06.2013		24.0130-0238.1	430238	BREMSSCHEIBE	246 421 27 12	
		3) Coull	06.2013		13.0460-2779.2	602779	BELAGSATZ	008 420 06 20 , 006 420 85 20 , 006 420 46 20	s. Abb.
		3) Coull	06.2013		13.0460-2786.2	602786	BELAGSATZ	007 420 94 20 , 007 420 95 20 , 006 420 79 20 , 006 420 83 20 , 006 420 80 20 , 006 420 23 20	s. Abb.



	<b>i</b>				<b>Bezeichnung</b>	<b>OE-Nummern zu ATE Artikelnummern</b>	<b>i</b> z.B. Vorsachnummern / diverse
--	----------	--	--	--	--------------------	---	--

## MERCEDES BENZ

B-Klasse (W246/W242) (11-)	B 160 CDI	3) Cou	05.2013		13.0460-2786.2	602786	BELAGSATZ	007 420 94 20 , 007 420 95 20 , 006 420 79 20 , 006 420 83 20 , 006 420 80 20 , 006 420 23 20	s. Abb.
		3) Cou	05.2013		13.0460-2778.2	602778	BELAGSATZ	006 420 48 20	s. Abb.
		3) Cou	05.2013		13.0460-2779.2	602779	BELAGSATZ	008 420 06 20 , 006 420 85 20 , 006 420 46 20	s. Abb.
	B 180	3) Cou	11.2011		13.0460-2786.2	602786	BELAGSATZ	007 420 94 20 , 007 420 95 20 , 006 420 79 20 , 006 420 83 20 , 006 420 80 20 , 006 420 23 20	s. Abb.
		3) Cou	11.2011		13.0460-2779.2	602779	BELAGSATZ	008 420 06 20 , 006 420 85 20 , 006 420 46 20	s. Abb.
		3) Cou	11.2011		13.0460-2778.2	602778	BELAGSATZ	006 420 48 20	s. Abb.
	B 180 CDI	3) Cou	11.2011		13.0460-2778.2	602778	BELAGSATZ	006 420 48 20	s. Abb.
		3) Cou	11.2011		13.0460-2786.2	602786	BELAGSATZ	007 420 94 20 , 007 420 95 20 , 006 420 79 20 , 006 420 83 20 , 006 420 80 20 , 006 420 23 20	s. Abb.
		3) Cou	11.2011		13.0460-2779.2	602779	BELAGSATZ	008 420 06 20 , 006 420 85 20 , 006 420 46 20	s. Abb.
	B 200 CDI	3) Cou	08.2014		24.0128-0275.1	428275	BREMSSCHEIBE	246 421 24 12	
		3) Cou	08.2014		24.0130-0238.1	430238	BREMSSCHEIBE	246 421 27 12	
		3) Cou	11.2011		13.0460-2778.2	602778	BELAGSATZ	006 420 48 20	s. Abb.
		3) Cou	08.2014		13.0460-2786.2	602786	BELAGSATZ	007 420 94 20 , 007 420 95 20 , 006 420 79 20 , 006 420 83 20 , 006 420 80 20 , 006 420 23 20	s. Abb.





					<b>Bezeichnung</b>	<b>OE-Nummern zu ATE Artikelnummern</b>	 z.B. Vorsachnummern / diverse
--	--	--	--	--	--------------------	---	-----------------------------------

## MERCEDES BENZ

B-Klasse (W246/W242) (11-)	B 200 CDI	3) Coull	11.2011		13.0460-2786.2	602786	BELAGSATZ	007 420 94 20 , 007 420 95 20 , 006 420 79 20 , 006 420 83 20 , 006 420 80 20 , 006 420 23 20	s. Abb.
		3) Coull	11.2011		13.0460-2779.2	602779	BELAGSATZ	008 420 06 20 , 006 420 85 20 , 006 420 46 20	s. Abb.
		3) Coull	08.2014		13.0460-2779.2	602779	BELAGSATZ	008 420 06 20 , 006 420 85 20 , 006 420 46 20	s. Abb.
	B 200 CDI 4-matic	3) Coull	08.2014		24.0130-0238.1	430238	BREMSSSCHEIBE	246 421 27 12	
		3) Coull	08.2014		24.0128-0275.1	428275	BREMSSSCHEIBE	246 421 24 12	
		3) Coull	08.2014		13.0460-2779.2	602779	BELAGSATZ	008 420 06 20 , 006 420 85 20 , 006 420 46 20	s. Abb.
		3) Coull	08.2014		13.0460-2786.2	602786	BELAGSATZ	007 420 94 20 , 007 420 95 20 , 006 420 79 20 , 006 420 83 20 , 006 420 80 20 , 006 420 23 20	s. Abb.
	B 200 CGI	3) Coull	11.2011		13.0460-2786.2	602786	BELAGSATZ	007 420 94 20 , 007 420 95 20 , 006 420 79 20 , 006 420 83 20 , 006 420 80 20 , 006 420 23 20	s. Abb.
		3) Coull	11.2011		13.0460-2779.2	602779	BELAGSATZ	008 420 06 20 , 006 420 85 20 , 006 420 46 20	s. Abb.
	B 200 Natural Gas	3) Coull	11.2012		13.0460-2786.2	602786	BELAGSATZ	007 420 94 20 , 007 420 95 20 , 006 420 79 20 , 006 420 83 20 , 006 420 80 20 , 006 420 23 20	s. Abb.
		3) Coull	11.2012		13.0460-2779.2	602779	BELAGSATZ	008 420 06 20 , 006 420 85 20 , 006 420 46 20	s. Abb.
	B 220 4-Matic	3) Coull	05.2013		24.0130-0238.1	430238	BREMSSSCHEIBE	246 421 27 12	
		3) Coull	09.2014		24.0130-0238.1	430238	BREMSSSCHEIBE	246 421 27 12	



					<b>Bezeichnung</b>	<b>OE-Nummern zu ATE Artikelnummern</b>	 z.B. Vorsachnummern / diverse
--	--	--	--	--	--------------------	---	-----------------------------------

## MERCEDES BENZ

B-Klasse (W246/W242) (11-)	B 220 4-matic	3) Coull	09.2014		24.0128-0275.1	428275	BREMSSCHEIBE	246 421 24 12	
		3) Coull	05.2013		24.0128-0275.1	428275	BREMSSCHEIBE	246 421 24 12	
		3) Coull	05.2013		13.0460-2786.2	602786	BELAGSATZ	007 420 94 20 , 007 420 95 20 , 006 420 79 20 , 006 420 83 20 , 006 420 80 20 , 006 420 23 20	s. Abb.
		3) Coull	09.2014		13.0460-2786.2	602786	BELAGSATZ	007 420 94 20 , 007 420 95 20 , 006 420 79 20 , 006 420 83 20 , 006 420 80 20 , 006 420 23 20	s. Abb.
		3) Coull	09.2014		13.0460-2779.2	602779	BELAGSATZ	008 420 06 20 , 006 420 85 20 , 006 420 46 20	s. Abb.
		3) Coull	05.2013		13.0460-2779.2	602779	BELAGSATZ	008 420 06 20 , 006 420 85 20 , 006 420 46 20	s. Abb.
	B 220 CDI	3) Coull	09.2014		24.0130-0238.1	430238	BREMSSCHEIBE	246 421 27 12	
		3) Coull	12.2012		24.0130-0238.1	430238	BREMSSCHEIBE	246 421 27 12	
		3) Coull	12.2012		24.0128-0275.1	428275	BREMSSCHEIBE	246 421 24 12	
		3) Coull	09.2014		24.0128-0275.1	428275	BREMSSCHEIBE	246 421 24 12	
		3) Coull	09.2014		13.0460-2779.2	602779	BELAGSATZ	008 420 06 20 , 006 420 85 20 , 006 420 46 20	s. Abb.
		3) Coull	12.2012		13.0460-2779.2	602779	BELAGSATZ	008 420 06 20 , 006 420 85 20 , 006 420 46 20	s. Abb.
		3) Coull	12.2012		13.0460-2786.2	602786	BELAGSATZ	007 420 94 20 , 007 420 95 20 , 006 420 79 20 , 006 420 83 20 , 006 420 80 20 , 006 420 23 20	s. Abb.
		3) Coull	09.2014		13.0460-2786.2	602786	BELAGSATZ	007 420 94 20 , 007 420 95 20 , 006 420 79 20 , 006 420 83 20 , 006 420 80 20 , 006 420 23 20	s. Abb.



					<b>Bezeichnung</b>	<b>OE-Nummern zu ATE Artikelnummern</b>	 z.B. Vorsachnummern / diverse
--	--	--	--	--	--------------------	---	-----------------------------------

## MERCEDES BENZ

B-Klasse (W246/W242) (11-)	B 250	3) Coull	09.2012		24.0130-0238.1	430238	BREMSSCHEIBE	246 421 27 12	
		3) Coull	09.2012		13.0460-2786.2	602786	BELAGSATZ	007 420 94 20 , 007 420 95 20 , 006 420 79 20 , 006 420 83 20 , 006 420 80 20 , 006 420 23 20	s. Abb.
		3) Coull	09.2012		13.0460-2779.2	602779	BELAGSATZ	008 420 06 20 , 006 420 85 20 , 006 420 46 20	s. Abb.
	B 250 4-matic	3) Coull	08.2014		24.0130-0238.1	430238	BREMSSCHEIBE	246 421 27 12	
		3) Coull	08.2014		13.0460-2786.2	602786	BELAGSATZ	007 420 94 20 , 007 420 95 20 , 006 420 79 20 , 006 420 83 20 , 006 420 80 20 , 006 420 23 20	s. Abb.
		3) Coull	08.2014		13.0460-2779.2	602779	BELAGSATZ	008 420 06 20 , 006 420 85 20 , 006 420 46 20	s. Abb.
	Electric Drive	3) Coull	11.2014		24.0128-0275.1	428275	BREMSSCHEIBE	246 421 24 12	
		3) Coull	11.2014		13.0460-2779.2	602779	BELAGSATZ	008 420 06 20 , 006 420 85 20 , 006 420 46 20	s. Abb.
		3) Coull	11.2014		13.0460-2786.2	602786	BELAGSATZ	007 420 94 20 , 007 420 95 20 , 006 420 79 20 , 006 420 83 20 , 006 420 80 20 , 006 420 23 20	s. Abb.
CITAN (W415) (12-)	108 CDI	3) Coull	09.2012		24.0126-0180.1	426180	BREMSSCHEIBE	415 421 04 12	
		3) Coull	09.2012		24.0111-0182.2	411182	BREMSSCHEIBE LAG.&SEN	40 20 240 76R , 43 20 043 27R , 415 420 01 02	
	108 CDI BE	3) Coull	09.2012		24.0126-0180.1	426180	BREMSSCHEIBE	415 421 04 12	
		3) Coull	09.2012		24.0111-0182.2	411182	BREMSSCHEIBE LAG.&SEN	40 20 240 76R , 43 20 043 27R , 415 420 01 02	
	109 CDI	3) Coull	09.2012		24.0126-0180.1	426180	BREMSSCHEIBE	415 421 04 12	



					<b>Bezeichnung</b>	<b>OE-Nummern zu ATE Artikelnummern</b>	 z.B. Vorsachnummern / diverse
--	--	--	--	--	--------------------	---	--------------------------------------

## MERCEDES BENZ

CITAN (W415) (12-)	109 CDI	3) Coupl	09.2012		24.0111-0182.2	411182	BREMSSCHEIBE LAG.&SEN	40 20 240 76R , 43 20 043 27R , 415 420 01 02
	109 CDI BE	3) Coupl	09.2012		24.0126-0180.1	426180	BREMSSCHEIBE	415 421 04 12
		3) Coupl	09.2012		24.0111-0182.2	411182	BREMSSCHEIBE LAG.&SEN	40 20 240 76R , 43 20 043 27R , 415 420 01 02
	111 CDI	3) Coupl	06.2013		24.0126-0180.1	426180	BREMSSCHEIBE	415 421 04 12
		3) Coupl	06.2013		24.0111-0182.2	411182	BREMSSCHEIBE LAG.&SEN	40 20 240 76R , 43 20 043 27R , 415 420 01 02
	111 CDI BE	3) Coupl	06.2013		24.0126-0180.1	426180	BREMSSCHEIBE	415 421 04 12
		3) Coupl	06.2013		24.0111-0182.2	411182	BREMSSCHEIBE LAG.&SEN	40 20 240 76R , 43 20 043 27R , 415 420 01 02
	112 BE	3) Coupl	06.2013		24.0126-0180.1	426180	BREMSSCHEIBE	415 421 04 12
		3) Coupl	06.2013		24.0111-0182.2	411182	BREMSSCHEIBE LAG.&SEN	40 20 240 76R , 43 20 043 27R , 415 420 01 02
C-Klasse (C204) Coupe (11-)	C 200 CGI	VR	06.2011		24.3606-1708.7	221012	FAUSTSATTEL	204 421 24 81 , 204 421 04 81
	C 220 CDI	VR	06.2011		24.3606-1708.7	221012	FAUSTSATTEL	204 421 24 81 , 204 421 04 81
	C 250 CDI	VR	06.2011		24.3606-1708.7	221012	FAUSTSATTEL	204 421 24 81 , 204 421 04 81
	C 250 CGI	VR	06.2011		24.3606-1708.7	221012	FAUSTSATTEL	204 421 24 81 , 204 421 04 81
C-Klasse (S204) Kombi (07-14)	C 200 CGI	VR	04.2009	08.2014	24.3606-1708.7	221012	FAUSTSATTEL	204 421 24 81 , 204 421 04 81
	C 200 Kompressor	VR	09.2007	08.2014	24.3606-1708.7	221012	FAUSTSATTEL	204 421 24 81 , 204 421 04 81
	C 220 CDI	VR	09.2007	08.2014	24.3606-1708.7	221012	FAUSTSATTEL	204 421 24 81 , 204 421 04 81



					<b>Bezeichnung</b>	<b>OE-Nummern zu ATE Artikelnummern</b>	 z.B. Vorsachnummern / diverse
--	--	--	--	--	--------------------	---	--------------------------------------

## MERCEDES BENZ

C-Klasse (S204) Kombi (07-14)	C 220 CDI	VR	12.2008	08.2014	24.3606-1708.7	221012	FAUSTSATTEL	204 421 24 81 , 204 421 04 81	
		VR	01.2007	08.2014	24.3606-1708.7	221012	FAUSTSATTEL	204 421 24 81 , 204 421 04 81	
	C 230	VR	09.2007	08.2014	24.3606-1708.7	221012	FAUSTSATTEL	204 421 24 81 , 204 421 04 81	
	C 250 CDI	VR	04.2009	08.2014	24.3606-1708.7	221012	FAUSTSATTEL	204 421 24 81 , 204 421 04 81	
	C 250 CGI	VR	04.2009	08.2014	24.3606-1708.7	221012	FAUSTSATTEL	204 421 24 81 , 204 421 04 81	
	C 280	VR	09.2007	08.2014	24.3606-1708.7	221012	FAUSTSATTEL	204 421 24 81 , 204 421 04 81	
	C 300	VR	08.2007	08.2014	24.3606-1708.7	221012	FAUSTSATTEL	204 421 24 81 , 204 421 04 81	
C-Klasse (W204) Limousine (07-14)	C 200	VR	05.2011	01.2014	24.3606-1708.7	221012	FAUSTSATTEL	204 421 24 81 , 204 421 04 81	
	C 200 CGI	VR	04.2009	01.2014	24.3606-1708.7	221012	FAUSTSATTEL	204 421 24 81 , 204 421 04 81	
	C 200 Kompressor	VR	03.2007	01.2014	24.3606-1708.7	221012	FAUSTSATTEL	204 421 24 81 , 204 421 04 81	
	C 220 CDI	VR	12.2008	01.2014	24.3606-1708.7	221012	FAUSTSATTEL	204 421 24 81 , 204 421 04 81	
		VR	03.2007	01.2014	24.3606-1708.7	221012	FAUSTSATTEL	204 421 24 81 , 204 421 04 81	
	C 230	VR	03.2007	01.2014	24.3606-1708.7	221012	FAUSTSATTEL	204 421 24 81 , 204 421 04 81	
	C 250 CDI	VR	08.2008	01.2014	24.3606-1708.7	221012	FAUSTSATTEL	204 421 24 81 , 204 421 04 81	



					<b>Bezeichnung</b>	<b>OE-Nummern zu ATE Artikelnummern</b>	 z.B. Vorsachnummern / diverse
--	--	--	--	--	--------------------	---	-----------------------------------

## MERCEDES BENZ

C-Klasse (W204) Limousine (07-14)	C 250 CGI	VR	04.2009	01.2014	24.3606-1708.7	221012	FAUSTSATTEL	204 421 24 81 , 204 421 04 81	
	C 280	VR	03.2007	01.2014	24.3606-1708.7	221012	FAUSTSATTEL	204 421 24 81 , 204 421 04 81	
	C 300	VR	07.2009	01.2014	24.3606-1708.7	221012	FAUSTSATTEL	204 421 24 81 , 204 421 04 81	
CLA-Klasse (C117) Coupe (13-)	CLA 180	3) Coup	01.2013		24.0128-0276.1	428276	BREMSSCHEIBE	246 421 01 12	
		3) Coup	01.2013		13.0460-2779.2	602779	BELAGSATZ	008 420 06 20 , 006 420 85 20 , 006 420 46 20	s. Abb.
		3) Coup	01.2013		13.0460-2786.2	602786	BELAGSATZ	007 420 94 20 , 007 420 95 20 , 006 420 79 20 , 006 420 83 20 , 006 420 80 20 , 006 420 23 20	s. Abb.
	CLA 180 BE	3) Coup	01.2013		24.0128-0276.1	428276	BREMSSCHEIBE	246 421 01 12	
		3) Coup	01.2013		13.0460-2786.2	602786	BELAGSATZ	007 420 94 20 , 007 420 95 20 , 006 420 79 20 , 006 420 83 20 , 006 420 80 20 , 006 420 23 20	s. Abb.
		3) Coup	01.2013		13.0460-2779.2	602779	BELAGSATZ	008 420 06 20 , 006 420 85 20 , 006 420 46 20	s. Abb.
	CLA 180 CDI	3) Coup	10.2013		24.0128-0276.1	428276	BREMSSCHEIBE	246 421 01 12	
		3) Coup	10.2013		13.0460-2779.2	602779	BELAGSATZ	008 420 06 20 , 006 420 85 20 , 006 420 46 20	s. Abb.
		3) Coup	10.2013		13.0460-2786.2	602786	BELAGSATZ	007 420 94 20 , 007 420 95 20 , 006 420 79 20 , 006 420 83 20 , 006 420 80 20 , 006 420 23 20	s. Abb.
	CLA 200	3) Coup	01.2013		24.0128-0276.1	428276	BREMSSCHEIBE	246 421 01 12	



					<b>Bezeichnung</b>	<b>OE-Nummern zu ATE Artikelnummern</b>	 z.B. Vorsachnummern / diverse
--	--	--	--	--	--------------------	---	--------------------------------------

## MERCEDES BENZ

CLA-Klasse (C117) Coupe (13-)	CLA 200	3) Coupl	01.2013		13.0460-2786.2	602786	BELAGSATZ	007 420 94 20 , 007 420 95 20 , 006 420 79 20 , 006 420 83 20 , 006 420 80 20 , 006 420 23 20	s. Abb.
		3) Coupl	01.2013		13.0460-2779.2	602779	BELAGSATZ	008 420 06 20 , 006 420 85 20 , 006 420 46 20	s. Abb.
	CLA 200 CDI	3) Coupl	07.2014		24.0128-0276.1	428276	BREMSSCHEIBE	246 421 01 12	
		3) Coupl	06.2013		24.0128-0276.1	428276	BREMSSCHEIBE	246 421 01 12	
		3) Coupl	07.2014		13.0460-2779.2	602779	BELAGSATZ	008 420 06 20 , 006 420 85 20 , 006 420 46 20	s. Abb.
		3) Coupl	07.2014		13.0460-2786.2	602786	BELAGSATZ	007 420 94 20 , 007 420 95 20 , 006 420 79 20 , 006 420 83 20 , 006 420 80 20 , 006 420 23 20	s. Abb.
		3) Coupl	06.2013		13.0460-2786.2	602786	BELAGSATZ	007 420 94 20 , 007 420 95 20 , 006 420 79 20 , 006 420 83 20 , 006 420 80 20 , 006 420 23 20	s. Abb.
		3) Coupl	06.2013		13.0460-2779.2	602779	BELAGSATZ	008 420 06 20 , 006 420 85 20 , 006 420 46 20	s. Abb.
	CLA 200 CDI 4-matic	3) Coupl	07.2014		24.0128-0276.1	428276	BREMSSCHEIBE	246 421 01 12	
		3) Coupl	07.2014		13.0460-2779.2	602779	BELAGSATZ	008 420 06 20 , 006 420 85 20 , 006 420 46 20	s. Abb.
		3) Coupl	07.2014		13.0460-2786.2	602786	BELAGSATZ	007 420 94 20 , 007 420 95 20 , 006 420 79 20 , 006 420 83 20 , 006 420 80 20 , 006 420 23 20	s. Abb.
	CLA 220 CDI	3) Coupl	09.2014		24.0128-0275.1	428275	BREMSSCHEIBE	246 421 24 12	
		3) Coupl	01.2013		24.0128-0275.1	428275	BREMSSCHEIBE	246 421 24 12	



					<b>Bezeichnung</b>	<b>OE-Nummern zu ATE Artikelnummern</b>	 z.B. Vorsachnummern / diverse
--	--	--	--	--	--------------------	---	--------------------------------------

## MERCEDES BENZ

CLA-Klasse (C117) Coupe (13-)	CLA 220 CDI	3) Coupl	09.2014		13.0460-2779.2	602779	BELAGSATZ	008 420 06 20 , 006 420 85 20 , 006 420 46 20	s. Abb.
		3) Coupl	01.2013		13.0460-2779.2	602779	BELAGSATZ	008 420 06 20 , 006 420 85 20 , 006 420 46 20	s. Abb.
		3) Coupl	09.2014		13.0460-2786.2	602786	BELAGSATZ	007 420 94 20 , 007 420 95 20 , 006 420 79 20 , 006 420 83 20 , 006 420 80 20 , 006 420 23 20	s. Abb.
		3) Coupl	01.2013		13.0460-2786.2	602786	BELAGSATZ	007 420 94 20 , 007 420 95 20 , 006 420 79 20 , 006 420 83 20 , 006 420 80 20 , 006 420 23 20	s. Abb.
	CLA 220 CDI 4-matic	3) Coupl	07.2014		24.0128-0275.1	428275	BREMSSCHEIBE	246 421 24 12	
		3) Coupl	07.2014		24.0130-0238.1	430238	BREMSSCHEIBE	246 421 27 12	
		3) Coupl	09.2014		24.0128-0275.1	428275	BREMSSCHEIBE	246 421 24 12	
		3) Coupl	09.2014		24.0130-0238.1	430238	BREMSSCHEIBE	246 421 27 12	
		3) Coupl	07.2014		13.0460-2779.2	602779	BELAGSATZ	008 420 06 20 , 006 420 85 20 , 006 420 46 20	s. Abb.
		3) Coupl	09.2014		13.0460-2779.2	602779	BELAGSATZ	008 420 06 20 , 006 420 85 20 , 006 420 46 20	s. Abb.
		3) Coupl	07.2014		13.0460-2786.2	602786	BELAGSATZ	007 420 94 20 , 007 420 95 20 , 006 420 79 20 , 006 420 83 20 , 006 420 80 20 , 006 420 23 20	s. Abb.
		3) Coupl	09.2014		13.0460-2786.2	602786	BELAGSATZ	007 420 94 20 , 007 420 95 20 , 006 420 79 20 , 006 420 83 20 , 006 420 80 20 , 006 420 23 20	s. Abb.
	CLA 250	3) Coupl	01.2013		24.0130-0238.1	430238	BREMSSCHEIBE	246 421 27 12	





					<b>Bezeichnung</b>	<b>OE-Nummern zu ATE Artikelnummern</b>	 z.B. Vorsachnummern / diverse
--	--	--	--	--	--------------------	---	--------------------------------------

## MERCEDES BENZ

CLA-Klasse (C117) Coupe (13-)	CLA 250	3) Coup	01.2013		13.0460-2779.2	602779	BELAGSATZ	008 420 06 20 , 006 420 85 20 , 006 420 46 20	s. Abb.
		3) Coup	01.2013		13.0460-2786.2	602786	BELAGSATZ	007 420 94 20 , 007 420 95 20 , 006 420 79 20 , 006 420 83 20 , 006 420 80 20 , 006 420 23 20	s. Abb.
	CLA 250 4-Matic	3) Coup	07.2013		24.0130-0238.1	430238	BREMSSCHEIBE	246 421 27 12	
		3) Coup	07.2013		13.0460-2779.2	602779	BELAGSATZ	008 420 06 20 , 006 420 85 20 , 006 420 46 20	s. Abb.
CLA-Klasse (X117) Shooting Brake (15-)	CLA 180	3) Coup	01.2015		24.0128-0276.1	428276	BREMSSCHEIBE	246 421 01 12	
		3) Coup	01.2015		13.0460-2786.2	602786	BELAGSATZ	007 420 94 20 , 007 420 95 20 , 006 420 79 20 , 006 420 83 20 , 006 420 80 20 , 006 420 23 20	s. Abb.
		3) Coup	01.2015		13.0460-2779.2	602779	BELAGSATZ	008 420 06 20 , 006 420 85 20 , 006 420 46 20	s. Abb.
	CLA 200	3) Coup	01.2015		24.0128-0276.1	428276	BREMSSCHEIBE	246 421 01 12	
		3) Coup	01.2015		13.0460-2786.2	602786	BELAGSATZ	007 420 94 20 , 007 420 95 20 , 006 420 79 20 , 006 420 83 20 , 006 420 80 20 , 006 420 23 20	s. Abb.
		3) Coup	01.2015		13.0460-2779.2	602779	BELAGSATZ	008 420 06 20 , 006 420 85 20 , 006 420 46 20	s. Abb.
	CLA 200 CDI	3) Coup	01.2015		24.0128-0276.1	428276	BREMSSCHEIBE	246 421 01 12	
		3) Coup	01.2015		13.0460-2786.2	602786	BELAGSATZ	007 420 94 20 , 007 420 95 20 , 006 420 79 20 , 006 420 83 20 , 006 420 80 20 , 006 420 23 20	s. Abb.
		3) Coup	01.2015		13.0460-2779.2	602779	BELAGSATZ	008 420 06 20 , 006 420 85 20 , 006 420 46 20	s. Abb.









					<b>Bezeichnung</b>	<b>OE-Nummern zu ATE Artikelnummern</b>	 z.B. Vorsachnummern / diverse
--	--	--	--	--	--------------------	---	--------------------------------------

## MERCEDES BENZ

CLA-Klasse (X117) Shooting Brake (15-)	CLA 220 CDI	3) Coull	01.2015		24.0128-0275.1	428275	BREMSSCHEIBE	246 421 24 12	
		3) Coull	01.2015		24.0130-0238.1	430238	BREMSSCHEIBE	246 421 27 12	
		3) Coull	01.2015		13.0460-2779.2	602779	BELAGSATZ	008 420 06 20 , 006 420 85 20 , 006 420 46 20	s. Abb.
		3) Coull	01.2015		13.0460-2786.2	602786	BELAGSATZ	007 420 94 20 , 007 420 95 20 , 006 420 79 20 , 006 420 83 20 , 006 420 80 20 , 006 420 23 20	s. Abb.
	CLA 250	3) Coull	01.2015		24.0130-0238.1	430238	BREMSSCHEIBE	246 421 27 12	
		3) Coull	01.2015		13.0460-2786.2	602786	BELAGSATZ	007 420 94 20 , 007 420 95 20 , 006 420 79 20 , 006 420 83 20 , 006 420 80 20 , 006 420 23 20	s. Abb.
		3) Coull	01.2015		13.0460-2779.2	602779	BELAGSATZ	008 420 06 20 , 006 420 85 20 , 006 420 46 20	s. Abb.
	CLA 250 4-matic	3) Coull	01.2015		24.0130-0238.1	430238	BREMSSCHEIBE	246 421 27 12	
		3) Coull	01.2015		13.0460-2779.2	602779	BELAGSATZ	008 420 06 20 , 006 420 85 20 , 006 420 46 20	s. Abb.
E-Klasse (A207) Cabrio (10-)	E 200	VR	03.2013		24.3606-1708.7	221012	FAUSTSATTEL	204 421 24 81 , 204 421 04 81	
	E 200 CGI	VR	03.2010		24.3606-1708.7	221012	FAUSTSATTEL	204 421 24 81 , 204 421 04 81	
	E 220 BlueTec	VR	05.2014		24.3606-1708.7	221012	FAUSTSATTEL	204 421 24 81 , 204 421 04 81	
	E 220 CDI	VR	03.2010		24.3606-1708.7	221012	FAUSTSATTEL	204 421 24 81 , 204 421 04 81	
	E 250 CDI	VR	03.2010		24.3606-1708.7	221012	FAUSTSATTEL	204 421 24 81 , 204 421 04 81	



					<b>Bezeichnung</b>	<b>OE-Nummern zu ATE Artikelnummern</b>	 z.B. Vorsachnummern / diverse
---	---	---	--	---	--------------------	---	---

## MERCEDES BENZ

E-Klasse (C207) Coupe (09-)	E 200	VR	03.2013		24.3606-1708.7	221012	FAUSTSATTEL	204 421 24 81 , 204 421 04 81	
	E 200 CGI	VR	09.2009		24.3606-1708.7	221012	FAUSTSATTEL	204 421 24 81 , 204 421 04 81	
	E 220 BlueTec	VR	05.2014		24.3606-1708.7	221012	FAUSTSATTEL	204 421 24 81 , 204 421 04 81	
	E 220 CDI	VR	07.2014		24.3606-1708.7	221012	FAUSTSATTEL	204 421 24 81 , 204 421 04 81	
		VR	05.2009		24.3606-1708.7	221012	FAUSTSATTEL	204 421 24 81 , 204 421 04 81	
	E 250 CGI	VR	05.2009		24.3606-1708.7	221012	FAUSTSATTEL	204 421 24 81 , 204 421 04 81	
E-Klasse (S212) Kombi (09-)	E 200	VR	03.2013		24.3606-1708.7	221012	FAUSTSATTEL	204 421 24 81 , 204 421 04 81	
	E 200 CDI	VR	11.2009		24.3606-1708.7	221012	FAUSTSATTEL	204 421 24 81 , 204 421 04 81	
	E 200 CGI	VR	11.2009		24.3606-1708.7	221012	FAUSTSATTEL	204 421 24 81 , 204 421 04 81	
	E 220 CDI	VR	11.2009		24.3606-1708.7	221012	FAUSTSATTEL	204 421 24 81 , 204 421 04 81	
E-Klasse (W212) Limousine (09-)	E 200	VR	01.2013		24.3606-1708.7	221012	FAUSTSATTEL	204 421 24 81 , 204 421 04 81	
	E 200 CDI	VR	03.2009		24.3606-1708.7	221012	FAUSTSATTEL	204 421 24 81 , 204 421 04 81	
	E 200 CGI	VR	08.2009		24.3606-1708.7	221012	FAUSTSATTEL	204 421 24 81 , 204 421 04 81	
	E 200 NGT	VR	03.2009		24.3606-1708.7	221012	FAUSTSATTEL	204 421 24 81 , 204 421 04 81	



	<b>i</b>				<b>Bezeichnung</b>	<b>OE-Nummern zu ATE Artikelnummern</b>	<b>i</b> z.B. Vorsachnummern / diverse
--	----------	--	--	--	--------------------	---	--

## MERCEDES BENZ

E-Klasse (W212) Limousine (09-)	E 200 NGT	VR	07.2013		24.3606-1708.7	221012	FAUSTSATTEL	204 421 24 81 , 204 421 04 81	
	E 220 BlueTec	VR	05.2014		24.3606-1708.7	221012	FAUSTSATTEL	204 421 24 81 , 204 421 04 81	
	E 220 CDI	VR	03.2009		24.3606-1708.7	221012	FAUSTSATTEL	204 421 24 81 , 204 421 04 81	
	E 250	VR	03.2009		24.3606-1708.7	221012	FAUSTSATTEL	204 421 24 81 , 204 421 04 81	
	E 250 CDI	VR	03.2009		24.3606-1708.7	221012	FAUSTSATTEL	204 421 24 81 , 204 421 04 81	
G-Klasse (W463) (90-)	200 GE	VR	01.1990		13.9441-0042.2	210280	FESTSATTEL	004 420 82 83 , 461 420 08 02 , 000 420 15 01	13.4441-8012.3
		VL	01.1990		13.9441-0041.2	210279	FESTSATTEL	004 420 81 83 , 461 420 07 02 , 000 420 14 01	13.4441-8011.3
	230 GE	VL	06.1990		13.9441-0041.2	210279	FESTSATTEL	004 420 81 83 , 461 420 07 02 , 000 420 14 01	13.4441-8011.3
		VR	06.1990		13.9441-0042.2	210280	FESTSATTEL	004 420 82 83 , 461 420 08 02 , 000 420 15 01	13.4441-8012.3
	250 GD	VR	06.1990		13.9441-0042.2	210280	FESTSATTEL	004 420 82 83 , 461 420 08 02 , 000 420 15 01	13.4441-8012.3
		VL	06.1990		13.9441-0041.2	210279	FESTSATTEL	004 420 81 83 , 461 420 07 02 , 000 420 14 01	13.4441-8011.3
	300 GD	VL	09.1989		13.9441-0041.2	210279	FESTSATTEL	004 420 81 83 , 461 420 07 02 , 000 420 14 01	13.4441-8011.3
		VR	09.1989		13.9441-0042.2	210280	FESTSATTEL	004 420 82 83 , 461 420 08 02 , 000 420 15 01	13.4441-8012.3
	300 GE	VL	06.1990		13.9441-0041.2	210279	FESTSATTEL	004 420 81 83 , 461 420 07 02 , 000 420 14 01	13.4441-8011.3







	<b>i</b>				<b>Bezeichnung</b>	<b>OE-Nummern zu ATE Artikelnummern</b>	<b>i</b> z.B. Vorsachnummern / diverse
--	----------	--	--	--	--------------------	---	--

## MERCEDES BENZ

G-Klasse (W463) (90-)	300 GE	VR	06.1990		13.9441-0042.2	210280	FESTSATTEL	004 420 82 83 , 461 420 08 02 , 000 420 15 01	13.4441-8012.3
	350 G Turbo	VL	09.1991		13.9441-0041.2	210279	FESTSATTEL	004 420 81 83 , 461 420 07 02 , 000 420 14 01	13.4441-8011.3
		VR	09.1991		13.9441-0042.2	210280	FESTSATTEL	004 420 82 83 , 461 420 08 02 , 000 420 15 01	13.4441-8012.3
	G 270 CDI	VL	10.2001		13.9441-0041.2	210279	FESTSATTEL	004 420 81 83 , 461 420 07 02 , 000 420 14 01	13.4441-8011.3
		VR	10.2001		13.9441-0042.2	210280	FESTSATTEL	004 420 82 83 , 461 420 08 02 , 000 420 15 01	13.4441-8012.3
	G 300 TD	VL	08.1996		13.9441-0041.2	210279	FESTSATTEL	004 420 81 83 , 461 420 07 02 , 000 420 14 01	13.4441-8011.3
		VR	08.1996		13.9441-0042.2	210280	FESTSATTEL	004 420 82 83 , 461 420 08 02 , 000 420 15 01	13.4441-8012.3
	G 320	VL	09.1994		13.9441-0041.2	210279	FESTSATTEL	004 420 81 83 , 461 420 07 02 , 000 420 14 01	13.4441-8011.3
		VR	09.1994		13.9441-0042.2	210280	FESTSATTEL	004 420 82 83 , 461 420 08 02 , 000 420 15 01	13.4441-8012.3
	G 350 CDI BlueTec	VR	06.2010		13.9441-0042.2	210280	FESTSATTEL	004 420 82 83 , 461 420 08 02 , 000 420 15 01	13.4441-8012.3
		VL	06.2010		13.9441-0041.2	210279	FESTSATTEL	004 420 81 83 , 461 420 07 02 , 000 420 14 01	13.4441-8011.3
	G 36 AMG	VR	01.1995		13.9441-0042.2	210280	FESTSATTEL	004 420 82 83 , 461 420 08 02 , 000 420 15 01	13.4441-8012.3
		VL	01.1995		13.9441-0041.2	210279	FESTSATTEL	004 420 81 83 , 461 420 07 02 , 000 420 14 01	13.4441-8011.3
	G 400 CDI	VL	12.2000		13.9441-0041.2	210279	FESTSATTEL	004 420 81 83 , 461 420 07 02 , 000 420 14 01	13.4441-8011.3









					<b>Bezeichnung</b>	<b>OE-Nummern zu ATE Artikelnummern</b>	 <b>z.B. Vorsachnummern / diverse</b>
---	---	---	--	---	--------------------	---	---

## MERCEDES BENZ

G-Klasse (W463) (90-)	G 400 CDI	VR	12.2000		13.9441-0042.2	210280	FESTSATTEL	004 420 82 83 , 461 420 08 02 , 000 420 15 01	13.4441-8012.3
	G 500	VL	04.1998		13.9441-0041.2	210279	FESTSATTEL	004 420 81 83 , 461 420 07 02 , 000 420 14 01	13.4441-8011.3
		VR	04.1998		13.9441-0042.2	210280	FESTSATTEL	004 420 82 83 , 461 420 08 02 , 000 420 15 01	13.4441-8012.3
	G 500 E	VL	09.1993		13.9441-0041.2	210279	FESTSATTEL	004 420 81 83 , 461 420 07 02 , 000 420 14 01	13.4441-8011.3
		VR	09.1993		13.9441-0042.2	210280	FESTSATTEL	004 420 82 83 , 461 420 08 02 , 000 420 15 01	13.4441-8012.3
	G 55 AMG	VR	04.1999		13.9441-0042.2	210280	FESTSATTEL	004 420 82 83 , 461 420 08 02 , 000 420 15 01	13.4441-8012.3
		VL	04.1999		13.9441-0041.2	210279	FESTSATTEL	004 420 81 83 , 461 420 07 02 , 000 420 14 01	13.4441-8011.3
G-Klasse (W463) Cabrio (90-)	200 GE	VL	01.1990		13.9441-0041.2	210279	FESTSATTEL	004 420 81 83 , 461 420 07 02 , 000 420 14 01	13.4441-8011.3
		VR	01.1990		13.9441-0042.2	210280	FESTSATTEL	004 420 82 83 , 461 420 08 02 , 000 420 15 01	13.4441-8012.3
	230 GE	VL	06.1990		13.9441-0041.2	210279	FESTSATTEL	004 420 81 83 , 461 420 07 02 , 000 420 14 01	13.4441-8011.3
		VR	06.1990		13.9441-0042.2	210280	FESTSATTEL	004 420 82 83 , 461 420 08 02 , 000 420 15 01	13.4441-8012.3
	300 GD	VR	12.1990		13.9441-0042.2	210280	FESTSATTEL	004 420 82 83 , 461 420 08 02 , 000 420 15 01	13.4441-8012.3
		VL	12.1990		13.9441-0041.2	210279	FESTSATTEL	004 420 81 83 , 461 420 07 02 , 000 420 14 01	13.4441-8011.3
	300 GE	VR	09.1989		13.9441-0042.2	210280	FESTSATTEL	004 420 82 83 , 461 420 08 02 , 000 420 15 01	13.4441-8012.3



					<b>Bezeichnung</b>	<b>OE-Nummern zu ATE Artikelnummern</b>	 <b>z.B. Vorsachnummern / diverse</b>
---	---	---	--	---	--------------------	---	---

## MERCEDES BENZ

G-Klasse (W463) Cabrio (90-)	300 GE	VL	09.1989		13.9441-0041.2	210279	FESTSATTEL	004 420 81 83 , 461 420 07 02 , 000 420 14 01	13.4441-8011.3
	320 GE	VR	09.1994		13.9441-0042.2	210280	FESTSATTEL	004 420 82 83 , 461 420 08 02 , 000 420 15 01	13.4441-8012.3
		VL	09.1994		13.9441-0041.2	210279	FESTSATTEL	004 420 81 83 , 461 420 07 02 , 000 420 14 01	13.4441-8011.3
	350 G Turbo	VR	09.1991		13.9441-0042.2	210280	FESTSATTEL	004 420 82 83 , 461 420 08 02 , 000 420 15 01	13.4441-8012.3
		VL	09.1991		13.9441-0041.2	210279	FESTSATTEL	004 420 81 83 , 461 420 07 02 , 000 420 14 01	13.4441-8011.3
	G 300 TD	VL	09.1996		13.9441-0041.2	210279	FESTSATTEL	004 420 81 83 , 461 420 07 02 , 000 420 14 01	13.4441-8011.3
		VR	09.1996		13.9441-0042.2	210280	FESTSATTEL	004 420 82 83 , 461 420 08 02 , 000 420 15 01	13.4441-8012.3
	G 320	VL	11.1997		13.9441-0041.2	210279	FESTSATTEL	004 420 81 83 , 461 420 07 02 , 000 420 14 01	13.4441-8011.3
		VR	11.1997		13.9441-0042.2	210280	FESTSATTEL	004 420 82 83 , 461 420 08 02 , 000 420 15 01	13.4441-8012.3
	G 400 CDI	VL	12.2000		13.9441-0041.2	210279	FESTSATTEL	004 420 81 83 , 461 420 07 02 , 000 420 14 01	13.4441-8011.3
		VR	12.2000		13.9441-0042.2	210280	FESTSATTEL	004 420 82 83 , 461 420 08 02 , 000 420 15 01	13.4441-8012.3
	G 500	VR	04.1998		13.9441-0042.2	210280	FESTSATTEL	004 420 82 83 , 461 420 08 02 , 000 420 15 01	13.4441-8012.3
		VL	04.1998		13.9441-0041.2	210279	FESTSATTEL	004 420 81 83 , 461 420 07 02 , 000 420 14 01	13.4441-8011.3
GLA-Klasse (X156) (13-)	GLA 180	3) Cou	02.2015		13.0460-2786.2	602786	BELAGSATZ	007 420 94 20 , 007 420 95 20 , 006 420 79 20 , 006 420 83 20 , 006 420 80 20 , 006 420 23 20	s. Abb.



					<b>Bezeichnung</b>	<b>OE-Nummern zu ATE Artikelnummern</b>	 z.B. Vorsachnummern / diverse
--	--	--	--	--	--------------------	---	-----------------------------------

## MERCEDES BENZ

GLA-Klasse (X156) (13-)	GLA 180 CDI	3) Coull	07.2014		24.0128-0276.1	428276	BREMSSCHEIBE	246 421 01 12	
		3) Coull	07.2014		13.0460-2779.2	602779	BELAGSATZ	008 420 06 20 , 006 420 85 20 , 006 420 46 20	s. Abb.
		3) Coull	07.2014		13.0460-2786.2	602786	BELAGSATZ	007 420 94 20 , 007 420 95 20 , 006 420 79 20 , 006 420 83 20 , 006 420 80 20 , 006 420 23 20	s. Abb.
	GLA 200	3) Coull	12.2013		24.0128-0276.1	428276	BREMSSCHEIBE	246 421 01 12	
		3) Coull	12.2013		13.0460-2779.2	602779	BELAGSATZ	008 420 06 20 , 006 420 85 20 , 006 420 46 20	s. Abb.
		3) Coull	12.2013		13.0460-2786.2	602786	BELAGSATZ	007 420 94 20 , 007 420 95 20 , 006 420 79 20 , 006 420 83 20 , 006 420 80 20 , 006 420 23 20	s. Abb.
	GLA 200 CDI	3) Coull	12.2013		24.0128-0275.1	428275	BREMSSCHEIBE	246 421 24 12	
		3) Coull	12.2013		13.0460-2779.2	602779	BELAGSATZ	008 420 06 20 , 006 420 85 20 , 006 420 46 20	s. Abb.
		3) Coull	12.2013		13.0460-2786.2	602786	BELAGSATZ	007 420 94 20 , 007 420 95 20 , 006 420 79 20 , 006 420 83 20 , 006 420 80 20 , 006 420 23 20	s. Abb.
	GLA 200 CDI 4-matic	3) Coull	12.2013		24.0128-0275.1	428275	BREMSSCHEIBE	246 421 24 12	
		3) Coull	12.2013		13.0460-2779.2	602779	BELAGSATZ	008 420 06 20 , 006 420 85 20 , 006 420 46 20	s. Abb.
		3) Coull	12.2013		13.0460-2786.2	602786	BELAGSATZ	007 420 94 20 , 007 420 95 20 , 006 420 79 20 , 006 420 83 20 , 006 420 80 20 , 006 420 23 20	s. Abb.
	GLA 220 CDI	3) Coull	12.2013		24.0128-0275.1	428275	BREMSSCHEIBE	246 421 24 12	
		3) Coull	12.2013		24.0130-0238.1	430238	BREMSSCHEIBE	246 421 27 12	









					<b>Bezeichnung</b>	<b>OE-Nummern zu ATE Artikelnummern</b>	 z.B. Vorsachnummern / diverse
--	--	--	--	--	--------------------	---	--------------------------------------

## MERCEDES BENZ

GLA-Klasse (X156) (13-)	GLA 220 CDI	3) Coull	12.2013		13.0460-2779.2	602779	BELAGSATZ	008 420 06 20 , 006 420 85 20 , 006 420 46 20	s. Abb.
		3) Coull	12.2013		13.0460-2786.2	602786	BELAGSATZ	007 420 94 20 , 007 420 95 20 , 006 420 79 20 , 006 420 83 20 , 006 420 80 20 , 006 420 23 20	s. Abb.
	GLA 220 CDI 4-matic	3) Coull	12.2013		24.0128-0275.1	428275	BREMSSCHEIBE	246 421 24 12	
		3) Coull	12.2013		13.0460-2779.2	602779	BELAGSATZ	008 420 06 20 , 006 420 85 20 , 006 420 46 20	s. Abb.
		3) Coull	12.2013		13.0460-2786.2	602786	BELAGSATZ	007 420 94 20 , 007 420 95 20 , 006 420 79 20 , 006 420 83 20 , 006 420 80 20 , 006 420 23 20	s. Abb.
	GLA 250	3) Coull	12.2013		24.0130-0238.1	430238	BREMSSCHEIBE	246 421 27 12	
		3) Coull	12.2013		13.0460-2779.2	602779	BELAGSATZ	008 420 06 20 , 006 420 85 20 , 006 420 46 20	s. Abb.
		3) Coull	12.2013		13.0460-2786.2	602786	BELAGSATZ	007 420 94 20 , 007 420 95 20 , 006 420 79 20 , 006 420 83 20 , 006 420 80 20 , 006 420 23 20	s. Abb.
	GLA 250 4-matic	3) Coull	12.2013		24.0130-0238.1	430238	BREMSSCHEIBE	246 421 27 12	
		3) Coull	12.2013		13.0460-2779.2	602779	BELAGSATZ	008 420 06 20 , 006 420 85 20 , 006 420 46 20	s. Abb.
S-Klasse (W221) (06-13)	S 400 Hybrid	3) Coull	06.2009	05.2013	03.4155-5141.3	010969	TANDEM MASTER CYLINDE	221 430 05 01	
SLK-Klasse (R172) (11-)	SLK 200	3) Coull	02.2011		13.0460-2786.2	602786	BELAGSATZ	007 420 94 20 , 007 420 95 20 , 006 420 79 20 , 006 420 83 20 , 006 420 80 20 , 006 420 23 20	s. Abb.
		VR	02.2011		24.3606-1708.7	221012	FAUSTSATTEL	204 421 24 81 , 204 421 04 81	









				<b>Bezeichnung</b>	<b>OE-Nummern zu ATE Artikelnummern</b>	 <b>z.B. Vorsachnummern / diverse</b>
---	---	--	---	--------------------	---	---

## MERCEDES BENZ

SLK-Klasse (R172) (11-)	SLK 250	3) Coupl	02.2011		13.0460-2786.2	602786	BELAGSATZ	007 420 94 20 , 007 420 95 20 , 006 420 79 20 , 006 420 83 20 , 006 420 80 20 , 006 420 23 20	s. Abb.
	SLK 250 CDI	3) Coupl	01.2012		13.0460-2786.2	602786	BELAGSATZ	007 420 94 20 , 007 420 95 20 , 006 420 79 20 , 006 420 83 20 , 006 420 80 20 , 006 420 23 20	s. Abb.
	SLK 350	3) Coupl	02.2011		13.0460-2786.2	602786	BELAGSATZ	007 420 94 20 , 007 420 95 20 , 006 420 79 20 , 006 420 83 20 , 006 420 80 20 , 006 420 23 20	s. Abb.



					<b>Bezeichnung</b>	<b>OE-Nummern zu ATE Artikelnummern</b>	 <b>z.B. Vorsachnummern / diverse</b>
---	---	---	--	---	--------------------	---	---

## MINI

R50 / R53 (00-06)	Cooper	3) Coull	06.2000	03.2003	11.8170-0584.1	260105	CALIPER MOUNT. BRACKET	34 21 6 768 462 , 34 21 6 757 246	11.0230-0162.2
		3) Coull	04.2003	11.2006	11.8170-0584.1	260105	CALIPER MOUNT. BRACKET	34 21 6 768 462 , 34 21 6 757 246	11.0230-0162.2
	Cooper S	3) Coull	07.2002	03.2003	11.8170-0584.1	260105	CALIPER MOUNT. BRACKET	34 21 6 768 462 , 34 21 6 757 246	11.0230-0162.2
		3) Coull	04.2003	11.2006	11.8170-0584.1	260105	CALIPER MOUNT. BRACKET	34 21 6 768 462 , 34 21 6 757 246	11.0230-0162.2
	Cooper S JCW	3) Coull	11.2003	11.2006	11.8170-0584.1	260105	CALIPER MOUNT. BRACKET	34 21 6 768 462 , 34 21 6 757 246	11.0230-0162.2
	One	3) Coull	04.2003	11.2006	11.8170-0584.1	260105	CALIPER MOUNT. BRACKET	34 21 6 768 462 , 34 21 6 757 246	11.0230-0162.2
		3) Coull	06.2000	03.2003	11.8170-0584.1	260105	CALIPER MOUNT. BRACKET	34 21 6 768 462 , 34 21 6 757 246	11.0230-0162.2
	One 1,4	3) Coull	04.2003	11.2006	11.8170-0584.1	260105	CALIPER MOUNT. BRACKET	34 21 6 768 462 , 34 21 6 757 246	11.0230-0162.2
		3) Coull	06.2000	03.2003	11.8170-0584.1	260105	CALIPER MOUNT. BRACKET	34 21 6 768 462 , 34 21 6 757 246	11.0230-0162.2
	One D	3) Coull	03.2003	03.2003	11.8170-0584.1	260105	CALIPER MOUNT. BRACKET	34 21 6 768 462 , 34 21 6 757 246	11.0230-0162.2
		3) Coull	04.2003	11.2006	11.8170-0584.1	260105	CALIPER MOUNT. BRACKET	34 21 6 768 462 , 34 21 6 757 246	11.0230-0162.2
R52 Cabrio (04-08)	Cooper	3) Coull	04.2004	08.2008	11.8170-0584.1	260105	CALIPER MOUNT. BRACKET	34 21 6 768 462 , 34 21 6 757 246	11.0230-0162.2
	Cooper S	3) Coull	04.2004	08.2008	11.8170-0584.1	260105	CALIPER MOUNT. BRACKET	34 21 6 768 462 , 34 21 6 757 246	11.0230-0162.2
	Cooper S JCW	3) Coull	11.2003	08.2008	11.8170-0584.1	260105	CALIPER MOUNT. BRACKET	34 21 6 768 462 , 34 21 6 757 246	11.0230-0162.2



					<b>Bezeichnung</b>	<b>OE-Nummern zu ATE Artikelnummern</b>	<b>i</b> z.B. Vorsachnummern / diverse
--	--	--	--	--	--------------------	---	---

## MINI

R52 Cabrio (04-08)	One	3) Coull	04.2004	08.2008	11.8170-0584.1	260105	CALIPER MOUNT. BRACKET	34 21 6 768 462 , 34 21 6 757 246	11.0230-0162.2
--------------------	-----	----------	---------	---------	----------------	--------	------------------------	-----------------------------------	----------------

## NISSAN

CABSTAR E (F24E) (06-13)	2,5 TDiC	3) Coull	09.2006	12.2013	13.0460-4866.2	604866	BELAGSATZ	74 85 116 333 , 50 01 868 606 , D1060-MB60A , D1060-MB600 , D1060-MB200	s. Abb.
	3,0 TDiC	3) Coull	09.2006	12.2013	13.0460-4866.2	604866	BELAGSATZ	74 85 116 333 , 50 01 868 606 , D1060-MB60A , D1060-MB600 , D1060-MB200	s. Abb.

## OPEL

OMEGA B / Vauxhall Omega (94-03)	2	3) Coull		09.1999	24.2125-1740.3	010971	TANDEM MASTER CYLINDE	93172592 , 5 58 117	
	2,0 16V	3) Coull		09.1999	24.2125-1740.3	010971	TANDEM MASTER CYLINDE	93172592 , 5 58 117	
	2,0 DTI 16V	3) Coull	09.1997	08.2000	24.2125-1740.3	010971	TANDEM MASTER CYLINDE	93172592 , 5 58 117	
	2,2 16V	3) Coull	10.1999	08.2003	24.2125-1740.3	010971	TANDEM MASTER CYLINDE	93172592 , 5 58 117	
	2,2 DTI 16V	3) Coull	09.2000	08.2003	24.2125-1740.3	010971	TANDEM MASTER CYLINDE	93172592 , 5 58 117	
	2,5 DTI	3) Coull	09.2001	08.2003	24.2125-1740.3	010971	TANDEM MASTER CYLINDE	93172592 , 5 58 117	
	2,5 TD	3) Coull		08.2003	24.2125-1740.3	010971	TANDEM MASTER CYLINDE	93172592 , 5 58 117	
	2,5 V6	3) Coull		09.2000	24.2125-1740.3	010971	TANDEM MASTER CYLINDE	93172592 , 5 58 117	
	2,6 V6	3) Coull	09.2000	08.2003	24.2125-1740.3	010971	TANDEM MASTER CYLINDE	93172592 , 5 58 117	
	3,0 V6	3) Coull		01.2001	24.2125-1740.3	010971	TANDEM MASTER CYLINDE	93172592 , 5 58 117	
	3,2 V6	3) Coull	02.2001	08.2003	24.2125-1740.3	010971	TANDEM MASTER CYLINDE	93172592 , 5 58 117	



Bezeichnung

OE-Nummern  
zu ATE  
Artikelnummern



z.B. Vorsachnummern /  
diverse

## PEUGEOT

208 (12-)	1,0 VTi	3) Coull	01.2012		03.0520-9720.3	699720	ATE TOPKIT	16 071 390 80	
	1,2 THP	3) Coull	01.2013		03.0520-9720.3	699720	ATE TOPKIT	16 071 390 80	
	1,2 VTi	3) Coull	01.2012		03.0520-9720.3	699720	ATE TOPKIT	16 071 390 80	
	1,4 HDi	3) Coull	01.2012		03.0520-9720.3	699720	ATE TOPKIT	16 071 390 80	
	1,4 VTi	3) Coull	01.2012		03.0520-9720.3	699720	ATE TOPKIT	16 071 390 80	
	1,6 BlueHDi 100	3) Coull	01.2015		03.0520-9720.3	699720	ATE TOPKIT	16 071 390 80	
	1,6 BlueHDi 120	3) Coull	11.2013		03.0520-9720.3	699720	ATE TOPKIT	16 071 390 80	
	1,6 e-HDi	3) Coull	01.2012		03.0520-9720.3	699720	ATE TOPKIT	16 071 390 80	
	1,6 HDi	3) Coull	01.2013		03.0520-9720.3	699720	ATE TOPKIT	16 071 390 80	
	1,6 THP	3) Coull	01.2012		03.0520-9720.3	699720	ATE TOPKIT	16 071 390 80	
	1,6 THP 163	3) Coull	03.2015		03.0520-9720.3	699720	ATE TOPKIT	16 071 390 80	
	1,6 VTi	3) Coull	01.2012		03.0520-9720.3	699720	ATE TOPKIT	16 071 390 80	
3008 (09-)	1,2	3) Coull	01.2015		03.7860-3732.4	300306	BREMSEGERAET T5x	16 112 440 80 , 4535 CF	
	1,6 HDi	3) Coull			03.7860-3732.4	300306	BREMSEGERAET T5x	16 112 440 80 , 4535 CF	
		3) Coull	08.2010		03.7860-3732.4	300306	BREMSEGERAET T5x	16 112 440 80 , 4535 CF	
		3) Coull	06.2009		03.7860-3732.4	300306	BREMSEGERAET T5x	16 112 440 80 , 4535 CF	
	1,6 HDi 115	3) Coull	11.2012		03.7860-3732.4	300306	BREMSEGERAET T5x	16 112 440 80 , 4535 CF	
	1,6 HDi 120	3) Coull	05.2014		03.7860-3732.4	300306	BREMSEGERAET T5x	16 112 440 80 , 4535 CF	
	1,6 THP	3) Coull	06.2009		03.7860-3732.4	300306	BREMSEGERAET T5x	16 112 440 80 , 4535 CF	
	1,6 VTi	3) Coull	06.2009		03.7860-3732.4	300306	BREMSEGERAET T5x	16 112 440 80 , 4535 CF	
	2,0 HDi	3) Coull	06.2009		03.7860-3732.4	300306	BREMSEGERAET T5x	16 112 440 80 , 4535 CF	



					<b>Bezeichnung</b>	<b>OE-Nummern zu ATE Artikelnummern</b>	 <b>z.B. Vorsachnummern / diverse</b>
--	--	--	--	--	--------------------	---	--

## PEUGEOT

3008 (09-)	2,0 HDi	3) Coull	09.2011		03.7860-3732.4	300306	BREMSEGERAET T5x	16 112 440 80 , 4535 CF	
301 (12-)	1,2 VTi 72	3) Coull	11.2012		03.0520-9720.3	699720	ATE TOPKIT	16 071 390 80	
	1,6 HDi 92	3) Coull	11.2012		03.0520-9720.3	699720	ATE TOPKIT	16 071 390 80	
	1,6 VTi 115	3) Coull	11.2012		03.0520-9720.3	699720	ATE TOPKIT	16 071 390 80	
308 II (T9) (13-)	1,2 THP 110	3) Coull	11.2013		13.0460-7300.2	607300	BELAGSATZ	16 124 123 80 , 16 098 985 80	s. Abb.
	1,2 THP 130	3) Coull	11.2013		13.0460-7300.2	607300	BELAGSATZ	16 124 123 80 , 16 098 985 80	s. Abb.
	1,2 VTi 82	3) Coull	09.2013		13.0460-7300.2	607300	BELAGSATZ	16 124 123 80 , 16 098 985 80	s. Abb.
	1,6 GT 205	3) Coull	06.2014		13.0460-7300.2	607300	BELAGSATZ	16 124 123 80 , 16 098 985 80	s. Abb.
	1,6 HDi 100	3) Coull	04.2014		13.0460-7300.2	607300	BELAGSATZ	16 124 123 80 , 16 098 985 80	s. Abb.
	1,6 HDi 115	3) Coull	09.2013		13.0460-7300.2	607300	BELAGSATZ	16 124 123 80 , 16 098 985 80	s. Abb.
	1,6 HDi 120	3) Coull	11.2013		13.0460-7300.2	607300	BELAGSATZ	16 124 123 80 , 16 098 985 80	s. Abb.
	1,6 HDi 92	3) Coull	09.2013		13.0460-7300.2	607300	BELAGSATZ	16 124 123 80 , 16 098 985 80	s. Abb.
	1,6 THP 125	3) Coull	09.2013		13.0460-7300.2	607300	BELAGSATZ	16 124 123 80 , 16 098 985 80	s. Abb.
	1,6 THP 150	3) Coull	03.2014		13.0460-7300.2	607300	BELAGSATZ	16 124 123 80 , 16 098 985 80	s. Abb.
	1,6 THP 155	3) Coull	09.2013		13.0460-7300.2	607300	BELAGSATZ	16 124 123 80 , 16 098 985 80	s. Abb.
	1,6 THP 163	3) Coull	06.2014		13.0460-7300.2	607300	BELAGSATZ	16 124 123 80 , 16 098 985 80	s. Abb.



					<b>Bezeichnung</b>	<b>OE-Nummern zu ATE Artikelnummern</b>	 z.B. Vorsachnummern / diverse
--	--	--	--	--	--------------------	---	--------------------------------------

## PEUGEOT

308 II (T9) (13-)	1,6 VTi	3) Coull	03.2014		13.0460-7300.2	607300	BELAGSATZ	16 124 123 80 , 16 098 985 80	s. Abb.
	2,0 GT HDi 180	3) Coull	06.2014		13.0460-7300.2	607300	BELAGSATZ	16 124 123 80 , 16 098 985 80	s. Abb.
	2,0 HDi 150	3) Coull	11.2013		13.0460-7300.2	607300	BELAGSATZ	16 124 123 80 , 16 098 985 80	s. Abb.
308 II SW (14-)	1,2 e-THP	3) Coull	08.2014		13.0460-7300.2	607300	BELAGSATZ	16 124 123 80 , 16 098 985 80	s. Abb.
		3) Coull	03.2014		13.0460-7300.2	607300	BELAGSATZ	16 124 123 80 , 16 098 985 80	s. Abb.
	1,6 BlueHDi	3) Coull	03.2014		13.0460-7300.2	607300	BELAGSATZ	16 124 123 80 , 16 098 985 80	s. Abb.
	1,6 e-HDi	3) Coull	03.2014		13.0460-7300.2	607300	BELAGSATZ	16 124 123 80 , 16 098 985 80	s. Abb.
	1,6 GT 205	3) Coull	06.2014		13.0460-7300.2	607300	BELAGSATZ	16 124 123 80 , 16 098 985 80	s. Abb.
	1,6 HDi	3) Coull	03.2014		13.0460-7300.2	607300	BELAGSATZ	16 124 123 80 , 16 098 985 80	s. Abb.
	1,6 THP	3) Coull	03.2014		13.0460-7300.2	607300	BELAGSATZ	16 124 123 80 , 16 098 985 80	s. Abb.
	1,6 THP 125	3) Coull	03.2014		13.0460-7300.2	607300	BELAGSATZ	16 124 123 80 , 16 098 985 80	s. Abb.
	1,6 THP 150	3) Coull	03.2014		13.0460-7300.2	607300	BELAGSATZ	16 124 123 80 , 16 098 985 80	s. Abb.
	1,6 THP 163	3) Coull	06.2014		13.0460-7300.2	607300	BELAGSATZ	16 124 123 80 , 16 098 985 80	s. Abb.
	1,6 VTi	3) Coull	03.2014		13.0460-7300.2	607300	BELAGSATZ	16 124 123 80 , 16 098 985 80	s. Abb.



	<b>i</b>				<b>Bezeichnung</b>	<b>OE-Nummern zu ATE Artikelnummern</b>	<b>i</b> z.B. Vorsachnummern / diverse
--	----------	--	--	--	--------------------	---	--

## PEUGEOT

308 II SW (14-)	2,0 BlueHDi	3) Coull	03.2014		13.0460-7300.2	607300	BELAGSATZ	16 124 123 80 , 16 098 985 80	s. Abb.
	2,0 BlueHDi 180	3) Coull	06.2014		13.0460-7300.2	607300	BELAGSATZ	16 124 123 80 , 16 098 985 80	s. Abb.
	2,0 GT HDi 180	3) Coull	06.2014		13.0460-7300.2	607300	BELAGSATZ	16 124 123 80 , 16 098 985 80	s. Abb.
5008 (09-)	1,2	3) Coull	01.2015		03.7860-3732.4	300306	BREMSEGERAET T5x	16 112 440 80 , 4535 CF	
	1,6 16V	3) Coull	09.2009		03.7860-3732.4	300306	BREMSEGERAET T5x	16 112 440 80 , 4535 CF	
	1,6 HDi	3) Coull			03.7860-3732.4	300306	BREMSEGERAET T5x	16 112 440 80 , 4535 CF	
		3) Coull	09.2009		03.7860-3732.4	300306	BREMSEGERAET T5x	16 112 440 80 , 4535 CF	
		3) Coull	08.2010		03.7860-3732.4	300306	BREMSEGERAET T5x	16 112 440 80 , 4535 CF	
	1,6 HDi 115	3) Coull	11.2012		03.7860-3732.4	300306	BREMSEGERAET T5x	16 112 440 80 , 4535 CF	
	1,6 HDi 120	3) Coull	05.2014		03.7860-3732.4	300306	BREMSEGERAET T5x	16 112 440 80 , 4535 CF	
	1,6 THP 150	3) Coull	02.2012		03.7860-3732.4	300306	BREMSEGERAET T5x	16 112 440 80 , 4535 CF	
	1,6 THP 163	3) Coull	02.2012		03.7860-3732.4	300306	BREMSEGERAET T5x	16 112 440 80 , 4535 CF	
	2,0 HDi	3) Coull	09.2009		03.7860-3732.4	300306	BREMSEGERAET T5x	16 112 440 80 , 4535 CF	
		3) Coull	02.2012		03.7860-3732.4	300306	BREMSEGERAET T5x	16 112 440 80 , 4535 CF	
508 (10-)	1,6 HDi	HR	11.2010		11.9387-7090.2	220998	FAUSTSATTEL	16 109 007 80 , 4401 R9 , 4401 S1	
		HR	02.2012		11.9387-7090.2	220998	FAUSTSATTEL	16 109 007 80 , 4401 R9 , 4401 S1	
		HL	02.2012		11.9387-7089.2	220997	FAUSTSATTEL	16 109 006 80 , 4401 R8 , 4401 S0	
		HL	11.2010		11.9387-7089.2	220997	FAUSTSATTEL	16 109 006 80 , 4401 R8 , 4401 S0	





	<b>i</b>				<b>Bezeichnung</b>	<b>OE-Nummern zu ATE Artikelnummern</b>	<b>i</b> z.B. Vorsachnummern / diverse
--	----------	--	--	--	--------------------	---	--

## PEUGEOT

508 (10-)	1,6 THP	HR	11.2010		11.9387-7090.2	220998	FAUSTSATTEL	16 109 007 80 , 4401 R9 , 4401 S1
		HL	11.2010		11.9387-7089.2	220997	FAUSTSATTEL	16 109 006 80 , 4401 R8 , 4401 S0
	1,6 VTi	HR	11.2010		11.9387-7090.2	220998	FAUSTSATTEL	16 109 007 80 , 4401 R9 , 4401 S1
		HL	11.2010		11.9387-7089.2	220997	FAUSTSATTEL	16 109 006 80 , 4401 R8 , 4401 S0
	2,0 HDi	HR	11.2010		11.9387-7090.2	220998	FAUSTSATTEL	16 109 007 80 , 4401 R9 , 4401 S1
		HL	11.2010		11.9387-7089.2	220997	FAUSTSATTEL	16 109 006 80 , 4401 R8 , 4401 S0
	2,0 HDi 150	HR	04.2014		11.9387-7090.2	220998	FAUSTSATTEL	16 109 007 80 , 4401 R9 , 4401 S1
		HL	04.2014		11.9387-7089.2	220997	FAUSTSATTEL	16 109 006 80 , 4401 R8 , 4401 S0
	2,0 HDi 180	HR	04.2014		11.9387-7090.2	220998	FAUSTSATTEL	16 109 007 80 , 4401 R9 , 4401 S1
		HL	04.2014		11.9387-7089.2	220997	FAUSTSATTEL	16 109 006 80 , 4401 R8 , 4401 S0
	2,0 HDi Hybrid4	HR	06.2012		11.9387-7090.2	220998	FAUSTSATTEL	16 109 007 80 , 4401 R9 , 4401 S1
		HL	06.2012		11.9387-7089.2	220997	FAUSTSATTEL	16 109 006 80 , 4401 R8 , 4401 S0
	2,0 HDi Hybrid4 AWC	HR	11.2010		11.9387-7090.2	220998	FAUSTSATTEL	16 109 007 80 , 4401 R9 , 4401 S1
		HL	11.2010		11.9387-7089.2	220997	FAUSTSATTEL	16 109 006 80 , 4401 R8 , 4401 S0







	<b>i</b>				<b>Bezeichnung</b>	<b>OE-Nummern zu ATE Artikelnummern</b>	<b>i</b> z.B. Vorsachnummern / diverse
--	----------	--	--	--	--------------------	---	--

## PEUGEOT

508 (10-)	2,2 HDi	HR	11.2010		11.9387-7090.2	220998	FAUSTSATTEL	16 109 007 80 , 4401 R9 , 4401 S1
		HL	11.2010		11.9387-7089.2	220997	FAUSTSATTEL	16 109 006 80 , 4401 R8 , 4401 S0
508 SW (10-)	1,6 HDi	HR	02.2012		11.9387-7090.2	220998	FAUSTSATTEL	16 109 007 80 , 4401 R9 , 4401 S1
		HL	11.2010		11.9387-7089.2	220997	FAUSTSATTEL	16 109 006 80 , 4401 R8 , 4401 S0
		HL	02.2012		11.9387-7089.2	220997	FAUSTSATTEL	16 109 006 80 , 4401 R8 , 4401 S0
		HR	11.2010		11.9387-7090.2	220998	FAUSTSATTEL	16 109 007 80 , 4401 R9 , 4401 S1
	1,6 THP	HR	11.2010		11.9387-7090.2	220998	FAUSTSATTEL	16 109 007 80 , 4401 R9 , 4401 S1
		HL	11.2010		11.9387-7089.2	220997	FAUSTSATTEL	16 109 006 80 , 4401 R8 , 4401 S0
		HL	02.2012		11.9387-7089.2	220997	FAUSTSATTEL	16 109 006 80 , 4401 R8 , 4401 S0
		HR	02.2012		11.9387-7090.2	220998	FAUSTSATTEL	16 109 007 80 , 4401 R9 , 4401 S1
	1,6 VTi	HR	11.2010		11.9387-7090.2	220998	FAUSTSATTEL	16 109 007 80 , 4401 R9 , 4401 S1
		HL	11.2010		11.9387-7089.2	220997	FAUSTSATTEL	16 109 006 80 , 4401 R8 , 4401 S0
	2,0 HDi	HR	11.2010		11.9387-7090.2	220998	FAUSTSATTEL	16 109 007 80 , 4401 R9 , 4401 S1
		HL	11.2010		11.9387-7089.2	220997	FAUSTSATTEL	16 109 006 80 , 4401 R8 , 4401 S0



				<b>Bezeichnung</b>	<b>OE-Nummern zu ATE Artikelnummern</b>	 z.B. Vorsachnummern / diverse
---	---	--	---	--------------------	---	---

## PEUGEOT

508 SW (10-)	2,0 HDi 150	HR	04.2014		11.9387-7090.2	220998	FAUSTSATTEL	16 109 007 80 , 4401 R9 , 4401 S1	
		HL	04.2014		11.9387-7089.2	220997	FAUSTSATTEL	16 109 006 80 , 4401 R8 , 4401 S0	
	2,0 HDi 180	HL	04.2014		11.9387-7089.2	220997	FAUSTSATTEL	16 109 006 80 , 4401 R8 , 4401 S0	
		HR	04.2014		11.9387-7090.2	220998	FAUSTSATTEL	16 109 007 80 , 4401 R9 , 4401 S1	
	2,2 HDi	HR	11.2010		11.9387-7090.2	220998	FAUSTSATTEL	16 109 007 80 , 4401 R9 , 4401 S1	
		HL	11.2010		11.9387-7089.2	220997	FAUSTSATTEL	16 109 006 80 , 4401 R8 , 4401 S0	



					<b>Bezeichnung</b>	<b>OE-Nummern zu ATE Artikelnummern</b>	 z.B. Vorsachnummern / diverse
--	--	--	--	--	--------------------	---	-----------------------------------

## PORSCHE

BOXSTER (981) (12-)	2,7	VL	04.2012		24.0128-0273.1	428273	BREMSSCHEIBE LINKS	981 351 401 01	
		VR	04.2012		24.0128-0260.1	428260	BREMSSCHEIBE RECHTS	981 351 402 01	
CAYMAN (981C) (13-)		VL	03.2013		24.0128-0273.1	428273	BREMSSCHEIBE LINKS	981 351 401 01	
		VR	03.2013		24.0128-0260.1	428260	BREMSSCHEIBE RECHTS	981 351 402 01	
	3,4 GTS	VL	02.2014		24.0128-0273.1	428273	BREMSSCHEIBE LINKS	981 351 401 01	
		VR	02.2014		24.0128-0260.1	428260	BREMSSCHEIBE RECHTS	981 351 402 01	
	3,4 S	VL	03.2013		24.0128-0273.1	428273	BREMSSCHEIBE LINKS	981 351 401 01	
		VR	03.2013		24.0128-0260.1	428260	BREMSSCHEIBE RECHTS	981 351 402 01	
MACAN (13-)	2	3) Coup	07.2014		13.0460-2770.2	602770	BELAGSATZ	4G0 698 451 C , 4G0 698 451 B , 4G0 698 451 A	s. Abb.
	3,0 S	3) Coup	11.2013		13.0460-2770.2	602770	BELAGSATZ	4G0 698 451 C , 4G0 698 451 B , 4G0 698 451 A	s. Abb.
	3,0 S Diesel	3) Coup	11.2013		13.0460-2770.2	602770	BELAGSATZ	4G0 698 451 C , 4G0 698 451 B , 4G0 698 451 A	s. Abb.
	3,6 Turbo	3) Coup	11.2013		13.0460-2770.2	602770	BELAGSATZ	4G0 698 451 C , 4G0 698 451 B , 4G0 698 451 A	s. Abb.



					<b>Bezeichnung</b>	<b>OE-Nummern zu ATE Artikelnummern</b>	 z.B. Vorsachnummern / diverse
--	--	--	--	--	--------------------	---	--------------------------------------

## RENAULT

DUSTER (HS-) (11-)	1,5 dCi	3) Coull	06.2011		03.2122-2261.3	010964	TANDEM MASTER CYLINDE	46 01 199 52R	
	1,5 dCi 4x4	3) Coull	06.2011		03.2122-2261.3	010964	TANDEM MASTER CYLINDE	46 01 199 52R	
	1,6 16V	3) Coull	06.2011		03.2122-2261.3	010964	TANDEM MASTER CYLINDE	46 01 199 52R	
	1,6 16V 4x4	3) Coull	06.2011		03.2122-2261.3	010964	TANDEM MASTER CYLINDE	46 01 199 52R	
	2	3) Coull	02.2012		03.2122-2261.3	010964	TANDEM MASTER CYLINDE	46 01 199 52R	
	2,0 4x4	3) Coull	02.2012		03.2122-2261.3	010964	TANDEM MASTER CYLINDE	46 01 199 52R	
GRAND SCENIC (JM_) (04-09)	2,0 dCi	HL	05.2007	03.2009	24.3387-1727.7	221005	FAUSTSATTEL	77 01 208 261	
		HR	05.2007	03.2009	24.3387-1728.7	221006	FAUSTSATTEL	77 01 208 262	
GRAND SCENIC (JZ_) (09-)	1,2 TCe	3) Coull	03.2012		24.4123-1715.3	010980	TANDEM MASTER CYLINDE	46 01 158 26R	
		3) Coull	03.2013		24.4123-1715.3	010980	TANDEM MASTER CYLINDE	46 01 158 26R	
	1,4 16V	3) Coull	02.2009		24.4123-1715.3	010980	TANDEM MASTER CYLINDE	46 01 158 26R	
	1,5 dCi	3) Coull	11.2010		24.4123-1715.3	010980	TANDEM MASTER CYLINDE	46 01 158 26R	
		3) Coull	04.2009		24.4123-1715.3	010980	TANDEM MASTER CYLINDE	46 01 158 26R	
		3) Coull	02.2009		24.4123-1715.3	010980	TANDEM MASTER CYLINDE	46 01 158 26R	
	1,6 16V	3) Coull	02.2009		24.4123-1715.3	010980	TANDEM MASTER CYLINDE	46 01 158 26R	
	1,6 dCi	3) Coull	04.2011		24.4123-1715.3	010980	TANDEM MASTER CYLINDE	46 01 158 26R	
	1,9 dCi	3) Coull	02.2009		24.4123-1715.3	010980	TANDEM MASTER CYLINDE	46 01 158 26R	
	2,0 16V	3) Coull	02.2009		24.4123-1715.3	010980	TANDEM MASTER CYLINDE	46 01 158 26R	
	2,0 dCi	3) Coull	04.2009		24.4123-1715.3	010980	TANDEM MASTER CYLINDE	46 01 158 26R	
		3) Coull	02.2009		24.4123-1715.3	010980	TANDEM MASTER CYLINDE	46 01 158 26R	
KANGOO Be Bop (KW0_) (09-10)	1,5 dCi	3) Coull	02.2009	12.2010	24.0111-0174.2	411174	BREMSSCHEIBE LAG.&SEN	82 00 381 148	



Bezeichnung

OE-Nummern  
zu ATE  
Artikelnummern



z.B. Vorsachnummern /  
diverse

## RENAULT

Kfz-Verwendung	Motor	3) Coull	06.2009	12.2010	24.0111-0174.2	411174	BREMSSCHEIBE LAG.&SEN	82 00 381 148	
KANGOO Be Bop (KW0_) (09-10)	1,5 dCi	3) Coull	06.2009	12.2010	24.0111-0174.2	411174	BREMSSCHEIBE LAG.&SEN	82 00 381 148	
		3) Coull	09.2010	12.2010	24.0111-0174.2	411174	BREMSSCHEIBE LAG.&SEN	82 00 381 148	
	1,6 16V	3) Coull	02.2009	12.2010	24.0111-0174.2	411174	BREMSSCHEIBE LAG.&SEN	82 00 381 148	
KANGOO Express/Rapid (FW_) (08-)	1,2 TCe 115	3) Coull	05.2013		24.0111-0182.2	411182	BREMSSCHEIBE LAG.&SEN	40 20 240 76R , 43 20 043 27R , 415 420 01 02	
	1,5 dCi	3) Coull	02.2008	10.2011	24.0111-0174.2	411174	BREMSSCHEIBE LAG.&SEN	82 00 381 148	
		3) Coull	11.2011		24.0111-0182.2	411182	BREMSSCHEIBE LAG.&SEN	40 20 240 76R , 43 20 043 27R , 415 420 01 02	
	1,5 dCi 110	3) Coull	11.2011		24.0111-0182.2	411182	BREMSSCHEIBE LAG.&SEN	40 20 240 76R , 43 20 043 27R , 415 420 01 02	
		3) Coull	09.2010	10.2011	24.0111-0174.2	411174	BREMSSCHEIBE LAG.&SEN	82 00 381 148	
		3) Coull	09.2013		24.0111-0182.2	411182	BREMSSCHEIBE LAG.&SEN	40 20 240 76R , 43 20 043 27R , 415 420 01 02	
	1,5 dCi 75	3) Coull	11.2011		24.0111-0182.2	411182	BREMSSCHEIBE LAG.&SEN	40 20 240 76R , 43 20 043 27R , 415 420 01 02	
		3) Coull	09.2010	10.2011	24.0111-0174.2	411174	BREMSSCHEIBE LAG.&SEN	82 00 381 148	
	1,5 dCi 85	3) Coull	11.2011		24.0111-0182.2	411182	BREMSSCHEIBE LAG.&SEN	40 20 240 76R , 43 20 043 27R , 415 420 01 02	
		3) Coull	02.2008	10.2011	24.0111-0174.2	411174	BREMSSCHEIBE LAG.&SEN	82 00 381 148	
	1,5 dCi 90	3) Coull	06.2009	10.2011	24.0111-0174.2	411174	BREMSSCHEIBE LAG.&SEN	82 00 381 148	
		3) Coull	11.2011		24.0111-0182.2	411182	BREMSSCHEIBE LAG.&SEN	40 20 240 76R , 43 20 043 27R , 415 420 01 02	
	1,6	3) Coull	02.2008	10.2011	24.0111-0174.2	411174	BREMSSCHEIBE LAG.&SEN	82 00 381 148	
		3) Coull	11.2011		24.0111-0182.2	411182	BREMSSCHEIBE LAG.&SEN	40 20 240 76R , 43 20 043 27R , 415 420 01 02	



					<b>Bezeichnung</b>	<b>OE-Nummern zu ATE Artikelnummern</b>	 z.B. Vorsachnummern / diverse
--	--	--	--	--	--------------------	---	-----------------------------------

## RENAULT

KANGOO Express/Rapid (FW_) (08-)	1,6 16V	3) Coull	11.2011		24.0111-0182.2	411182	BREMSSCHEIBE LAG.&SEN	40 20 240 76R , 43 20 043 27R , 415 420 01 02	
		3) Coull	02.2008	10.2011	24.0111-0174.2	411174	BREMSSCHEIBE LAG.&SEN	82 00 381 148	
	1,6 16V LPG	3) Coull	02.2008	10.2011	24.0111-0174.2	411174	BREMSSCHEIBE LAG.&SEN	82 00 381 148	
		3) Coull	11.2011		24.0111-0182.2	411182	BREMSSCHEIBE LAG.&SEN	40 20 240 76R , 43 20 043 27R , 415 420 01 02	
	Z,E,	3) Coull	10.2011		24.0111-0182.2	411182	BREMSSCHEIBE LAG.&SEN	40 20 240 76R , 43 20 043 27R , 415 420 01 02	
KANGOO II (KW_) (08-)	1,2 TCe 115	3) Coull	05.2013		24.0111-0182.2	411182	BREMSSCHEIBE LAG.&SEN	40 20 240 76R , 43 20 043 27R , 415 420 01 02	
	1,5 dCi	3) Coull	02.2008	10.2011	24.0111-0174.2	411174	BREMSSCHEIBE LAG.&SEN	82 00 381 148	
		3) Coull	11.2011		24.0111-0182.2	411182	BREMSSCHEIBE LAG.&SEN	40 20 240 76R , 43 20 043 27R , 415 420 01 02	
	1,5 dCi 110	3) Coull	03.2013		24.0111-0182.2	411182	BREMSSCHEIBE LAG.&SEN	40 20 240 76R , 43 20 043 27R , 415 420 01 02	
		3) Coull	11.2011		24.0111-0182.2	411182	BREMSSCHEIBE LAG.&SEN	40 20 240 76R , 43 20 043 27R , 415 420 01 02	
		3) Coull	09.2010	10.2011	24.0111-0174.2	411174	BREMSSCHEIBE LAG.&SEN	82 00 381 148	
	1,5 dCi 75	3) Coull	11.2012		24.0111-0182.2	411182	BREMSSCHEIBE LAG.&SEN	40 20 240 76R , 43 20 043 27R , 415 420 01 02	
	1,5 dCi 90	3) Coull	11.2012		24.0111-0182.2	411182	BREMSSCHEIBE LAG.&SEN	40 20 240 76R , 43 20 043 27R , 415 420 01 02	
	1,6	3) Coull	02.2008	10.2011	24.0111-0174.2	411174	BREMSSCHEIBE LAG.&SEN	82 00 381 148	
		3) Coull	11.2011		24.0111-0182.2	411182	BREMSSCHEIBE LAG.&SEN	40 20 240 76R , 43 20 043 27R , 415 420 01 02	
	1,6 16V	3) Coull	02.2008	10.2011	24.0111-0174.2	411174	BREMSSCHEIBE LAG.&SEN	82 00 381 148	



					<b>Bezeichnung</b>	<b>OE-Nummern zu ATE Artikelnummern</b>	 z.B. Vorsachnummern / diverse
--	--	--	--	--	--------------------	---	-----------------------------------

## RENAULT

KANGOO II (KW_) (08-)	1,6 16V	3) Coull	11.2011		24.0111-0182.2	411182	BREMSSCHEIBE LAG.&SEN	40 20 240 76R , 43 20 043 27R , 415 420 01 02	
	1,6 16V Hi-Flex	3) Coull	11.2011		24.0111-0182.2	411182	BREMSSCHEIBE LAG.&SEN	40 20 240 76R , 43 20 043 27R , 415 420 01 02	
		3) Coull	02.2008	10.2011	24.0111-0174.2	411174	BREMSSCHEIBE LAG.&SEN	82 00 381 148	
LAGUNA III Coupe (DT0/1) (07-)	1,5 dCi	3) Coull	03.2012		24.0111-0181.2	411181	BREMSSCHEIBE LAG.&SEN	40 20 200 05R	
	2,0 16V Turbo	3) Coull	09.2008		24.0111-0181.2	411181	BREMSSCHEIBE LAG.&SEN	40 20 200 05R	
	2,0 16V Turbo GT	3) Coull	03.2008		24.0111-0181.2	411181	BREMSSCHEIBE LAG.&SEN	40 20 200 05R	
	2,0 dCi	3) Coull	09.2008		24.0111-0181.2	411181	BREMSSCHEIBE LAG.&SEN	40 20 200 05R	
		3) Coull	10.2007		24.0111-0181.2	411181	BREMSSCHEIBE LAG.&SEN	40 20 200 05R	
	2,0 dCi GT	3) Coull	03.2008		24.0111-0181.2	411181	BREMSSCHEIBE LAG.&SEN	40 20 200 05R	
	3,0 dCi	3) Coull	01.2012		24.0111-0181.2	411181	BREMSSCHEIBE LAG.&SEN	40 20 200 05R	
		3) Coull	09.2008		24.0111-0181.2	411181	BREMSSCHEIBE LAG.&SEN	40 20 200 05R	
	3,5 V6	3) Coull	09.2008		24.0111-0181.2	411181	BREMSSCHEIBE LAG.&SEN	40 20 200 05R	
MAXITY (SHF/SHT) (06-)	2,5 DXI	3) Coull	12.2006		13.0460-4866.2	604866	BELAGSATZ	74 85 116 333 , 50 01 868 606 , D1060-MB60A , D1060-MB600 , D1060-MB200	s. Abb.
	3,0 DXI	3) Coull	12.2006		13.0460-4866.2	604866	BELAGSATZ	74 85 116 333 , 50 01 868 606 , D1060-MB60A , D1060-MB600 , D1060-MB200	s. Abb.
MEGANE III CC (EZ0_) (10-)	1,2 TCe	3) Coull	04.2013		24.4123-1715.3	010980	TANDEM MASTER CYLINDE	46 01 158 26R	
	1,4 16V	3) Coull	06.2010		24.4123-1715.3	010980	TANDEM MASTER CYLINDE	46 01 158 26R	
	1,5 dCi	3) Coull	06.2010		24.4123-1715.3	010980	TANDEM MASTER CYLINDE	46 01 158 26R	
	1,6 16V	3) Coull	06.2010		24.4123-1715.3	010980	TANDEM MASTER CYLINDE	46 01 158 26R	





					<b>Bezeichnung</b>	<b>OE-Nummern zu ATE Artikelnummern</b>	 z.B. Vorsachnummern / diverse
--	--	--	--	--	--------------------	---	--------------------------------------

## RENAULT

MEGANE III CC (EZ0_) (10-)	1,6 16V Bio-Petrol	3) Coupl	06.2010		24.4123-1715.3	010980	TANDEM MASTER CYLINDE	46 01 158 26R	
	1,6 dCi	3) Coupl	04.2011		24.4123-1715.3	010980	TANDEM MASTER CYLINDE	46 01 158 26R	
	1,9 dCi	3) Coupl	06.2010		24.4123-1715.3	010980	TANDEM MASTER CYLINDE	46 01 158 26R	
	2,0 16V	3) Coupl	06.2010		24.4123-1715.3	010980	TANDEM MASTER CYLINDE	46 01 158 26R	
	2,0 dCi	3) Coupl	06.2010		24.4123-1715.3	010980	TANDEM MASTER CYLINDE	46 01 158 26R	
	2,0 TCe	3) Coupl	06.2010		24.4123-1715.3	010980	TANDEM MASTER CYLINDE	46 01 158 26R	
MEGANE III Coupe (DZ0_) (08-)	1,2 TCe	3) Coupl	01.2013		24.4123-1715.3	010980	TANDEM MASTER CYLINDE	46 01 158 26R	
		3) Coupl	03.2012		24.4123-1715.3	010980	TANDEM MASTER CYLINDE	46 01 158 26R	
	1,4 16V	3) Coupl	04.2009		24.4123-1715.3	010980	TANDEM MASTER CYLINDE	46 01 158 26R	
	1,5 dCi	3) Coupl	11.2008		24.4123-1715.3	010980	TANDEM MASTER CYLINDE	46 01 158 26R	
		3) Coupl	02.2009		24.4123-1715.3	010980	TANDEM MASTER CYLINDE	46 01 158 26R	
	1,6 16V	3) Coupl	11.2008		24.4123-1715.3	010980	TANDEM MASTER CYLINDE	46 01 158 26R	
	1,6 16V Bifuel	3) Coupl	11.2008		24.4123-1715.3	010980	TANDEM MASTER CYLINDE	46 01 158 26R	
	1,6 dCi	3) Coupl	04.2011		24.4123-1715.3	010980	TANDEM MASTER CYLINDE	46 01 158 26R	
	1,9 dCi	3) Coupl	11.2008		24.4123-1715.3	010980	TANDEM MASTER CYLINDE	46 01 158 26R	
	2,0 16V	3) Coupl	05.2009		24.4123-1715.3	010980	TANDEM MASTER CYLINDE	46 01 158 26R	
	2,0 dCi	3) Coupl	07.2012		24.4123-1715.3	010980	TANDEM MASTER CYLINDE	46 01 158 26R	
		3) Coupl	04.2009		24.4123-1715.3	010980	TANDEM MASTER CYLINDE	46 01 158 26R	
	2,0 TCe	3) Coupl	11.2008		24.4123-1715.3	010980	TANDEM MASTER CYLINDE	46 01 158 26R	
	2,0 TCe 250	3) Coupl	05.2009		24.4123-1715.3	010980	TANDEM MASTER CYLINDE	46 01 158 26R	
MEGANE III Grandtour (KZ_) (08-)	1,2 TCe	3) Coupl	01.2013		24.4123-1715.3	010980	TANDEM MASTER CYLINDE	46 01 158 26R	



Bezeichnung

OE-Nummern  
zu ATE  
Artikelnummern



z.B. Vorsachnummern /  
diverse

## RENAULT

MEGANE III Grandtour (KZ_) (08-)	1,2 TCe	3) Cou	03.2012		24.4123-1715.3	010980	TANDEM MASTER CYLINDE	46 01 158 26R	
	1,4 16V	3) Cou	05.2009		24.4123-1715.3	010980	TANDEM MASTER CYLINDE	46 01 158 26R	
	1,5 dCi	3) Cou	05.2009		24.4123-1715.3	010980	TANDEM MASTER CYLINDE	46 01 158 26R	
		3) Cou	08.2009		24.4123-1715.3	010980	TANDEM MASTER CYLINDE	46 01 158 26R	
		3) Cou	02.2009		24.4123-1715.3	010980	TANDEM MASTER CYLINDE	46 01 158 26R	
		3) Cou	11.2013		24.4123-1715.3	010980	TANDEM MASTER CYLINDE	46 01 158 26R	
	1,6 16V	3) Cou	05.2009		24.4123-1715.3	010980	TANDEM MASTER CYLINDE	46 01 158 26R	
	1,6 16V Bifuel	3) Cou	11.2008		24.4123-1715.3	010980	TANDEM MASTER CYLINDE	46 01 158 26R	
	1,6 dCi	3) Cou	04.2011		24.4123-1715.3	010980	TANDEM MASTER CYLINDE	46 01 158 26R	
	1,9 dCi	3) Cou	05.2009		24.4123-1715.3	010980	TANDEM MASTER CYLINDE	46 01 158 26R	
	2,0 16V	3) Cou	05.2009		24.4123-1715.3	010980	TANDEM MASTER CYLINDE	46 01 158 26R	
	2,0 dCi	3) Cou	08.2009		24.4123-1715.3	010980	TANDEM MASTER CYLINDE	46 01 158 26R	
		3) Cou	04.2009		24.4123-1715.3	010980	TANDEM MASTER CYLINDE	46 01 158 26R	
		3) Cou	07.2012		24.4123-1715.3	010980	TANDEM MASTER CYLINDE	46 01 158 26R	
	2,0 TCe	3) Cou	05.2009		24.4123-1715.3	010980	TANDEM MASTER CYLINDE	46 01 158 26R	
		3) Cou	09.2012		24.4123-1715.3	010980	TANDEM MASTER CYLINDE	46 01 158 26R	
MEGANE III Schrögheck (BZO_) (08-)	1,2 TCe	3) Cou	01.2013		24.4123-1715.3	010980	TANDEM MASTER CYLINDE	46 01 158 26R	
		3) Cou	03.2012		24.4123-1715.3	010980	TANDEM MASTER CYLINDE	46 01 158 26R	
	1,4	3) Cou	04.2009		24.4123-1715.3	010980	TANDEM MASTER CYLINDE	46 01 158 26R	
	1,5 dCi	3) Cou	11.2013		24.4123-1715.3	010980	TANDEM MASTER CYLINDE	46 01 158 26R	
		3) Cou	02.2009		24.4123-1715.3	010980	TANDEM MASTER CYLINDE	46 01 158 26R	



Bezeichnung

OE-Nummern  
zu ATE  
Artikelnummern



z.B. Vorsachnummern /  
diverse

## RENAULT

MEGANE III Schrägheck (BZ0_) (08-)	1,5 dCi	3) Cou	12.2009		24.4123-1715.3	010980	TANDEM MASTER CYLINDE	46 01 158 26R	
		3) Cou	11.2008		24.4123-1715.3	010980	TANDEM MASTER CYLINDE	46 01 158 26R	
	1,6	3) Cou	11.2008		24.4123-1715.3	010980	TANDEM MASTER CYLINDE	46 01 158 26R	
	1,6 16V Bifuel	3) Cou	11.2008		24.4123-1715.3	010980	TANDEM MASTER CYLINDE	46 01 158 26R	
	1,6 dCi	3) Cou	04.2011		24.4123-1715.3	010980	TANDEM MASTER CYLINDE	46 01 158 26R	
	1,9 dCi	3) Cou	11.2008		24.4123-1715.3	010980	TANDEM MASTER CYLINDE	46 01 158 26R	
	2	3) Cou	02.2009		24.4123-1715.3	010980	TANDEM MASTER CYLINDE	46 01 158 26R	
	2,0 dCi	3) Cou	07.2012		24.4123-1715.3	010980	TANDEM MASTER CYLINDE	46 01 158 26R	
		3) Cou	10.2010		24.4123-1715.3	010980	TANDEM MASTER CYLINDE	46 01 158 26R	
		3) Cou	04.2009		24.4123-1715.3	010980	TANDEM MASTER CYLINDE	46 01 158 26R	
	2,0 TCe	3) Cou	11.2008		24.4123-1715.3	010980	TANDEM MASTER CYLINDE	46 01 158 26R	
SCENIC II (JM_) (03-09)	1,4 16V	HR	05.2007	03.2009	24.3387-1728.7	221006	FAUSTSATTEL	77 01 208 262	
		HL	05.2007	03.2009	24.3387-1727.7	221005	FAUSTSATTEL	77 01 208 261	
	1,5 dCi	HR	05.2007	03.2009	24.3387-1728.7	221006	FAUSTSATTEL	77 01 208 262	
		HL	05.2007	03.2009	24.3387-1727.7	221005	FAUSTSATTEL	77 01 208 261	
	1,6 16V	HL	05.2007	03.2009	24.3387-1727.7	221005	FAUSTSATTEL	77 01 208 261	
		HR	05.2007	03.2009	24.3387-1728.7	221006	FAUSTSATTEL	77 01 208 262	
	1,9 D	HL	05.2007	03.2009	24.3387-1727.7	221005	FAUSTSATTEL	77 01 208 261	
		HR	05.2007	03.2009	24.3387-1728.7	221006	FAUSTSATTEL	77 01 208 262	
	1,9 dCi	HR	05.2007	03.2009	24.3387-1728.7	221006	FAUSTSATTEL	77 01 208 262	
		HL	05.2007	03.2009	24.3387-1727.7	221005	FAUSTSATTEL	77 01 208 261	



					<b>Bezeichnung</b>	<b>OE-Nummern zu ATE Artikelnummern</b>	 z.B. Vorsachnummern / diverse
--	--	--	--	--	--------------------	---	--------------------------------------

## RENAULT

SCENIC II (JM_) (03-09)	2,0 16V	HR	05.2007	03.2009	24.3387-1728.7	221006	FAUSTSATTEL	77 01 208 262	
		HL	05.2007	03.2009	24.3387-1727.7	221005	FAUSTSATTEL	77 01 208 261	
	2,0 16V Turbo	HL	05.2007	03.2009	24.3387-1727.7	221005	FAUSTSATTEL	77 01 208 261	
		HR	05.2007	03.2009	24.3387-1728.7	221006	FAUSTSATTEL	77 01 208 262	
	2,0 dCi	HL	05.2007	03.2009	24.3387-1727.7	221005	FAUSTSATTEL	77 01 208 261	
		HR	05.2007	03.2009	24.3387-1728.7	221006	FAUSTSATTEL	77 01 208 262	
SCENIC III (JZ_) (09-)	1,2 TCe	3) Coull	03.2012		24.4123-1715.3	010980	TANDEM MASTER CYLINDE	46 01 158 26R	
		3) Coull	03.2013		24.4123-1715.3	010980	TANDEM MASTER CYLINDE	46 01 158 26R	
	1,4 TCe	3) Coull	04.2009		24.4123-1715.3	010980	TANDEM MASTER CYLINDE	46 01 158 26R	
	1,5 dCi	3) Coull	04.2009		24.4123-1715.3	010980	TANDEM MASTER CYLINDE	46 01 158 26R	
		3) Coull	11.2010		24.4123-1715.3	010980	TANDEM MASTER CYLINDE	46 01 158 26R	
	1,6 16V	3) Coull	04.2009		24.4123-1715.3	010980	TANDEM MASTER CYLINDE	46 01 158 26R	
	1,6 dCi	3) Coull	04.2011		24.4123-1715.3	010980	TANDEM MASTER CYLINDE	46 01 158 26R	
	1,6 E85	3) Coull	06.2009		24.4123-1715.3	010980	TANDEM MASTER CYLINDE	46 01 158 26R	
	1,9 dCi	3) Coull	04.2009		24.4123-1715.3	010980	TANDEM MASTER CYLINDE	46 01 158 26R	
	2,0 16V	3) Coull	04.2009		24.4123-1715.3	010980	TANDEM MASTER CYLINDE	46 01 158 26R	
	2,0 dCi	3) Coull	04.2009		24.4123-1715.3	010980	TANDEM MASTER CYLINDE	46 01 158 26R	



	<b>i</b>			<b>Bezeichnung</b>	<b>OE-Nummern zu ATE Artikelnummern</b>	<b>i</b> z.B. Vorsachnummern / diverse
--	----------	--	--	--------------------	---	--

## TOYOTA

AVENSIS (97-03)	1,8 16V (AT221)	3) Coull	09.1997	09.2000	03.7745-4402.4	300295	BREMSGERAET T5x	44610-05120	
	1,8 VVT-i (ZZT221)	3) Coull	10.2000	02.2003	03.7745-4402.4	300295	BREMSGERAET T5x	44610-05120	
	2,0 VVT-i (AZT220)	3) Coull	08.2001	02.2003	03.7745-4402.4	300295	BREMSGERAET T5x	44610-05120	
AYGO (05-14)	1,0 i 12V	LH	07.2005	06.2014	24.3727-1953.2	581953	BRAKE CABLE	46430-0H010	
	1,0 i 12V GPL	LH	07.2005	06.2014	24.3727-1953.2	581953	BRAKE CABLE	46430-0H010	
	1,4 HDi	LH	07.2005	08.2010	24.3727-1953.2	581953	BRAKE CABLE	46430-0H010	
RAV4 II (00-05)	1,8 VVTi	3) Coull	02.2001	07.2003	24.2120-1757.3	010976	TANDEM MASTER CYLINDE	47201-42230	
	2,0 D-4D 4WD	3) Coull	09.2001	07.2003	24.2120-1757.3	010976	TANDEM MASTER CYLINDE	47201-42230	
	2,0 VVTi 4WD	3) Coull	06.2000	07.2003	24.2120-1757.3	010976	TANDEM MASTER CYLINDE	47201-42230	



					<b>Bezeichnung</b>	<b>OE-Nummern zu ATE Artikelnummern</b>	 z.B. Vorsachnummern / diverse
--	--	--	--	--	--------------------	---	--------------------------------------

## VOLKSWAGEN

BEETLE Cabriolet (12-)	1,2 TSI	3) Coupl	11.2012		13.0460-7285.2	607285	BELAGSATZ	5C0 698 151 A	s. Abb.
	1,4 TSI	3) Coupl	12.2014		13.0460-7285.2	607285	BELAGSATZ	5C0 698 151 A	s. Abb.
		3) Coupl	11.2012		13.0460-7285.2	607285	BELAGSATZ	5C0 698 151 A	s. Abb.
	1,6 TDI	3) Coupl	11.2012		13.0460-7285.2	607285	BELAGSATZ	5C0 698 151 A	s. Abb.
	1,8 TSI	3) Coupl	12.2013		13.0460-7285.2	607285	BELAGSATZ	5C0 698 151 A	s. Abb.
	2,0 TDI	3) Coupl	09.2014		13.0460-7285.2	607285	BELAGSATZ	5C0 698 151 A	s. Abb.
		3) Coupl	11.2012		13.0460-7285.2	607285	BELAGSATZ	5C0 698 151 A	s. Abb.
		3) Coupl	12.2014		13.0460-7285.2	607285	BELAGSATZ	5C0 698 151 A	s. Abb.
	2,0 TSI	3) Coupl	11.2012		13.0460-7285.2	607285	BELAGSATZ	5C0 698 151 A	s. Abb.
		3) Coupl	05.2013		13.0460-7285.2	607285	BELAGSATZ	5C0 698 151 A	s. Abb.
		3) Coupl	12.2014		13.0460-7285.2	607285	BELAGSATZ	5C0 698 151 A	s. Abb.
GOLF Plus (05-14)	1,2 TSI	3) Coupl		11.2010	03.7860-8802.4	300291	BREMSEGERAET T5x	1K1 614 106 AC	03.7860-3902.4
	1,4 16V	3) Coupl		11.2010	03.7860-8802.4	300291	BREMSEGERAET T5x	1K1 614 106 AC	03.7860-3902.4
	1,4 FSI	3) Coupl		11.2010	03.7860-8802.4	300291	BREMSEGERAET T5x	1K1 614 106 AC	03.7860-3902.4
	1,4 TSI	3) Coupl		11.2010	03.7860-8802.4	300291	BREMSEGERAET T5x	1K1 614 106 AC	03.7860-3902.4
	1,6	3) Coupl		11.2010	03.7860-8802.4	300291	BREMSEGERAET T5x	1K1 614 106 AC	03.7860-3902.4
	1,6 BiFuel	3) Coupl		11.2010	03.7860-8802.4	300291	BREMSEGERAET T5x	1K1 614 106 AC	03.7860-3902.4
	1,6 FSI	3) Coupl		11.2010	03.7860-8802.4	300291	BREMSEGERAET T5x	1K1 614 106 AC	03.7860-3902.4
	1,6 TDI	3) Coupl		11.2010	03.7860-8802.4	300291	BREMSEGERAET T5x	1K1 614 106 AC	03.7860-3902.4
	1,9 TDI	3) Coupl		11.2010	03.7860-8802.4	300291	BREMSEGERAET T5x	1K1 614 106 AC	03.7860-3902.4
	2,0 FSI	3) Coupl		11.2010	03.7860-8802.4	300291	BREMSEGERAET T5x	1K1 614 106 AC	03.7860-3902.4



					<b>Bezeichnung</b>	<b>OE-Nummern zu ATE Artikelnummern</b>	 z.B. Vorsachnummern / diverse
--	--	--	--	--	--------------------	---	--------------------------------------

## VOLKSWAGEN

GOLF Plus (05-14)	2,0 TDI	3) Coup		11.2010	03.7860-8802.4	300291	BREMSEGERAET T5x	1K1 614 106 AC	03.7860-3902.4
GOLF VI (08-)	1,2 TSI	3) Coup		11.2010	03.7860-8802.4	300291	BREMSEGERAET T5x	1K1 614 106 AC	03.7860-3902.4
	1,4	3) Coup		11.2010	03.7860-8802.4	300291	BREMSEGERAET T5x	1K1 614 106 AC	03.7860-3902.4
	1,4 TSI	3) Coup		11.2010	03.7860-8802.4	300291	BREMSEGERAET T5x	1K1 614 106 AC	03.7860-3902.4
	1,6	3) Coup		11.2010	03.7860-8802.4	300291	BREMSEGERAET T5x	1K1 614 106 AC	03.7860-3902.4
	1,6 BiFuel	3) Coup		11.2010	03.7860-8802.4	300291	BREMSEGERAET T5x	1K1 614 106 AC	03.7860-3902.4
	1,6 TDI	3) Coup		11.2010	03.7860-8802.4	300291	BREMSEGERAET T5x	1K1 614 106 AC	03.7860-3902.4
	1,8 TSI	3) Coup		11.2010	03.7860-8802.4	300291	BREMSEGERAET T5x	1K1 614 106 AC	03.7860-3902.4
	2,0 GTi	3) Coup		11.2010	03.7860-8802.4	300291	BREMSEGERAET T5x	1K1 614 106 AC	03.7860-3902.4
	2,0 R 4motion	3) Coup		11.2010	03.7860-8802.4	300291	BREMSEGERAET T5x	1K1 614 106 AC	03.7860-3902.4
	2,0 TDI	3) Coup		11.2010	03.7860-8802.4	300291	BREMSEGERAET T5x	1K1 614 106 AC	03.7860-3902.4
	2,0 TDI 4motion	3) Coup		11.2010	03.7860-8802.4	300291	BREMSEGERAET T5x	1K1 614 106 AC	03.7860-3902.4
GOLF VI Cabriolet (11-)	1,2 TSI	3) Coup	06.2011		03.7860-8802.4	300291	BREMSEGERAET T5x	1K1 614 106 AC	03.7860-3902.4
	1,4 TSI	3) Coup	06.2011		03.7860-8802.4	300291	BREMSEGERAET T5x	1K1 614 106 AC	03.7860-3902.4
	1,6 TDI	3) Coup	06.2011		03.7860-8802.4	300291	BREMSEGERAET T5x	1K1 614 106 AC	03.7860-3902.4
	2,0 R	3) Coup	01.2013		03.7860-8802.4	300291	BREMSEGERAET T5x	1K1 614 106 AC	03.7860-3902.4
	2,0 TDI	3) Coup	06.2011		03.7860-8802.4	300291	BREMSEGERAET T5x	1K1 614 106 AC	03.7860-3902.4
	2,0 TSI	3) Coup	06.2011		03.7860-8802.4	300291	BREMSEGERAET T5x	1K1 614 106 AC	03.7860-3902.4
JETTA VI (11-)	1,2 TSI	3) Coup	04.2011		13.0460-7285.2	607285	BELAGSATZ	5C0 698 151 A	s. Abb.
	1,4 TSI	3) Coup	04.2011		13.0460-7285.2	607285	BELAGSATZ	5C0 698 151 A	s. Abb.
		3) Coup	08.2014		13.0460-7285.2	607285	BELAGSATZ	5C0 698 151 A	s. Abb.



					<b>Bezeichnung</b>	<b>OE-Nummern zu ATE Artikelnummern</b>	 z.B. Vorsachnummern / diverse
--	--	--	--	--	--------------------	---	--------------------------------------

## VOLKSWAGEN

JETTA VI (11-)	1,4 TSI Hybrid	3) Coupl	04.2011		13.0460-7285.2	607285	BELAGSATZ	5C0 698 151 A	s. Abb.
	1,6	3) Coupl	12.2011		13.0460-7285.2	607285	BELAGSATZ	5C0 698 151 A	s. Abb.
	1,6 TDI	3) Coupl	04.2011		13.0460-7285.2	607285	BELAGSATZ	5C0 698 151 A	s. Abb.
	1,8 TSI	3) Coupl	07.2014		13.0460-7285.2	607285	BELAGSATZ	5C0 698 151 A	s. Abb.
	2,0 TDI	3) Coupl	04.2011		13.0460-7285.2	607285	BELAGSATZ	5C0 698 151 A	s. Abb.
		3) Coupl	08.2014		13.0460-7285.2	607285	BELAGSATZ	5C0 698 151 A	s. Abb.
	2,0 TSI	3) Coupl	12.2012		13.0460-7285.2	607285	BELAGSATZ	5C0 698 151 A	s. Abb.
		3) Coupl	04.2011		13.0460-7285.2	607285	BELAGSATZ	5C0 698 151 A	s. Abb.
SCIROCCO (08-)	1,4 TSI	3) Coupl	11.2013		03.7860-8802.4	300291	BREMSEGERAET T5x	1K1 614 106 AC	03.7860-3902.4
		3) Coupl	09.2008		03.7860-8802.4	300291	BREMSEGERAET T5x	1K1 614 106 AC	03.7860-3902.4
		3) Coupl	08.2008		03.7860-8802.4	300291	BREMSEGERAET T5x	1K1 614 106 AC	03.7860-3902.4
	2,0 R	3) Coupl	08.2014		03.7860-8802.4	300291	BREMSEGERAET T5x	1K1 614 106 AC	03.7860-3902.4
		3) Coupl	11.2009		03.7860-8802.4	300291	BREMSEGERAET T5x	1K1 614 106 AC	03.7860-3902.4
	2,0 TDI	3) Coupl	01.2013		03.7860-8802.4	300291	BREMSEGERAET T5x	1K1 614 106 AC	03.7860-3902.4
		3) Coupl	11.2013		03.7860-8802.4	300291	BREMSEGERAET T5x	1K1 614 106 AC	03.7860-3902.4
		3) Coupl	05.2009		03.7860-8802.4	300291	BREMSEGERAET T5x	1K1 614 106 AC	03.7860-3902.4
		3) Coupl	10.2008		03.7860-8802.4	300291	BREMSEGERAET T5x	1K1 614 106 AC	03.7860-3902.4
	2,0 TSI	3) Coupl	11.2009		03.7860-8802.4	300291	BREMSEGERAET T5x	1K1 614 106 AC	03.7860-3902.4
		3) Coupl	08.2008		03.7860-8802.4	300291	BREMSEGERAET T5x	1K1 614 106 AC	03.7860-3902.4
		3) Coupl	11.2013		03.7860-8802.4	300291	BREMSEGERAET T5x	1K1 614 106 AC	03.7860-3902.4





					<b>Bezeichnung</b>	<b>OE-Nummern zu ATE Artikelnummern</b>	 z.B. Vorsachnummern / diverse
--	--	--	--	--	--------------------	---	--------------------------------------

## VOLKSWAGEN

TRANSPORTER (T5) BUS / MULTIVAN / KASTEN (03-)	1,9 TDI	3) Coull	06.2006		24.5140-0194.3	331383	BREMSSCHLAUCH	7H0 611 776 C , 7H0 611 776 B	
		3) Coull	01.2006		24.5140-0194.3	331383	BREMSSCHLAUCH	7H0 611 776 C , 7H0 611 776 B	
		3) Coull	04.2003		24.5140-0194.3	331383	BREMSSCHLAUCH	7H0 611 776 C , 7H0 611 776 B	
	2	3) Coull	06.2003		24.5140-0194.3	331383	BREMSSCHLAUCH	7H0 611 776 C , 7H0 611 776 B	
	2,0 BiTDI	3) Coull	09.2009		24.5140-0194.3	331383	BREMSSCHLAUCH	7H0 611 776 C , 7H0 611 776 B	
	2,0 BiTDI 4motion	3) Coull	09.2009		24.5140-0194.3	331383	BREMSSCHLAUCH	7H0 611 776 C , 7H0 611 776 B	
	2,0 TDI	3) Coull	05.2010		24.5140-0194.3	331383	BREMSSCHLAUCH	7H0 611 776 C , 7H0 611 776 B	
		3) Coull	05.2011		24.5140-0194.3	331383	BREMSSCHLAUCH	7H0 611 776 C , 7H0 611 776 B	
		3) Coull	09.2009		24.5140-0194.3	331383	BREMSSCHLAUCH	7H0 611 776 C , 7H0 611 776 B	
	2,0 TDI 4motion	3) Coull	05.2010		24.5140-0194.3	331383	BREMSSCHLAUCH	7H0 611 776 C , 7H0 611 776 B	
		3) Coull	09.2009		24.5140-0194.3	331383	BREMSSCHLAUCH	7H0 611 776 C , 7H0 611 776 B	
	2,0 TSI	3) Coull	05.2011		24.5140-0194.3	331383	BREMSSCHLAUCH	7H0 611 776 C , 7H0 611 776 B	
	2,0 TSI 4motion	3) Coull	07.2011		24.5140-0194.3	331383	BREMSSCHLAUCH	7H0 611 776 C , 7H0 611 776 B	
	2,5 TDI	3) Coull	02.2003		24.5140-0194.3	331383	BREMSSCHLAUCH	7H0 611 776 C , 7H0 611 776 B	



	<b>i</b>				<b>Bezeichnung</b>	<b>OE-Nummern zu ATE Artikelnummern</b>	<b>i</b> z.B. Vorsachnummern / diverse
--	----------	--	--	--	--------------------	---	--

## VOLKSWAGEN

TRANSPORTER (T5) BUS / MULTIVAN / KASTEN (03-)	2,5 TDI 4motion	3) Coull	07.2004		24.5140-0194.3	331383	BREMSSCHLAUCH	7H0 611 776 C , 7H0 611 776 B	
	3,2 V6	3) Coull	02.2003		24.5140-0194.3	331383	BREMSSCHLAUCH	7H0 611 776 C , 7H0 611 776 B	
	3,2 V6 4motion	3) Coull	07.2004		24.5140-0194.3	331383	BREMSSCHLAUCH	7H0 611 776 C , 7H0 611 776 B	
TRANSPORTER (T5) PRITSCHEN / FAHRGESTELL (03-)	1,9 TDI	3) Coull	01.2006		24.5140-0194.3	331383	BREMSSCHLAUCH	7H0 611 776 C , 7H0 611 776 B	
		3) Coull	04.2003		24.5140-0194.3	331383	BREMSSCHLAUCH	7H0 611 776 C , 7H0 611 776 B	
		3) Coull	06.2006		24.5140-0194.3	331383	BREMSSCHLAUCH	7H0 611 776 C , 7H0 611 776 B	
	2	3) Coull	06.2003		24.5140-0194.3	331383	BREMSSCHLAUCH	7H0 611 776 C , 7H0 611 776 B	
	2,0 BitDI	3) Coull	09.2009		24.5140-0194.3	331383	BREMSSCHLAUCH	7H0 611 776 C , 7H0 611 776 B	
	2,0 BitDI 4motion	3) Coull	09.2009		24.5140-0194.3	331383	BREMSSCHLAUCH	7H0 611 776 C , 7H0 611 776 B	
	2,0 TDI	3) Coull	09.2009		24.5140-0194.3	331383	BREMSSCHLAUCH	7H0 611 776 C , 7H0 611 776 B	
		3) Coull	05.2010		24.5140-0194.3	331383	BREMSSCHLAUCH	7H0 611 776 C , 7H0 611 776 B	
		3) Coull	05.2011		24.5140-0194.3	331383	BREMSSCHLAUCH	7H0 611 776 C , 7H0 611 776 B	
	2,0 TDI 4motion	3) Coull	05.2010		24.5140-0194.3	331383	BREMSSCHLAUCH	7H0 611 776 C , 7H0 611 776 B	
		3) Coull	09.2009		24.5140-0194.3	331383	BREMSSCHLAUCH	7H0 611 776 C , 7H0 611 776 B	



					<b>Bezeichnung</b>	<b>OE-Nummern zu ATE Artikelnummern</b>	 z.B. Vorsachnummern / diverse
--	--	--	--	--	--------------------	---	--------------------------------------

## VOLKSWAGEN

TRANSPORTER (T5) PRITSCHEN / FAHRGESTELLE (03-)	2,0 TSI	3) Coull	07.2012		24.5140-0194.3	331383	BREMSSCHLAUCH	7H0 611 776 C , 7H0 611 776 B	
	2,5 TDI	3) Coull	02.2003		24.5140-0194.3	331383	BREMSSCHLAUCH	7H0 611 776 C , 7H0 611 776 B	
	2,5 TDI 4motion	3) Coull	07.2004		24.5140-0194.3	331383	BREMSSCHLAUCH	7H0 611 776 C , 7H0 611 776 B	
	3,2 V6	3) Coull	08.2003		24.5140-0194.3	331383	BREMSSCHLAUCH	7H0 611 776 C , 7H0 611 776 B	
		3) Coull	02.2004		24.5140-0194.3	331383	BREMSSCHLAUCH	7H0 611 776 C , 7H0 611 776 B	

**13.0460-2769.2 602769**

**Verwendungen:**

- AUDI A6 (4G2/C7) Limousine (11-)
- AUDI A6 (4G5/C7) Avant (11-)
- AUDI A7 Sportback (10-)

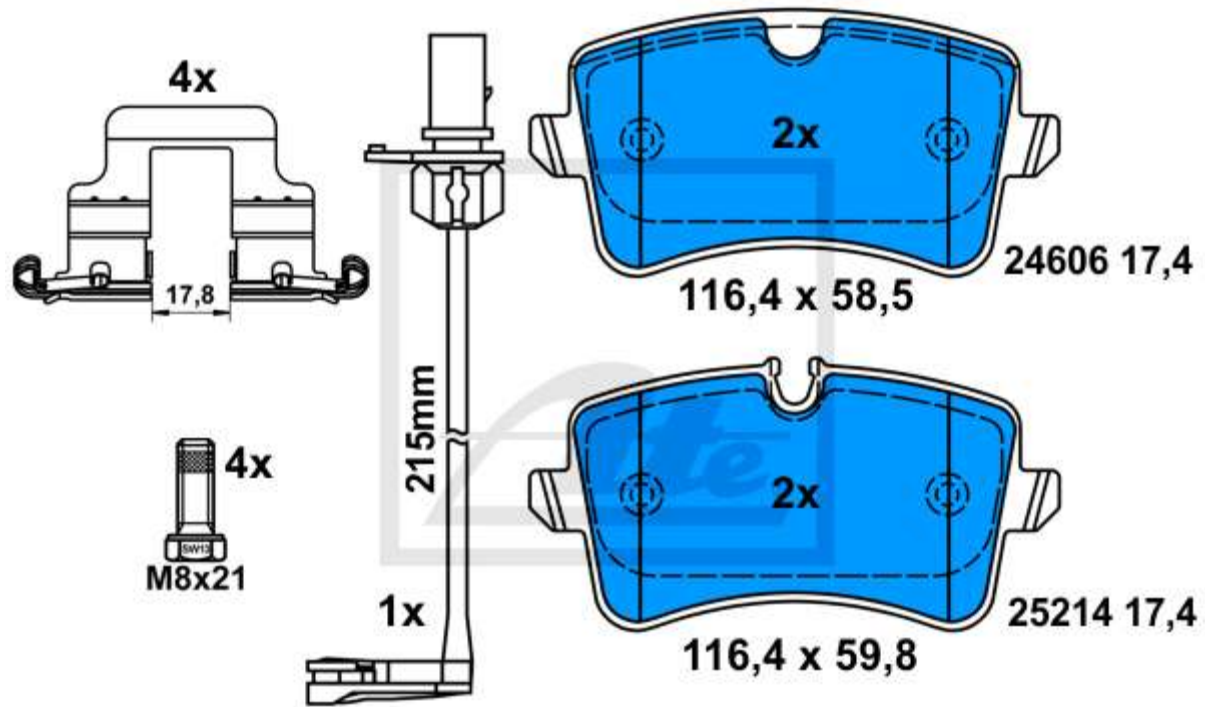

**13.0460-7285.2 607285**

**Verwendungen:**

VOLKSWAGEN BEETLE Cabriolet (12-)  
VOLKSWAGEN JETTA VI (11-)

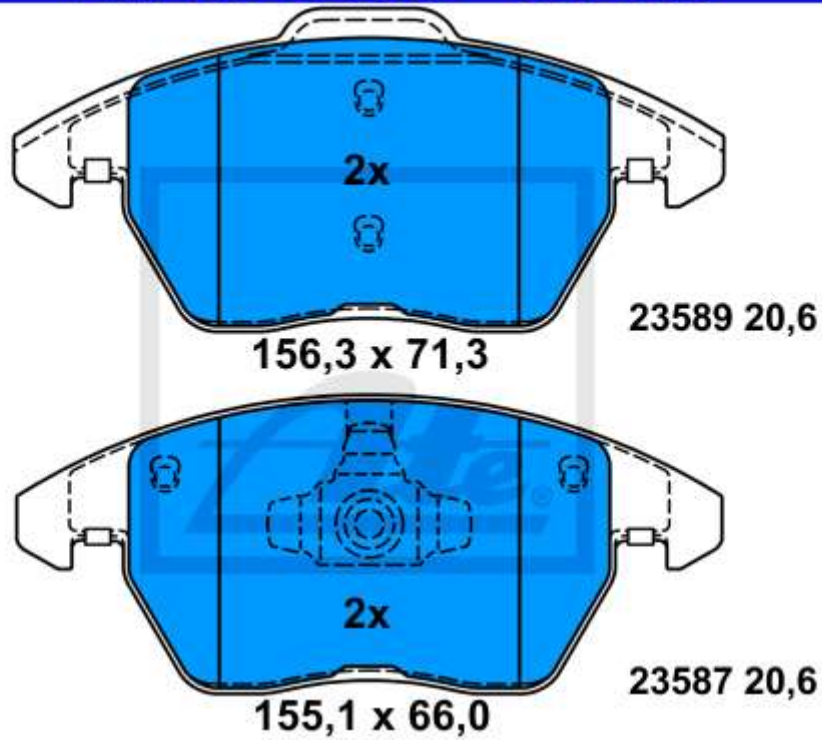

**13.0460-5642.2 605642**

**Verwendungen:**  
CHEVROLET SPARK (10-)

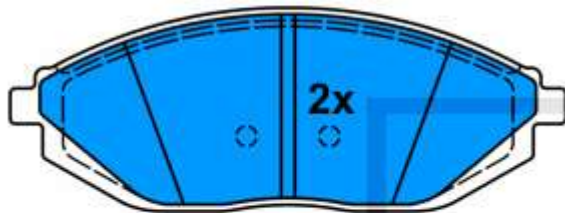

**25268 17,8**

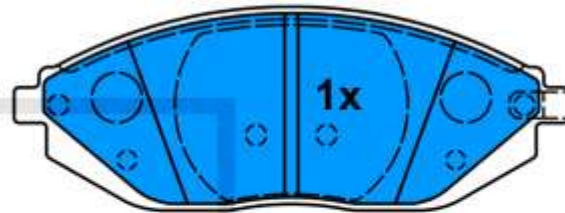

**25269 17,8**

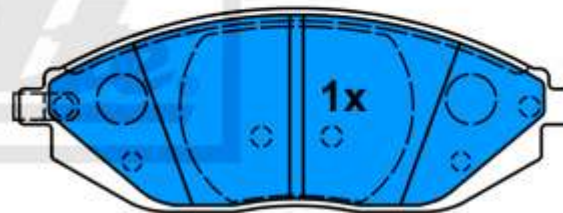

**25270 17,8**

**133,2 x 49,0**

**13.0460-5637.2 605637**

**Verwendungen:**

HYUNDAI H-1 KASTEN (00-07)

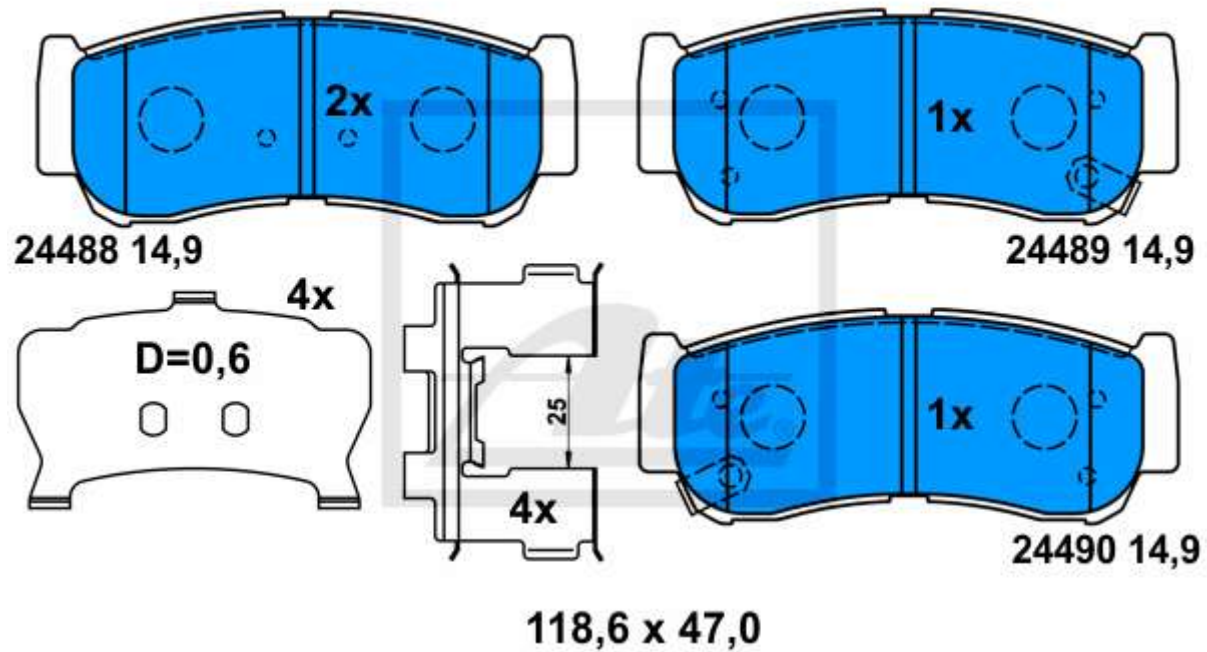

**13.0460-5633.2 605633**

**Verwendungen:**

HYUNDAI GRAND SANTA FE (13-)  
HYUNDAI SANTA FE II (CM) (06-12)  
HYUNDAI SANTA FE III (DM) (12-)  
KIA SORENTO (XM) (09-14)

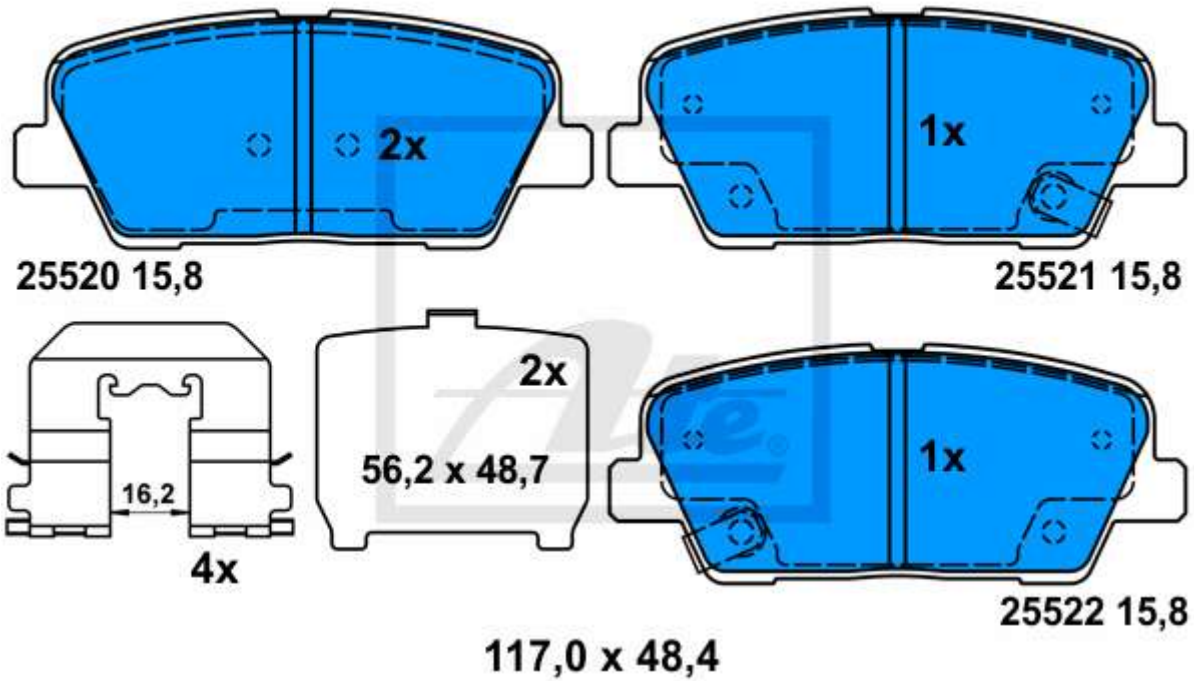



**13.0460-4874.2 604874**

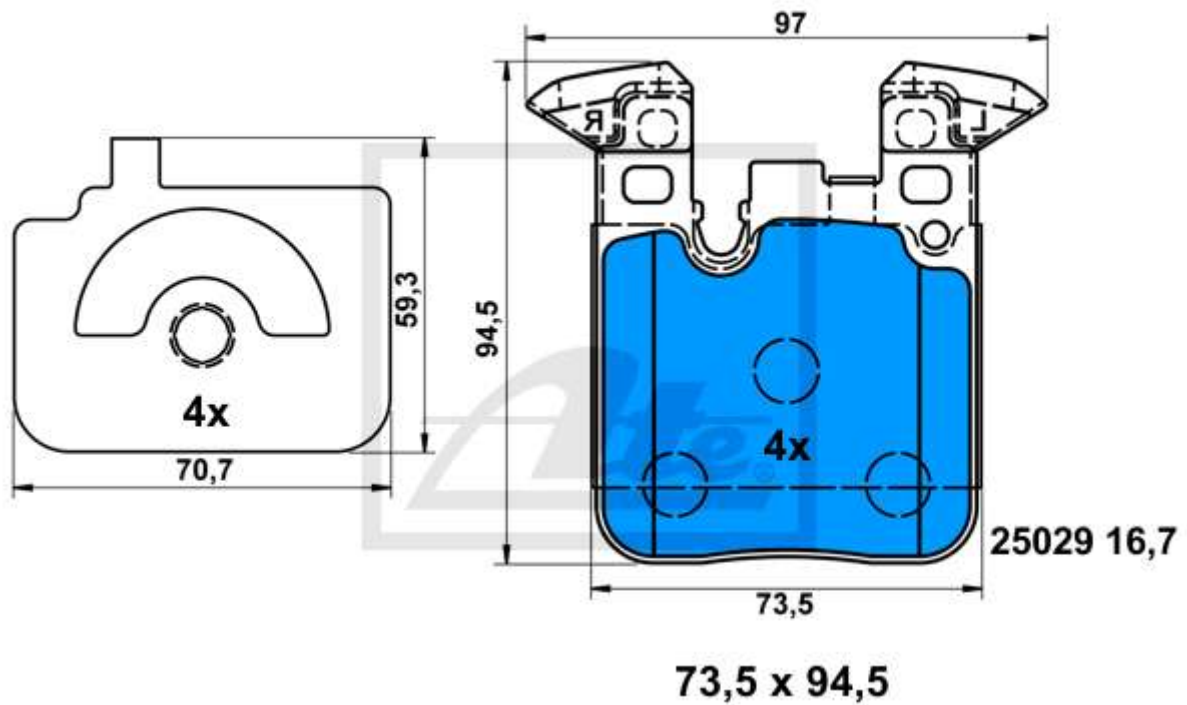

**Verwendungen:**

- BMW 1er Reihe/F20/F21 Limousine (11-)
- BMW 2er Reihe/F22 Coupe (13-)
- BMW 2er Reihe/F23 Cabrio (14-)
- BMW 3er Reihe/F30 Limousine (12-)
- BMW 3er Reihe/F31 Touring (12-)
- BMW 3er Reihe/F34 GT (13-)
- BMW 4er Reihe/F32 Coupe (13-)
- BMW 4er Reihe/F33 Cabrio (14-)
- BMW 4er Reihe/F36 Gran Coupe (14-)

**13.0460-4867.2 604867**

**Verwendungen:**

ALFA ROMEO 159 (05-11)  
ALFA ROMEO BRERA (06-11)  
ALFA ROMEO SPIDER (06-11)

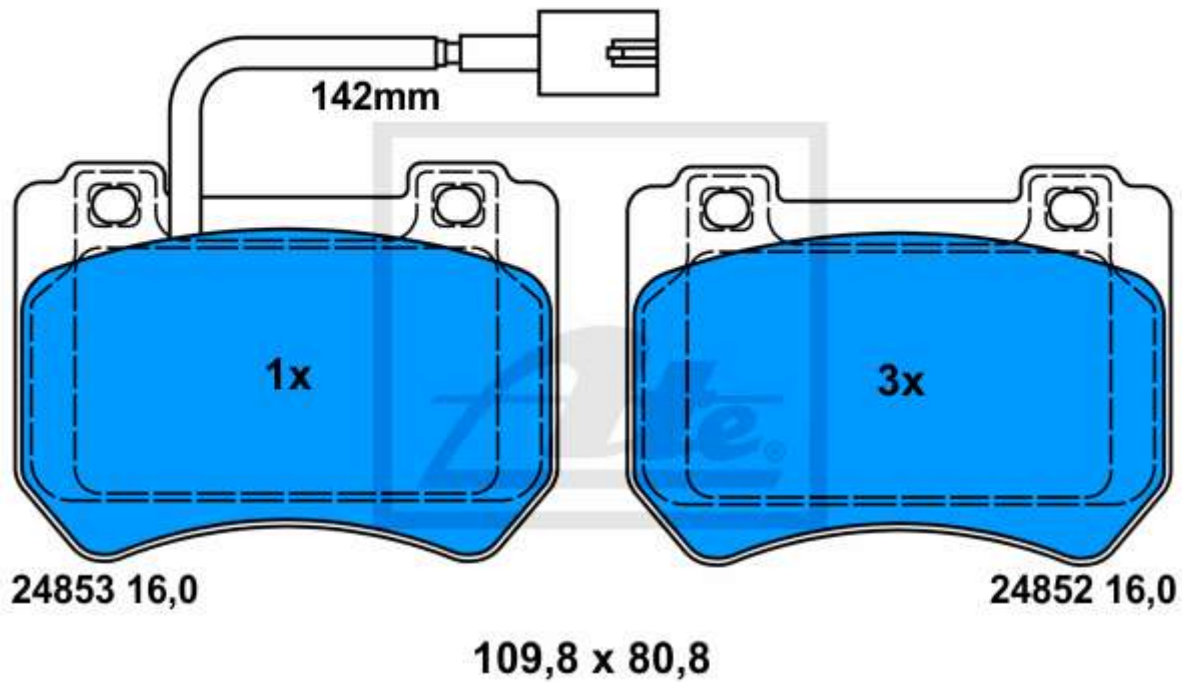

**13.0460-4866.2 604866**

**Verwendungen:**

NISSAN CABSTAR E (F24E) (06-13)  
RENAULT MAXITY (SHF/SHT) (06-)

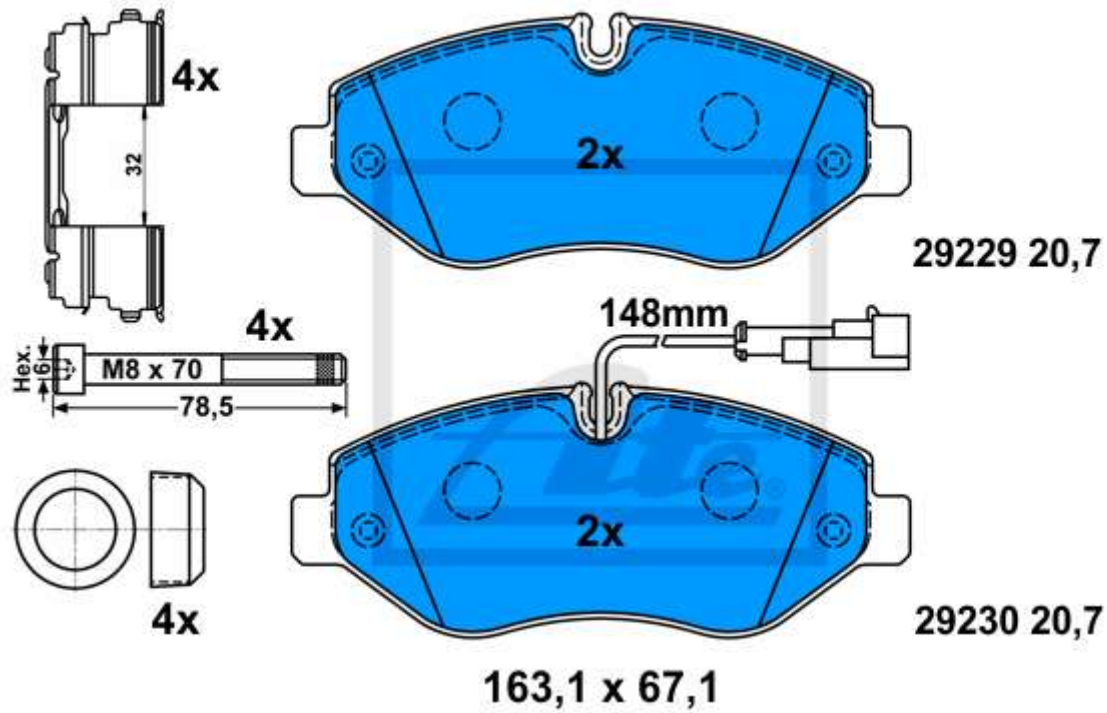

**13.0460-3866.2 603866**

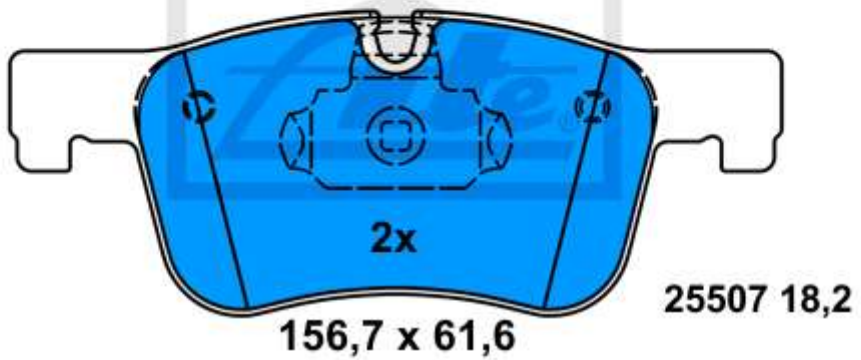
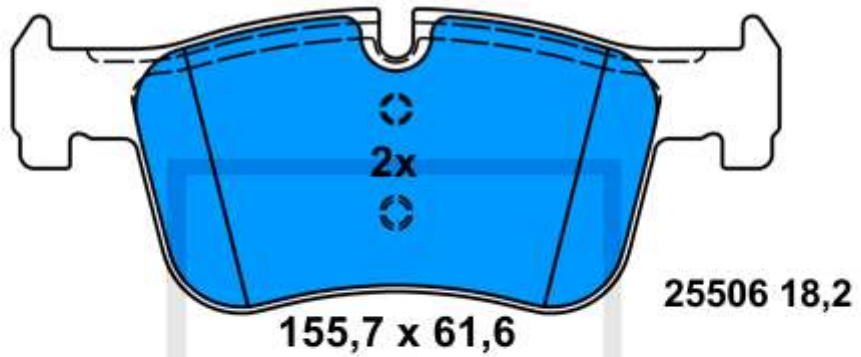

**Verwendungen:**

- BMW 1er Reihe/F20/F21 Limousine (11-)
- BMW 3er Reihe/F30 Limousine (12-)
- BMW 3er Reihe/F31 Touring (12-)
- BMW 3er Reihe/F34 GT (13-)
- BMW 4er Reihe/F32 Coupe (13-)
- BMW 4er Reihe/F33 Cabrio (14-)
- BMW 4er Reihe/F36 Gran Coupe (14-)

**13.0460-2779.2 602779**

**Verwendungen:**

- MERCEDES BENZ A-Klasse (W176 ) (12-)
- MERCEDES BENZ B-Klasse (W246/W242) (11-)
- MERCEDES BENZ CLA-Klasse (C117) Coupe (13-)
- MERCEDES BENZ CLA-Klasse (X117) Shooting Brake (15-)
- MERCEDES BENZ GLA-Klasse (X156) (13-)

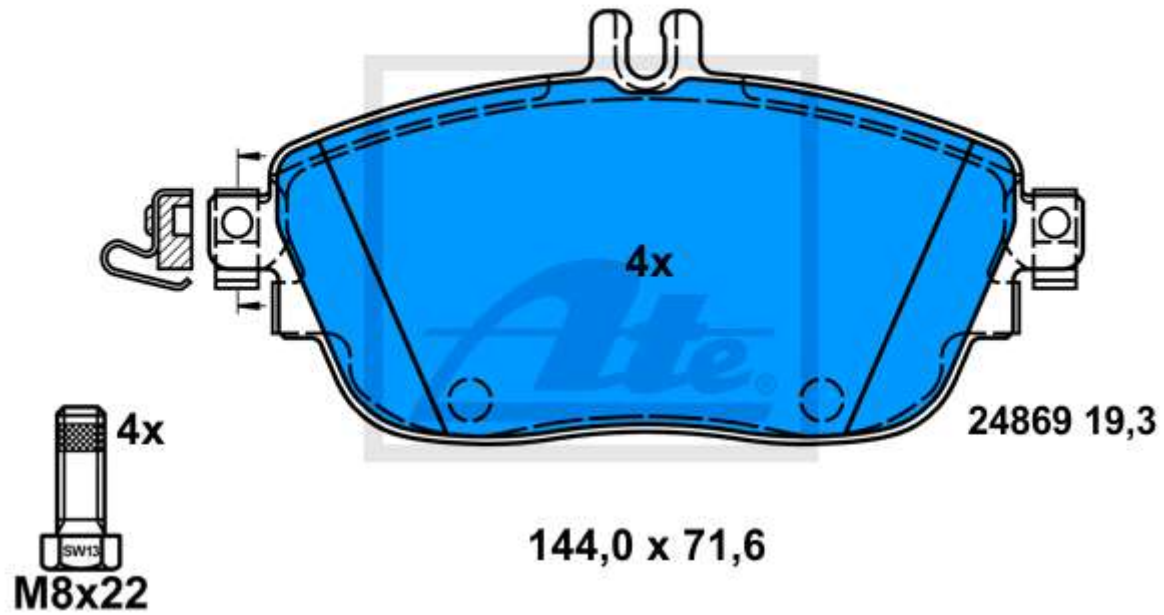

13.0460-2773.2 602773

**Verwendungen:**

AUDI A8 (09-)

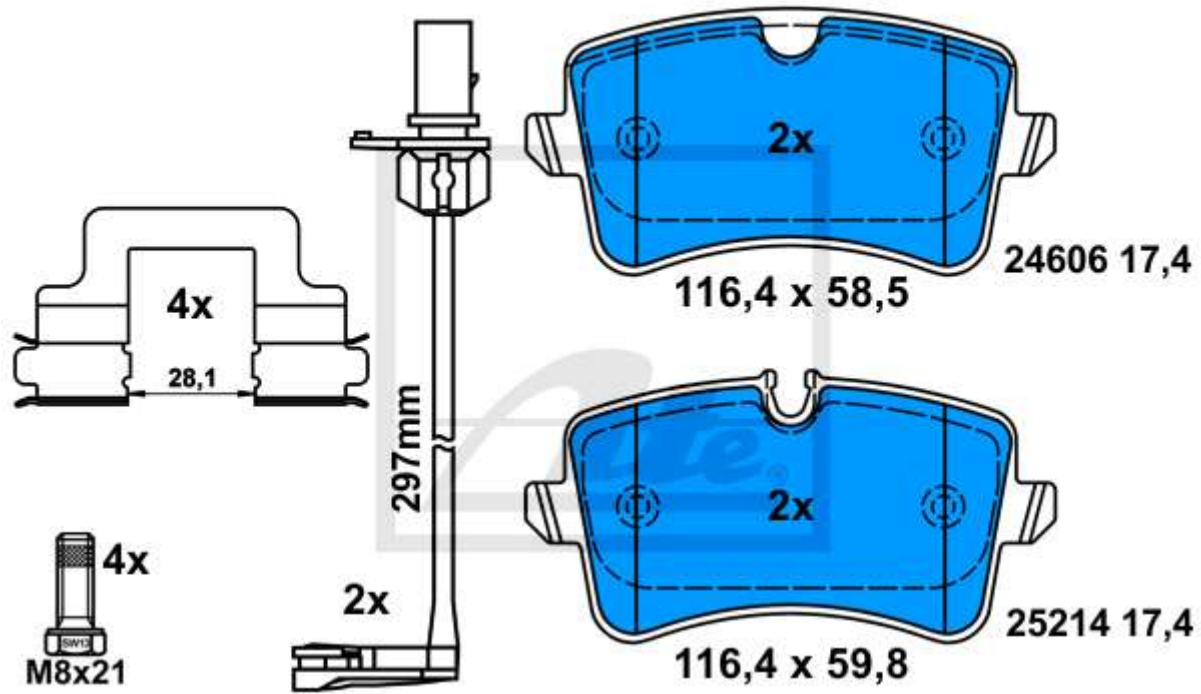

**13.0460-7296.2 607296**

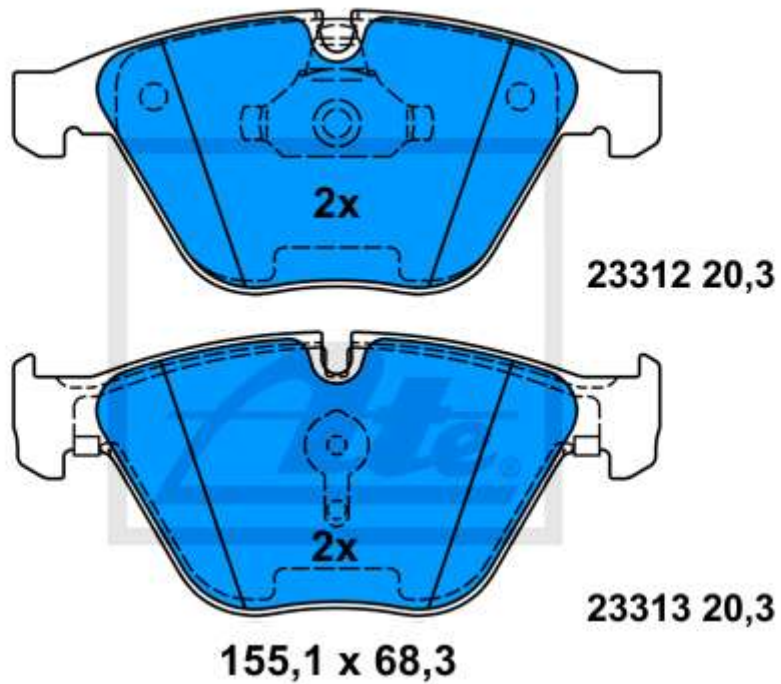

**Verwendungen:**

- BMW 5er Reihe/E60 Limousine (03-10)
- BMW 5er Reihe/E61 Touring (04-10)
- BMW 6er Reihe/E63 Coupe (04-11)
- BMW 6er Reihe/E64 Cabrio (04-11)



**13.0460-2770.2 602770**

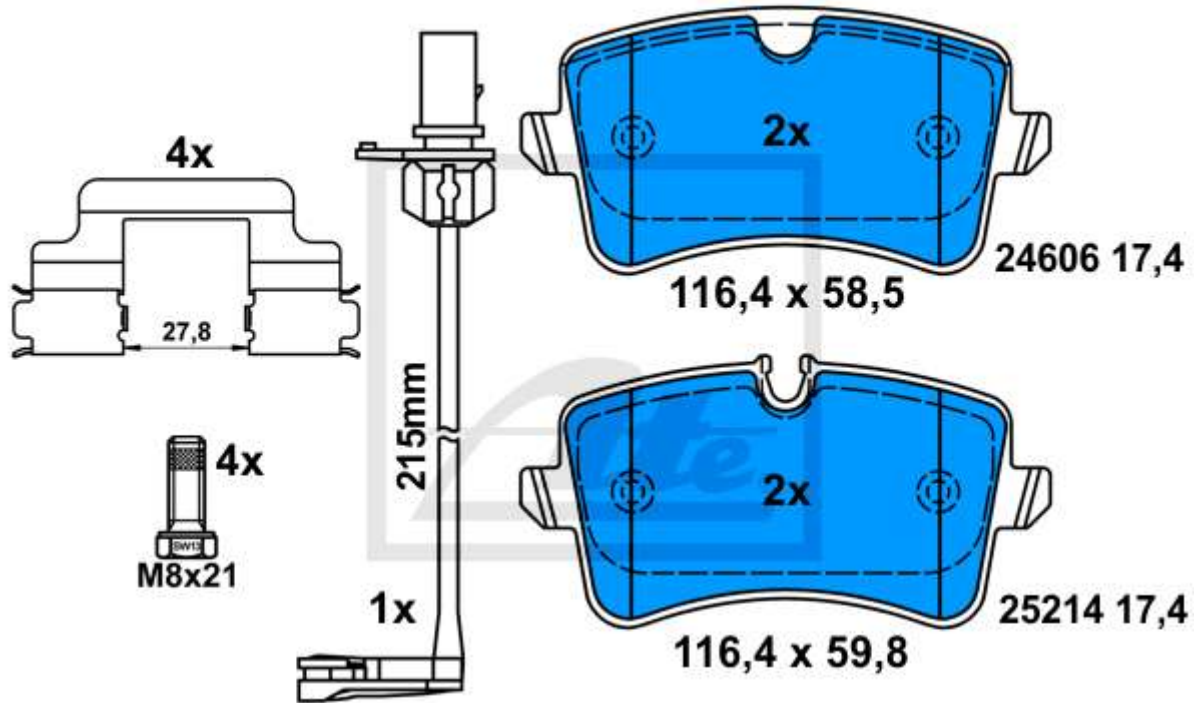

**Verwendungen:**

- AUDI A4 (B8) Avant (08-)
- AUDI A5 Cabrio (09-)
- AUDI A6 (4G2/C7) Limousine (11-)
- AUDI A6 (4G5/C7) Avant (11-)
- AUDI A6 Allroad (12-)
- AUDI A7 Sportback (10-)
- PORSCHE MACAN (13-)



**13.0460-2786.2 602786**

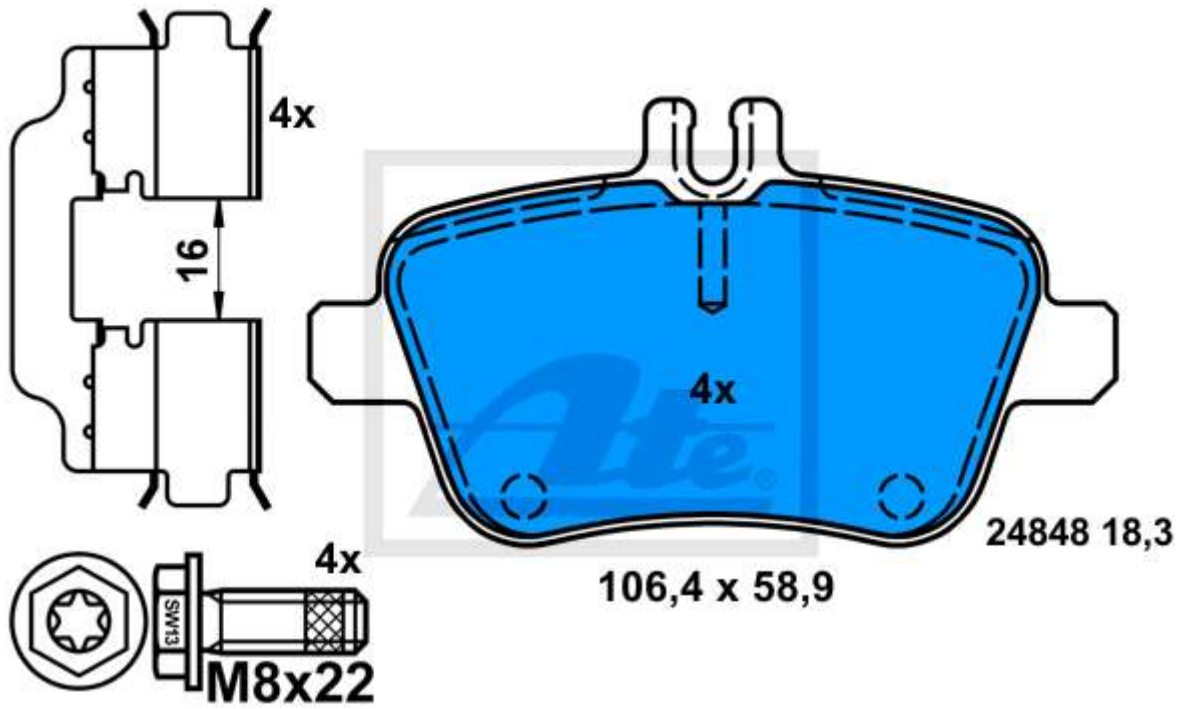

**Verwendungen:**

- MERCEDES BENZ A-Klasse (W176 ) (12-)
- MERCEDES BENZ B-Klasse (W246/W242) (11-)
- MERCEDES BENZ CLA-Klasse (C117) Coupe (13-)
- MERCEDES BENZ CLA-Klasse (X117) Shooting Brake (15-)
- MERCEDES BENZ GLA-Klasse (X156) (13-)
- MERCEDES BENZ SLK-Klasse (R172) (11-)

**13.0460-2772.2 602772**

**Verwendungen:**

KIA VENGA (10-)

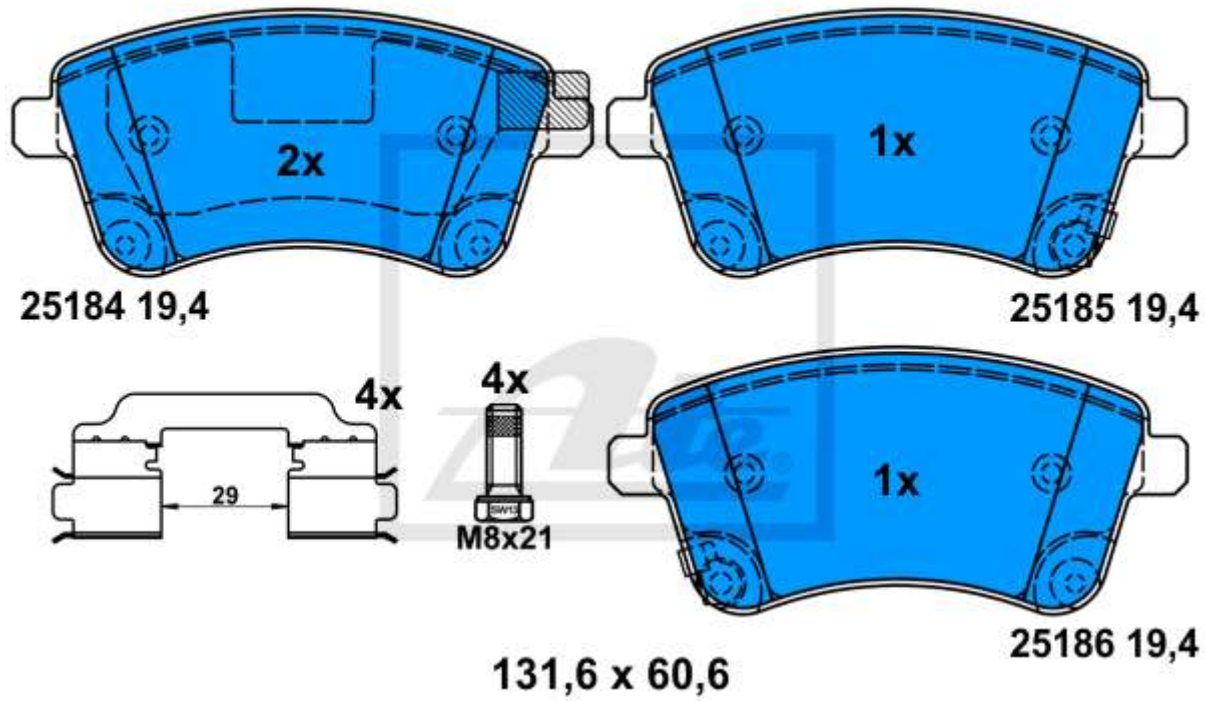

**13.0460-2778.2 602778**

**Verwendungen:**

MERCEDES BENZ A-Klasse (W176 ) (12-)  
MERCEDES BENZ B-Klasse (W246/W242) (11-)

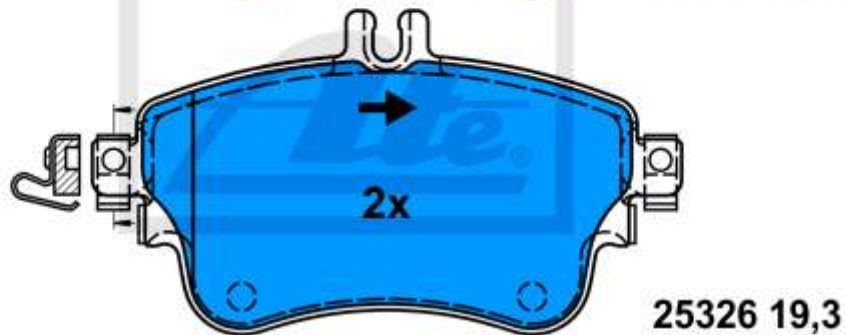
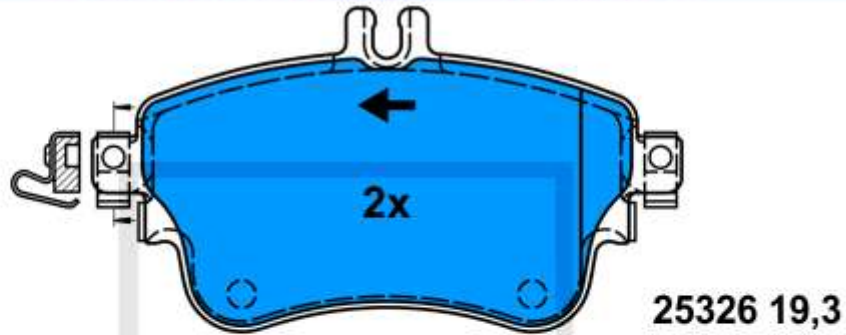

**129,0 x 71,3**

**13.0460-7300.2 607300**

**Verwendungen:**

PEUGEOT 308 II (T9) (13-)  
PEUGEOT 308 II SW (14-)  
CITROEN C4 II GRAND PICASSO (13-)  
CITROEN C4 II PICASSO (13-)

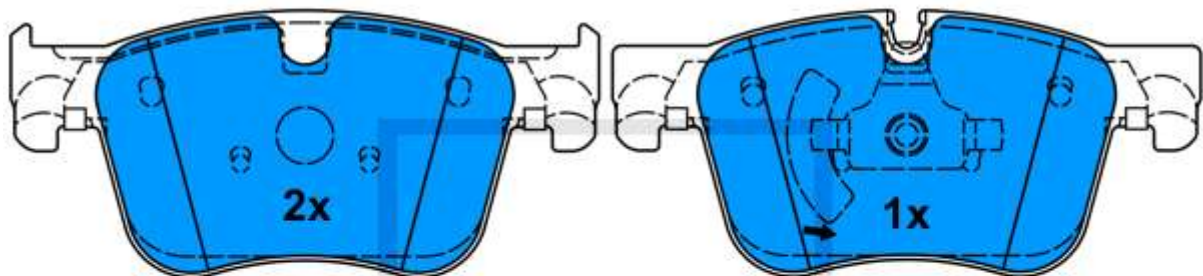

**25833 17,3**

**25834 17,3**

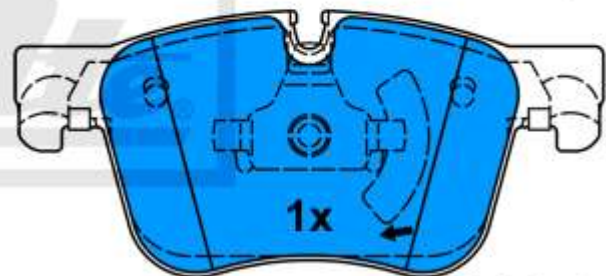

**155,1 x 70,5**

**25834 17,3**